

GENERAL CATALOGUE

2023-2024

peronda

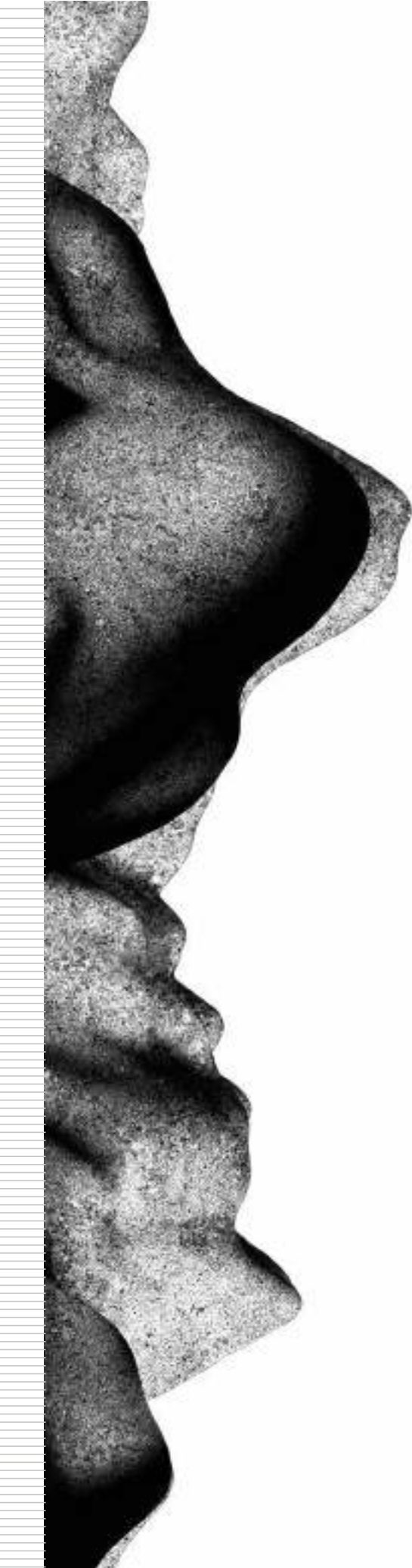

peronda



La evolución tecnológica se dirige hacia un nuevo modelo de comunicación más inmersiva, donde los soportes digitales que nos rodean adoptan una forma flexible, mas líquida y curva rompiendo con el carácter estático con el que fueron ideados.

En Peronda nos hemos desprendido de la rigidez conceptual de nuestras piezas, viajando entre la construcción desnuda y natural del brutalismo y la formas curvilíneas más vanguardistas.

Hemos entendido cada partícula que compone nuestro producto antes de transformarlo en la materia sólida que da cuerpo a nuestras piezas.

Porque la mejor manera de proyectar y moldear el futuro es conociendo el ADN del que estamos originalmente hechos desde nuestros comienzos.

Technology is evolving toward a new more immersive system of communication in which the digital devices that surround us are more flexible, liquid and curved in design, breaking away from the static concept on which they were originally based.

Here at Peronda, we have moved away from rigid conceptual criteria in the creation of our products, gravitating now between stark, natural styles associated with Brutalism and avant-garde curved shapes.

A close understanding of each and every particle of the final makeup of our tiles is achieved before they are transformed into solid matter, giving rise to the final end product.

Because the best way to shape and plan for the future is to be closely familiar with the DNA that forms an integral part of us.

PERONDA

*con el
planeta*

SOSTENIBILIDAD MEDIOAMBIENTAL

Environmental Sustainability



POLÍTICA MEDIOAMBIENTAL

PERONDA GROUP S.A. ha asumido el compromiso de establecer, implantar y mantener un sistema de gestión de la calidad de sus actividades basado en la Norma UNE-EN ISO 14001.

En línea con la filosofía medioambiental de la organización, el principal objetivo de este sistema de gestión es el respeto y la protección del medio ambiente, basado en los siguientes principios:

- Compromiso de cumplir con los requisitos legales y los requisitos aplicables.
- Compromiso con la protección del medioambiente, incluida la reducción y/o prevención de la contaminación.
- Fomentar los procesos innovadores y eficientes, con el objetivo de reducir los impactos ambientales asociados, la contaminación a la atmósfera, las emisiones de CO₂ y los residuos generados.
- Compromiso para aumentar la flexibilidad de los procesos de producción y mejorar la productividad mediante el aumento de la calidad de nuestros productos y la eficiencia de nuestros procesos.
- Compromiso con la formación y sensibilización del personal: Proporcionar formación y sensibilización ambiental continuada a todos los empleados de la empresa con el fin de aumentar y mejorar su competencia profesional, su adaptación a los nuevos cambios y procesos innovadores y mejora de la actitud positiva hacia la sostenibilidad.

La dirección de **PERONDA GROUP, S.A.** se compromete a transmitir y hacer cumplir la política ambiental en todos los niveles de las organizaciones y en todas las etapas del proceso de producción.

ENVIRONMENTAL POLICY

PERONDA GROUP S.A. has committed itself to establishing, implementing and maintaining a quality management system for its activities, based on the UNE-EN ISO 14001 standard.

In keeping with the company's environmental philosophy, the main aim of this management system is to care for and protect the environment, based on the following principles:

- To comply with legal requirements and any other applicable ones.
- To protect the environment, including the reduction and/or prevention of pollution.
- To promote innovative efficient processes in order to reduce associated environmental impacts, atmospheric pollution, CO₂ emissions and generated waste.
- To boost the flexibility of production processes and to improve productivity by raising the quality of Peronda's products and the efficiency of its processes.
- Staff training and a raised environmental awareness: To provide ongoing environmental training to all the company staff in order to boost their professional skills, help them to adapt to new changes and innovative processes, and foster a positive attitude to sustainability.

The Management of **PERONDA GROUP, S.A.** undertakes to make the company's environmental policy known and to ensure compliance with it at all levels of its different organizations and in all stages of the production process.

100% REUTILIZACIÓN

La ecología no es una moda. Ser respetuosos con el medio ambiente es algo que llevamos haciendo desde hace casi dos siglos. Somos conscientes de nuestra responsabilidad como fabricantes y por tanto trabajamos continuamente para minimizar nuestro impacto con el entorno.

No solo somos capaces de producir las piezas cerámicas más innovadoras, nuestro orgullo es poder decir que lo hacemos desde una óptica atemporal de respeto hacia todos aquellos que heredarán nuestro planeta.

100% REUSE

Ecology is not a passing trend. Environmental care has been an intrinsic part of our philosophy for almost two centuries. We are aware of our responsibility as manufacturers. That's why we strive at all times to minimize our impact on the environment.

Not only are we capable of producing amazingly innovative tiles. We are also proud to say that we do it in a forward-looking way by caring for the planet so that future generations can enjoy it.



EFICIENCIA ENERGÉTICA ENERGY EFFICIENCY

Optimización de todas las etapas del proceso productivo, que se traduce en una optimización de la energía consumida y en un aumento de la eficiencia.

- Instalación de recuperadores de calor y quemadores de alta eficiencia para disminuir el consumo térmico y las emisiones de CO2.
- Instalación de luminarias tipo LED que han permitido un ahorro energético de hasta 250.000 kWh/año en consumo de energía eléctrica.
- Instalación de una planta de placas solares para disminuir el consumo eléctrico y las emisiones de CO2.
- Reducción de las emisiones de CO2 debido a la conducción de carretillas elevadoras 100% eléctricas en toda la cadena de producción.

The optimization of all stages of the production process, leading to optimized energy consumption and increased efficiency.

- Installation of high efficiency heat recovery systems in order to diminish thermal demand and CO2 emission.
- Installation of LED lamps which represents a saving of electric energy consumption of 250.000 kWh a year.
- Installation of plant of solar panels to diminish electric consumption and CO2 emissions.
- Reduction of CO2 emission by driving 100% electric forklifts during the whole production line.



EMISIONES ATMOSFÉRICAS ATMOSPHERIC EMISSIONS

Reducción de las emisiones de CO2 a la atmósfera y cumplimiento del Protocolo de Kioto debido a la alta eficiencia energética del proceso productivo.

La reducción del consumo de gas natural durante la producción de las baldosas cerámicas se traduce en una disminución de las emisiones de CO₂ y por lo tanto en una disminución del calentamiento global del planeta y del conocido "efecto invernadero". Todo ello se consigue debido a la aplicación de las tecnologías más avanzadas que hacen del proceso de producción de la empresa un proceso muy eficiente energéticamente.

A reduction in CO2 atmospheric emissions and compliance with the Kyoto Protocol due to the high energy efficiency of the production process.

A reduction in the consumption of natural gas during the tile manufacturing process leads to a drop in CO2 emissions and, by extension, it helps to slow down the global warming caused by greenhouse gas emissions. All this is achieved by using cutting-edge technologies so that the company's production process is a highly energy efficient one.



PROCESOS SOSTENIBLES SUSTAINABLE TECHNOLOGIES

- Utilización de una tecnología limpia basada en el uso de tintas en base agua para la decoración digital de las baldosas cerámicas, evitando la generación de residuos de disolvente y haciendo el proceso de decoración digital más sostenible.

- Todos nuestros productos son envasados en embalajes de cartón 100% reciclados. Anualmente ponemos al mercado un total de más de 600.000 Kg. de cartón reciclado.

- Reducción en un 95% del consumo de plástico debido a la sustitución de embalajes de plástico por embalajes de cartón reciclado en la paquetería comercial.

- Use of clean technologies based on water inks in the ceramic tiles digital decoration. In this way, we avoid solvent waste.

- Every product packing is made of 100% recycled carton. Yearly we place in market more than 600.000 Kg of recycled paper.

- Reduction of 95% of consumption of plastic thanks to replacement of plastic packaging into recycled carton in every parcel.



ECONOMÍA CIRCULAR CIRCULAR ECONOMY

Reutilización de aguas residuales, polvo atomizado y tiesto crudo, generado en el proceso productivo, reduciéndose el consumo de materias primas. Reutilización del 100% del material crudo sobrante. Más de 9.000.000 kg. de material sobrante del proceso de producción reutilizado. (Ver % de recursos reutilizados por colección en la página 8).

Gracias a la reutilización de estos residuos generados en el proceso de fabricación, se disminuye el consumo tanto de agua como de materia prima arcillosa, con lo que se disminuyen las explotaciones para conseguir los recursos naturales utilizados, aumentando su sostenibilidad con el tiempo para que generaciones futuras puedan optar a ellos.

Re-using wastewater, particles of powder and unfired waste clay in the production process, hence reducing the consumption of raw materials. We reuse the 100% of wasted raw material during the production process. More than 9.000.000 Kg of wasted material is reused in a year. (See page 8 for the percentage of re-used raw materials per collection).

By re-using these waste products from the production process, savings on water consumption and clay raw materials are achieved, thus reducing the amount of natural resources that need to be harvested and helping to conserve them for future generations.



GESTIÓN DE RESIDUOS WASTE MANAGEMENT

Minimización de los impactos ambientales generados durante nuestro proceso de producción.

Como todo proceso de producción, la fabricación de baldosas cerámicas genera una serie de residuos, que son gestionados mediante gestores autorizados, reduciéndose de este modo los impactos medioambientales asociados.

- 100% de reciclado del plástico, cartón y flejes sobrantes del proceso de producción.

- Las baldosas cerámicas tienen una vida útil de 50 años lo que se traduce en una falta de generación de residuos sólidos durante todo ese tiempo.

- Adhesión a ECOEMBES – entidad sin ánimo de lucro encargada de la recuperación de envases en toda España.

The minimization of all environmental impacts from the production process.

Like all production processes, a series of waste materials are generated during the tile manufacturing process. These are managed by authorized waste management agencies, hence reducing associated environmental impacts.

- 100% recycling of plastic, carton and strapping wasting during production.

- Ceramic tiles have a service life of more than 50 years and this fact reduces solid waste during all this time.

- Joining ECOEMBES – Nonprofit organization that cares for the environment through recycling packaging in Spain.



VERTIDO CERO ZERO DISCHARGE

Reutilización del 100% de las aguas residuales procedentes del proceso productivo. Más de 18.000.000 litros de agua anuales reciclados.

La generación de las aguas residuales es un aspecto medioambiental significativo en el proceso de fabricación de baldosas cerámicas. Se debe principalmente a las operaciones de limpieza y aplicación de los esmaltes. Estas aguas residuales se reutilizan en el proceso de producción al preparar las materias primas arcillosas necesarias para el conformado del soporte cerámico. Por lo tanto no existe vertido de aguas residuales, que se conoce como vertido cero.

We reuse the 100% of wastewater coming from the production process. More than 18.000.000 liters are recycled yearly.

Wastewater generation is an important environmental factor in ceramic tile manufacturing. This wastewater mainly comes from cleaning operations and the glazing process. Peronda re-uses wastewater in the production process as a raw material in the preparation of the clay materials used to make the tile bodies of its products, involving wet-milling and spray-drying processes. This means that there is no discharge of wastewater, technically known as zero discharge.



VIDA ÚTIL SERVICE LIFE

Las baldosas cerámicas son uno de los materiales de la construcción de mayor vida útil, reduciendo de este modo el volumen de residuos generados.

La vida útil de una baldosa cerámica se estima en 50 años, con lo que se consigue que el impacto ambiental asociado a cada una de ellas sea bajo. La larga vida útil que presentan se traduce en una disminución de los residuos sólidos o de demolición generados. Además, y debido a que es inerte, no requiere de consumos energéticos para su correcto funcionamiento cuando está instalada en cualquier edificio, con lo que se disminuyen aún más los impactos medioambientales asociados.

Ceramic tiles are one of the building materials with the longest service life, thus reducing the amount of waste that is generated.

Ceramic tiles have an estimated service life of 50 years, and so each tile has a low environmental impact. This long service life leads to a decrease in generated solid waste or debris from demolitions. Moreover, because ceramic tiles are inert products, they require no energy consumption once they have been laid in buildings, further minimizing the associated environmental impacts.

ECONOMÍA CIRCULAR

Todos los productos de la marca PERONDA están fabricados siguiendo un modelo de producción basado en la ECONOMÍA CIRCULAR, en concreto en la reutilización de las aguas residuales de proceso, reutilización de los residuos de atomizado utilizados y en el uso de material reciclado en el conformado de las baldosas cerámicas. Esta metodología de fabricación está en línea con la filosofía sostenible seguida por la empresa en todas sus actividades basada en la minimización del consumo de recursos naturales y desechos generados y priorizando el uso de materiales reciclados con el fin de minimizar el impacto ambiental.

Todas las referencias fabricadas en PERONDA contienen un % de material reciclado certificado mediante la norma ISO 14021, logrando obtener productos más sostenibles y respetuosos con el medio que nos rodea.



PORCELÁNICO PORCELAIN

Formato Format cm	Formato Format inch	% Reciclado Recycled
100 x 100 x 0,6	39 3/8 x 39 3/8 x 1/4	39%
100 x 100 x 0,8	39 3/8 x 39 3/8 x 5/16	35%
100 x 100 x 2	39 3/8 x 39 3/8 x 13/16	36%
50 x 100 x 2	19 11/16 x 39 3/8 x 13/16	36%
100 x 180 x 0,6	39 3/8 x 70 7/8 x 1/4	40%
100 x 180 x 0,8	39 3/8 x 70 7/8 x 5/16	35%
15 x 90 x 1	5 7/8 x 35 7/16 x 3/8	42%
19,5 x 121,5 x 1	7 11/16 x 47 13/16 x 3/8	42%
23 x 180 x 1,1	9 1/16 x 70 7/8 x 7/16	42%
24 x 151 x 1	9 7/16 x 59 7/16 x 3/8	42%
30 x 30 x 0,8	11 13/16 x 11 13/16 x 5/16	42%
45,2 x 45,2 x 0,87	17 13/16 x 17 13/16 x 5/16	42%
60 x 60 x 1	23 5/8 x 23 5/8 x 3/8	42%
60 x 120 x 1	23 5/8 x 47 1/4 x 3/8	42%
75,5 x 151 x 1	29 3/4 x 59 7/16 x 7/16	42%
90 x 90 x 1	35 7/16 x 35 7/16 x 3/8	42%
45 x 45	17 11/16 x 17 11/16 x 3/8	35%
33 x 33	13 x 13 x 3/8	35%

CIRCULAR ECONOMY

All products sold under the PERONDA brand name are manufactured in accordance with a CIRCULAR ECONOMY production model and, more specifically, the re-use of wastewater in the process, the re-use of waste spray-dried powder, and the use of recycled materials in the composition of the tiles. This manufacturing model is coherent with the sustainable philosophy followed by the company in all its activities, based on the minimized consumption of natural resources and generated waste and on the prioritized use of recycled materials in order to keep the company's environmental impact to a minimum.

Every product reference in PERONDA contains some % of recycled material (certified by ISO 14021), achieving a more sustainable and environmental friendly product range.

GRES SINGLE FIRED FLOOR

Formato Format cm	Formato Format inch	% Reciclado Recycled
45 x 45	17 11/16 x 17 11/16 x 3/8	35%
33 x 33	13 x 13 x 3/8	35%

REVESTIMIENTO WALL TILES

Formato Format cm	Formato Format inch	% Reciclado Recycled
20 x 40 x 1,03	7 7/8 x 15 3/4 x 3/8	50%
25 x 75 x 1,05	9 13/16 x 29 1/2 x 7/16	56%
32 x 90 x 1,05	12 5/8 x 35 7/16 x 7/16	50%
33 x 91 x 1,05	13 x 35 13/16 x 7/16	50%
33,3 x 100 x 0,75	13 1/8 x 39 3/8 x 1/4	50%
33,3 x 100 x 0,86	13 1/8 x 39 3/8 x 5/16	50%

CERTIFICADOS

CALIDAD QUALITY



Sistema de gestión de la calidad basado en la norma internacional ISO 9001. Certifica la mejora continua de todos los procesos, productos y servicios de la organización con el objetivo de aumentar la satisfacción de todas nuestras partes interesadas.

Quality management system in compliance with ISO 9001 norm. Certifies a continuous improvement of processes, products and services, the objective of which is the complete satisfaction of all our involved parties.



Declara la conformidad de nuestros productos con los requisitos establecidos en el Marcado CE que establece que un producto es evaluado antes de ser introducido en el mercado y que cumple con los requisitos de seguridad, salud y protección medioambiental aplicables.

This declares that our products comply with the stipulations of the CE marking, under which a product must be assessed before it is put on sale and comply with the applicable health, safety and environmental requirements.



El Certificado CCC es un sistema de certificación obligatorio para las exportaciones a China que garantiza que los productos con baja absorción de agua (E<0.5%) cumplen con los requisitos de seguridad y calidad establecidos.

The CCC certificate is compulsory for products exported to China. It guarantees that products with a low water absorption rate (E<0.5%) comply with the safety and quality requirements.



Es una certificación de aprobación de productos, emitido por el Instituto Francés CSTB, y verifica la idoneidad técnica de productos de primera calidad en relación al tipo de uso destinados.



This is a product approval certificate, issued by the French Institute CSTB, who verifies the technical suitability of top quality products in relation to the type of use intended.



Se trata de una marca de calidad requerida por Arabia Saudí para poder realizar exportaciones al país. Esta marca de calidad esta regulada por el SASO (Organización Saudita de Estándares, Metrología y Calidad).

It is a quality mark required by Saudi Arabia to be able to carry out exports to the country. This quality mark is regulated by SASO (Saudi Arabian Standards, Metrology, and Quality Organization).

CERTIFICATES

MEDIO AMBIENTE ENVIRONMENT



Sistema de gestión medioambiental basado en la norma internacional ISO 14001. Sistema que certifica el cumplimiento de todos los requisitos legales de aplicación y garantiza la minimización de los impactos ambientales asociados a los procesos de la organización en línea con nuestro compromiso de sostenibilidad.

Environment management system in compliance with the UNE-EN ISO 14001 standard. Certifying system for application requirements which guarantee minimization of environmental impact, according to our commitment to sustainability.



Es una Declaración Ambiental de Producto de conformidad con la Norma UNE-EN ISO 14025, que proporciona información medioambiental basada en el ciclo de vida de nuestros productos.

An Environmental Product Declaration in compliance with the UNE-EN ISO 14025 standard, which provides environmental info based on the lifecycle of our products.

CERTIFICACIÓN

LEED

BREEAM

Sistemas de certificación de edificios "ecológicos". Promueven la construcción de edificios sostenibles en base a prácticas de construcción más respetuosas con el medioambiente. Todas las baldosas cerámicas contribuyen a una edificación/construcción más sostenible de los edificios y a la obtención de puntos LEED y BREEAM. Con ello se consigue un aumento de la calidad de vida y el bienestar de los habitantes de este planeta mediante el logro en las viviendas y edificios de ambientes interiores más saludables.

Sustainable building certification systems developed by US Green Building (LEED) and Building Research Establishment (BREEAM), which promote the "ecologic" buildings, using environmental-friendly constructional practices.



Etiqueta medioambiental para el mercado francés que informa sobre el contenido en COV's (Compuestos Orgánicos Volátiles). Declara que nuestros productos son de tipo A+, contribuyendo a un hábitat sano y respetuoso con el medioambiente.

An environmental label for the French market, which provides information on the VOC content (volatile organic compounds). It declares that our products are rated A+, contributing to a healthy environmentally-friendly habitat.

NOMAD SYSTEM

NIMD SYSTEM

Time to renew.

+ NOMAD es la solución revolucionaria de construcción en seco de Peronda, que usa un innovador sistema de sujeción magnética: Simple, funcional, ecológico.

+ NOMAD aplica un recubrimiento **ferromagnético** a la cerámica. La instalación de las piezas se realiza sobre superficies capaces de generar adhesión magnética permanente e inocua para la salud.

+ La cerámica magnética de NOMAD aúna **sostenibilidad y rentabilidad**.

PERONDA ofrece con NOMAD una **mejora operativa**, por la combinación de la reducción del tiempo de montaje y la ausencia de residuos. Y esto se une a los nuevos usos del material, gracias a que NOMAD **permite una fácil reutilización de las piezas**.

+ NOMAD is Peronda's revolutionary dry tile-laying solution, based on an innovative magnetic anchorage system. It is simple, functional and eco-friendly.

+ With NOMAD, a **ferromagnetic** coating is applied to the ceramic tiles. The tiles are then laid on surfaces able to create a permanent tight magnetic bond, with no harmless effects on people's health.

+ NOMAD's magnetic tiles unite **sustainability with higher cost-effectiveness**.

With this system, Peronda **guarantees easier installation processes** through a reduction in assembly times and no building residues.

The tiles can also be repurposed because, thanks to NOMAD, **they can easily be re-used elsewhere**.

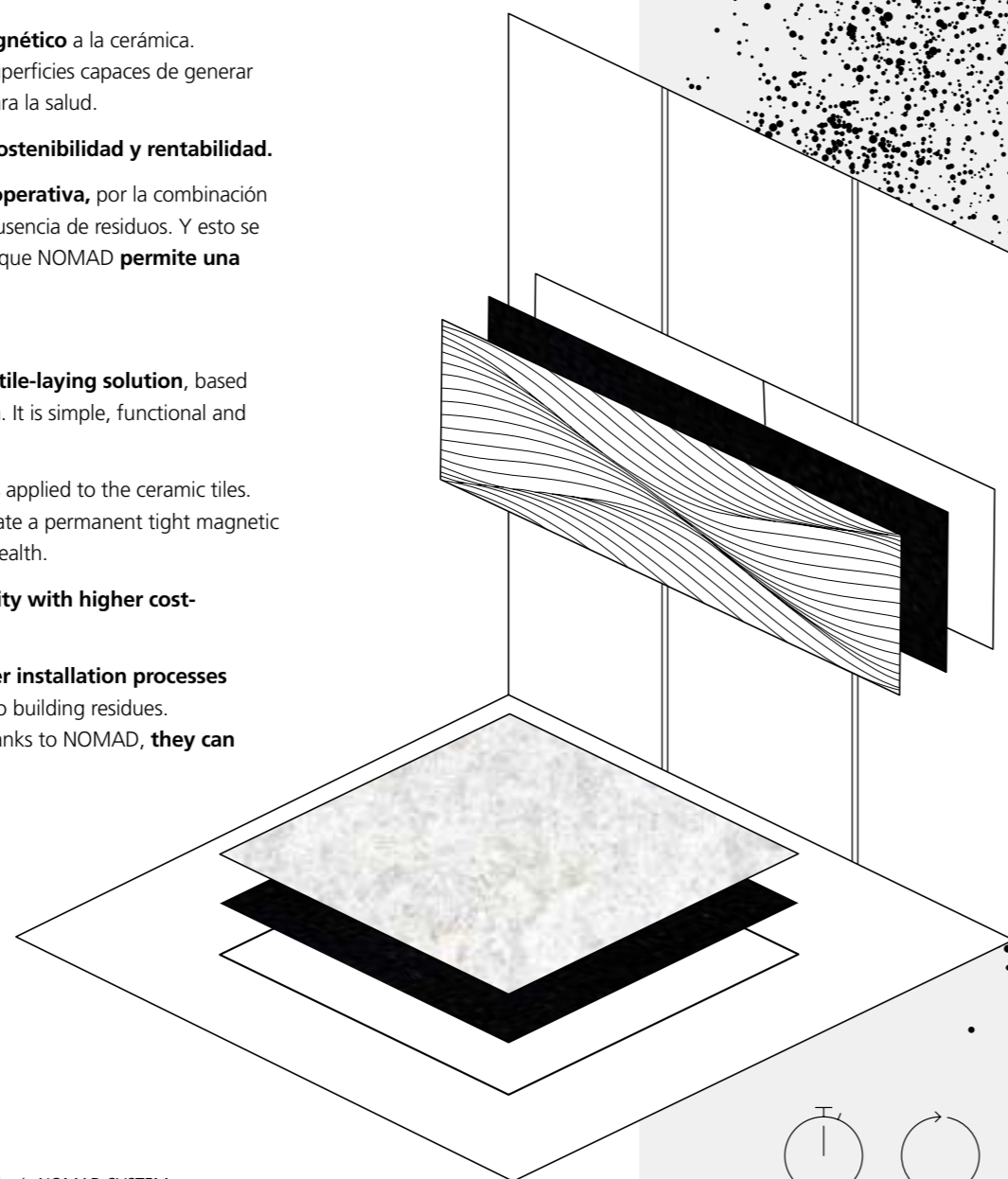

Accede al código QR y conoce a fondo nuestra tecnología NOMAD SYSTEM. Enter with the QR code and learn all about our NOMAD SYSTEM technology.

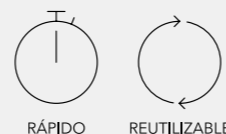

SHAPED TECH

Real precision.

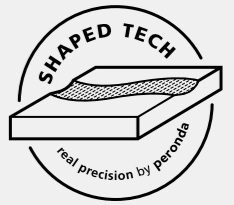

Natural

Las texturas, los recovecos, las vetas que crea la naturaleza son caprichosas, y esa es la fuente de su belleza. No hay dos iguales, y en su singularidad radica su belleza.

La pasión por la búsqueda del detalle ha llevado a Peronda a desarrollar una tecnología capaz de reproducir la naturaleza en su máxima expresión, que es captando hasta el mínimo detalle.

Los relieves son creados con tecnología digital perfectamente coordinada con la impresión gráfica para generar las piezas más naturales vistas en cerámica.

Preciso

Donde ponemos el relieve ponemos la tinta. La precisión con la que imprimimos nuestras piezas es milimétrica, pues relieve y gráfica casan a la perfección para obtener un resultado técnicamente inmejorable.

Real

Nada de ilusiones ópticas, esto es real. Lo que ves y lo que tocas es lo mismo. La veta está donde está el relieve y viceversa. Lo que siempre quisimos en cerámica, ahora lo consigue Peronda.

Natural

The textures, sinuosity and veining found in nature all follow capricious rules, and it is this random nature that makes them so very lovely. Nothing is ever identical and this singularity is the secret to nature's beauty.

Peronda's passion for detail has led it to develop technology able to reproduce nature in its maximum of expressions, captured down to the tiniest of details.

Digital technology is used to create textures that coincide perfectly with the printed pattern, leading to some of the most natural looking designs ever to be seen on ceramic tiles.

Precise

Our printing inks reach each and every part of the printed texture. The tiles are printed with absolute precision, carefully marrying the design with the corresponding texture to unparalleled technical effect.

Real

There are no optical illusions. Everything is real. What you see and what you touch are one and the same thing. The printed veins coincide perfectly with the texture. Everything you have always longed for in ceramic tiles has now been achieved by Peronda.

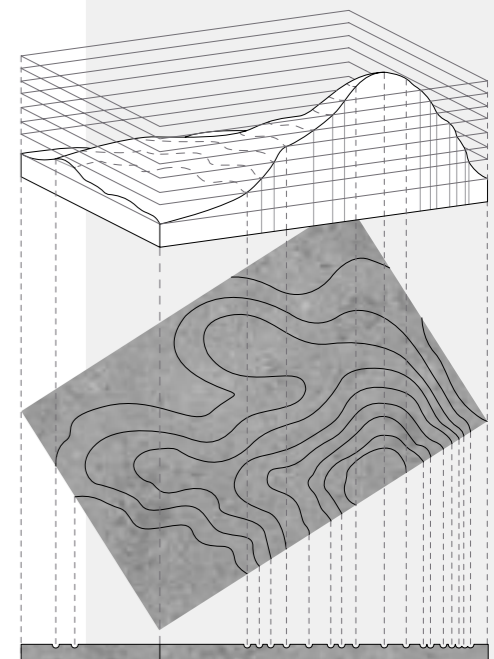

Accede al código QR y conoce a fondo nuestra tecnología SHAPED TECH. Enter with the QR code and learn all about our SHAPED TECH technology.

20MM

*Extraordinary
resistance.*

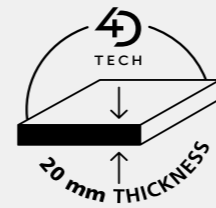

Lo más robusto de Peronda

La última tecnología en producción cerámica se materializa en 20 mm, el porcelánico de mayor espesor con todos los beneficios de 4D Tech en el producto más robusto de Peronda.

Mayor espesor sin costilla

Somos pioneros en producir piezas de este espesor con prensa continua. Además de todas las características de un producto 4D, 20 mm permite la ausencia de costilla en la pieza.

Resistencia Extraordinaria

La base plana del 20 mm ofrece un total contacto con la superficie de soporte. Sobre plots u otro material, el resultado es más resistente, pues toda la pieza absorbe el impacto

Peronda's most robust

The latest technology in ceramic production becomes a reality in 20 mm. The thickest porcelain with all the benefits of 4D Tech in Peronda's most robust product.

Thicker without ribbing

We are pioneers in producing pieces of this thickness with continuous press. Besides all the features of a 4D product, 20 mm allows for the lack of ribbing.

Extraordinary resistance

The flat base of 20 mm offers complete contact with the supporting area. Be it on plots or any other material, it is more resistant since the whole piece absorbs the impact.

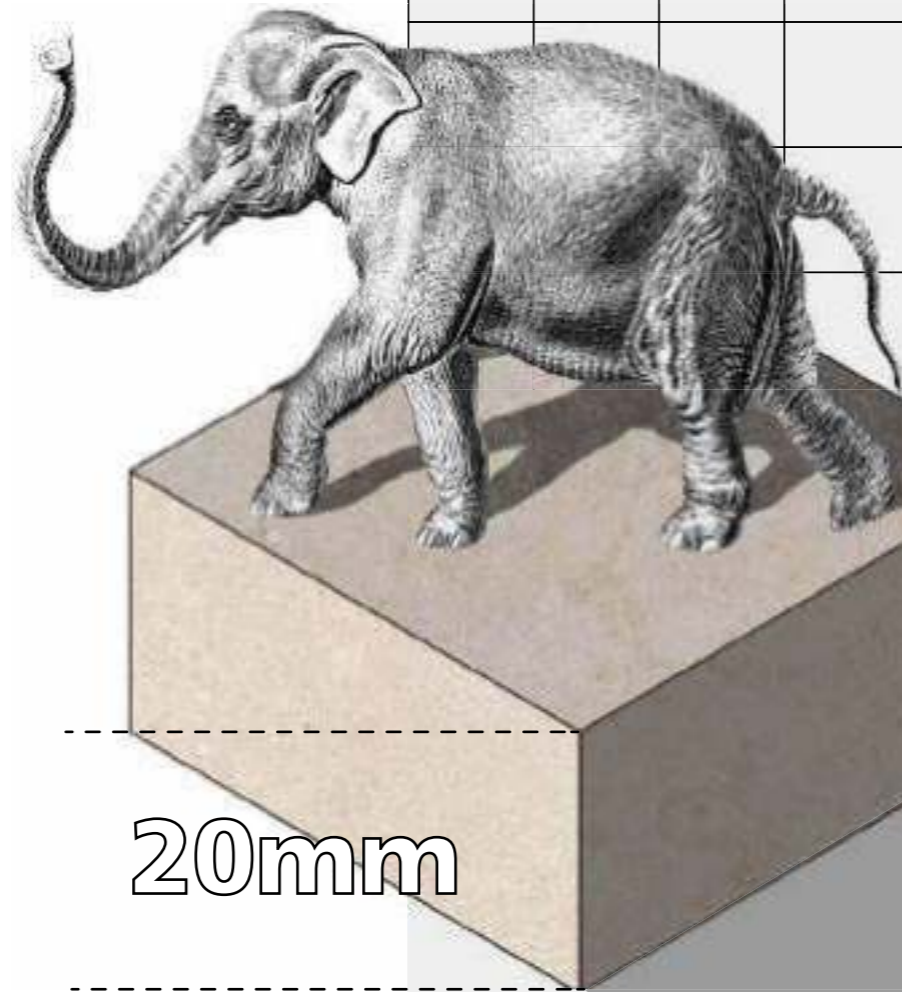

20mm

ALL IN ONE

*Antislip soft.
Unlimited purposes.*



Usos ilimitados. Misma superficie

¿Imaginas poder tener un mismo suelo con iguales cualidades en todos los espacios de tus proyectos? El acabado All in one aúna suavidad y antideslizamiento. Ahora no hay por qué elegir, puedes tenerlo todo en un único producto.

Mejoras destacadas:

Zonas húmedas ahora son más suaves y fáciles de limpiar gracias al nuevo acabado de Peronda.

El nuevo acabado All in one de Peronda permite reducir el stock al satisfacer diversas necesidades técnicas con una sola referencia.

Mayor armonía al poder transitar del salón a la terraza sin preocuparse por los formatos o tonos, gracias a la colocación sin límites que brinda continuidad estética.

Unlimited purposes. Same surface

Can you imagine having the very same flooring with identical features in every single space of your project? All in one finish brings softness and anti slip treatment together. There is no need to choose any more. You can have it all in just one product.

Highlights:

Humid areas are now smoother and easier to clean with Peronda's new finish, providing increased softness and cleanliness.

Peronda's new finish, All in one, allows for stock reduction by offering a single product that meets various technical requirements for your project.

The freedom of placing materials without limitations creates a sense of aesthetic continuity, enabling seamless transitions from the living room to the terrace, irrespective of formats or tones.



Accede al código QR y conoce a fondo nuestra tecnología ALL IN ONE. Enter with the QR code and learn all about our ALL IN ONE technology.

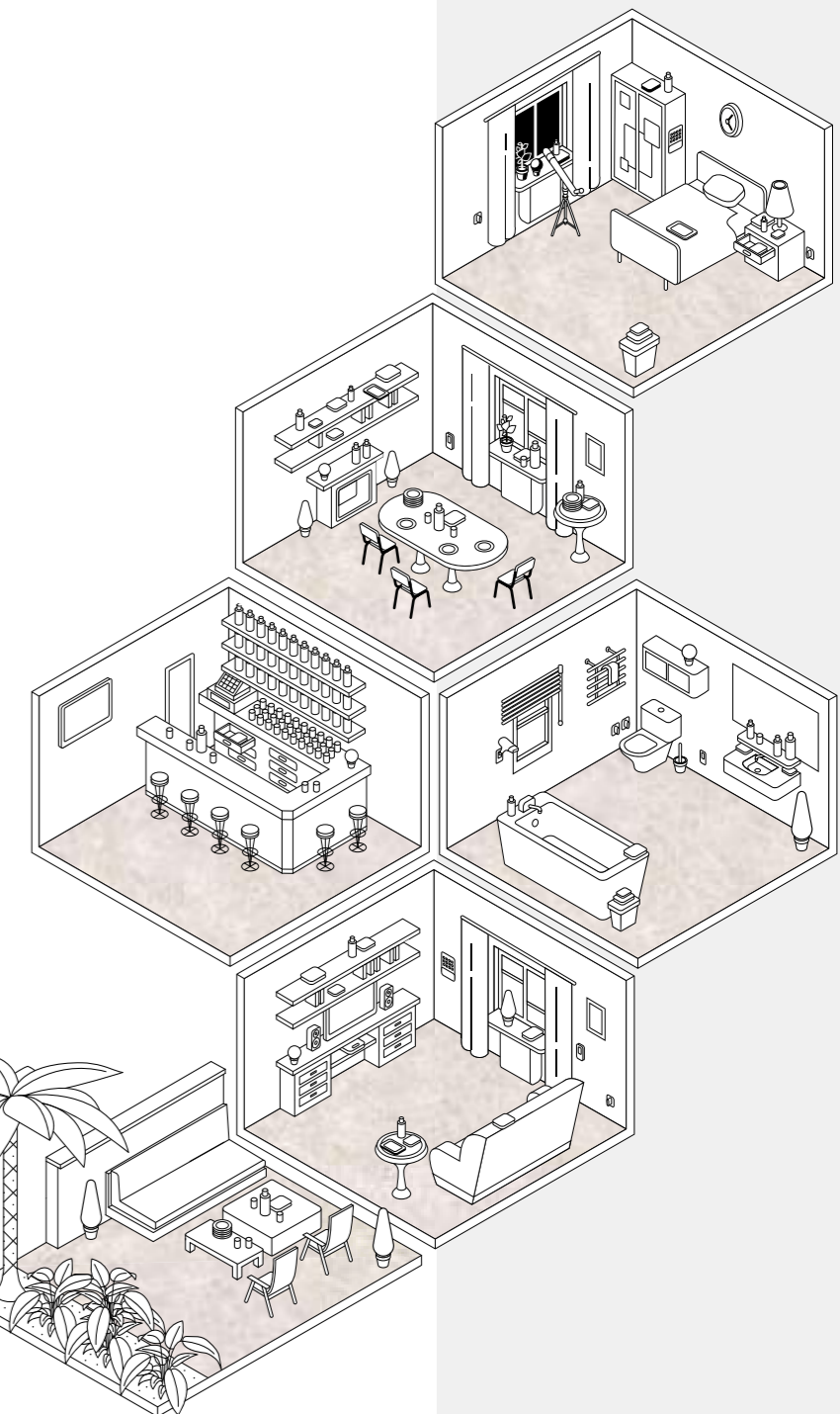

DEEP TECH

*Maximum
relief*



Permite realizar relieves con un nivel de profundidad extraordinario, llegando hasta los 8 mm de relieve.

Esta nueva tecnología abre un universo de posibilidades decorativas

Relief surfaces can be created with an extraordinary depth, with reliefs as deep as 8 mm.

This new technology opens up new broad-ranging decorative potential.

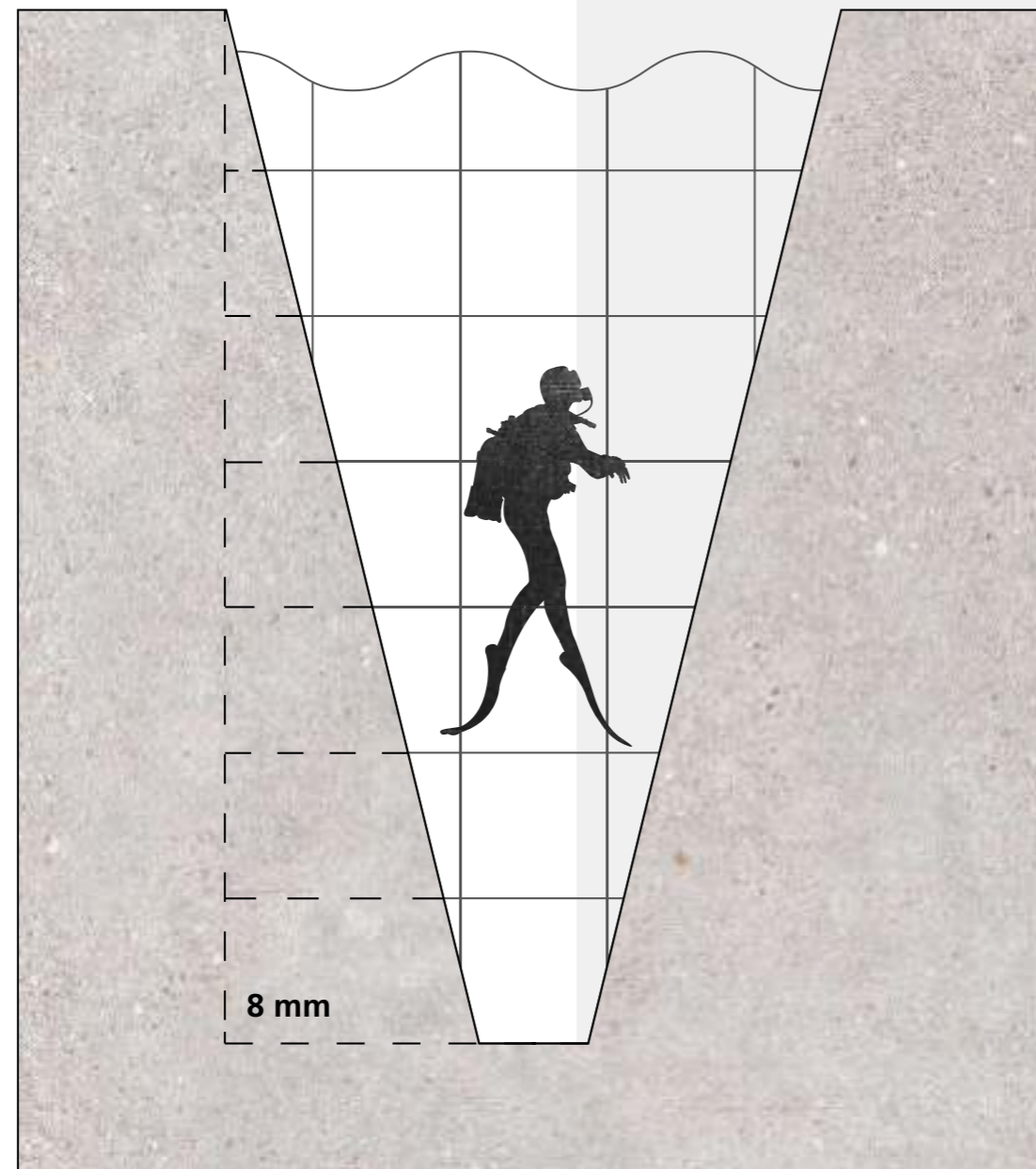

LAYER TECH

*Multi texture
surface.*

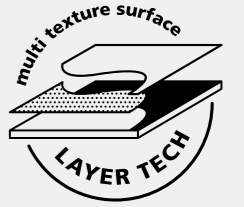

Layer Tech es la última tecnología de decoración cerámica, que permite crear texturas en diferentes capas de la superficie generando efectos variados en una misma pieza. Acabados espectaculares hasta ahora imposibles de conseguir en cerámica.

Con esta técnica se abre un infinito abanico de posibilidades en decoración cerámica puesto que se trata de combinar distintas materias, colores y formas en un proceso de adición en el que cada combinación puede generar un efecto totalmente nuevo y sorprendente.

Layer Tech is the latest in tile printing technology. With it, textures can be created on different surface layers, generating varying effects on the same tile. This leads to hitherto unimaginable spectacular finishes on the tiles.

Layer Tech technology opens up endless new possibilities in ceramic tile printing, since different materials, colours and shapes can be combined. In this additive process, each combination gives rise to a totally new amazing effect.

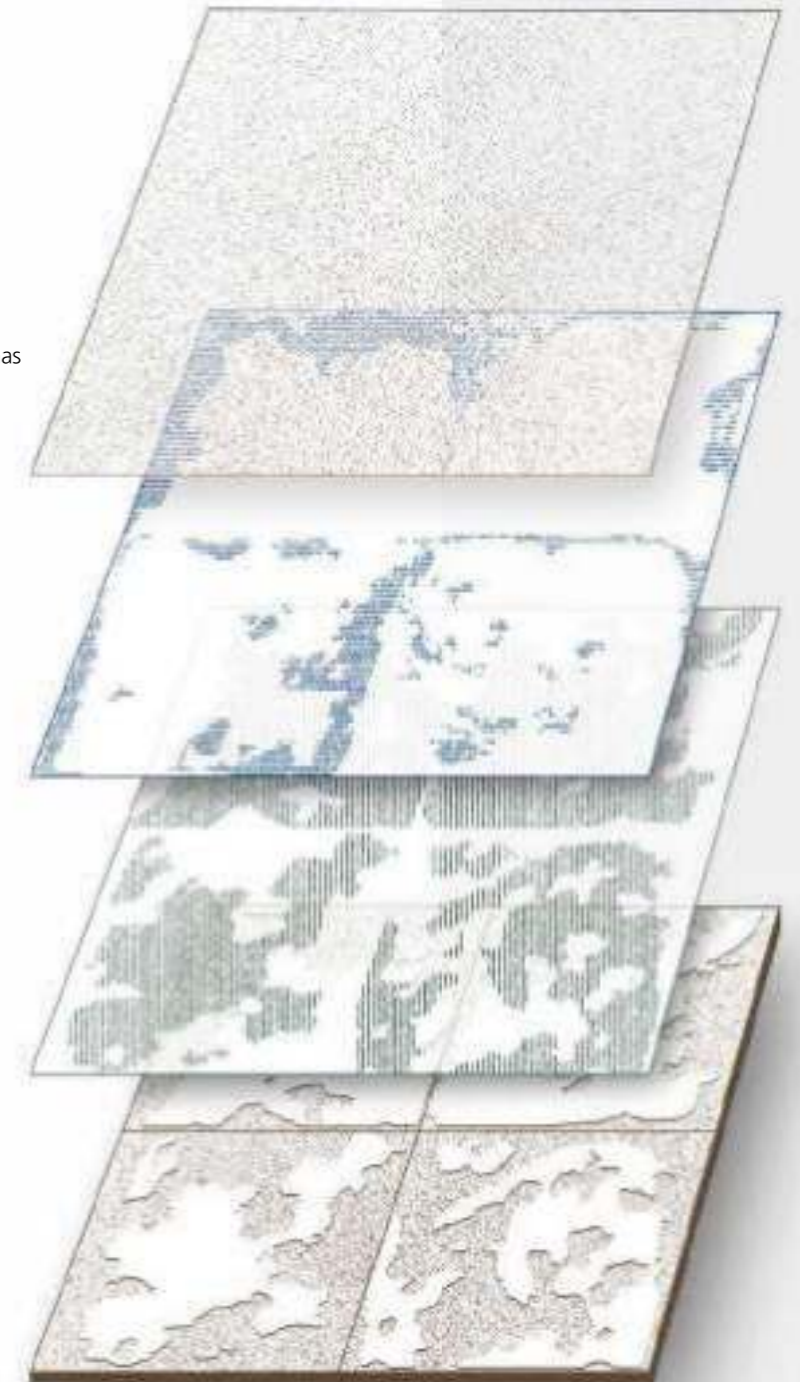

Accede al código QR y conoce a fondo nuestra tecnología LAYER TECH.
Enter with the QR code and learn all about our LAYER TECH technology.

SOFT

The smoothest one.



Suave, sedoso y fácil de limpiar

El acabado SOFT es la perfecta elección para hacer de cualquier espacio un lugar más confortable.

Gracias a su material sedoso, ofrece una superficie de extrema suavidad muy fácil de limpiar, pues impide que la suciedad se adhiera.

El broche ideal para tu vivienda o local comercial.

Smooth, silky and easy to clean

SOFT is a finish conceived to bring added comfort and convenience to settings of all kinds.

Thanks to its silky feel, this is a very smooth, easy-to-clean surface since it prevents the build-up of dirt.

The perfect crowning touch to homes or commercial premises!



EXTRA WHITE



Con todos los esfuerzos tecnológicos concentrados en nuevas formulaciones de esmaltes, podemos ofrecer el blanco cerámico más puro hasta la fecha, que cuenta además con una suavidad incomparable.

Se trata del acabado Extrawhite presente en las colecciones ICE y COTTON. Los espacios se tornan más luminosos, neutros y confortables aportando así el valor diferencial que continuamente ofrecen nuestros productos, resultado de nuestra conocida pasión por el detalle.

Thanks to the technological efforts we channel into finding new glaze formulae, we have come up with the most ultra-white tile finish to date, with the added benefit of an unparalleled smooth surface.

This is our Extrawhite finish, available in the ICE and COTTON collections. Extrawhite infuses settings with a more luminous, neutral, comfortable appearance, lending them that singular appeal that all our products offer, thanks to Peronda's well-known passion for detail.

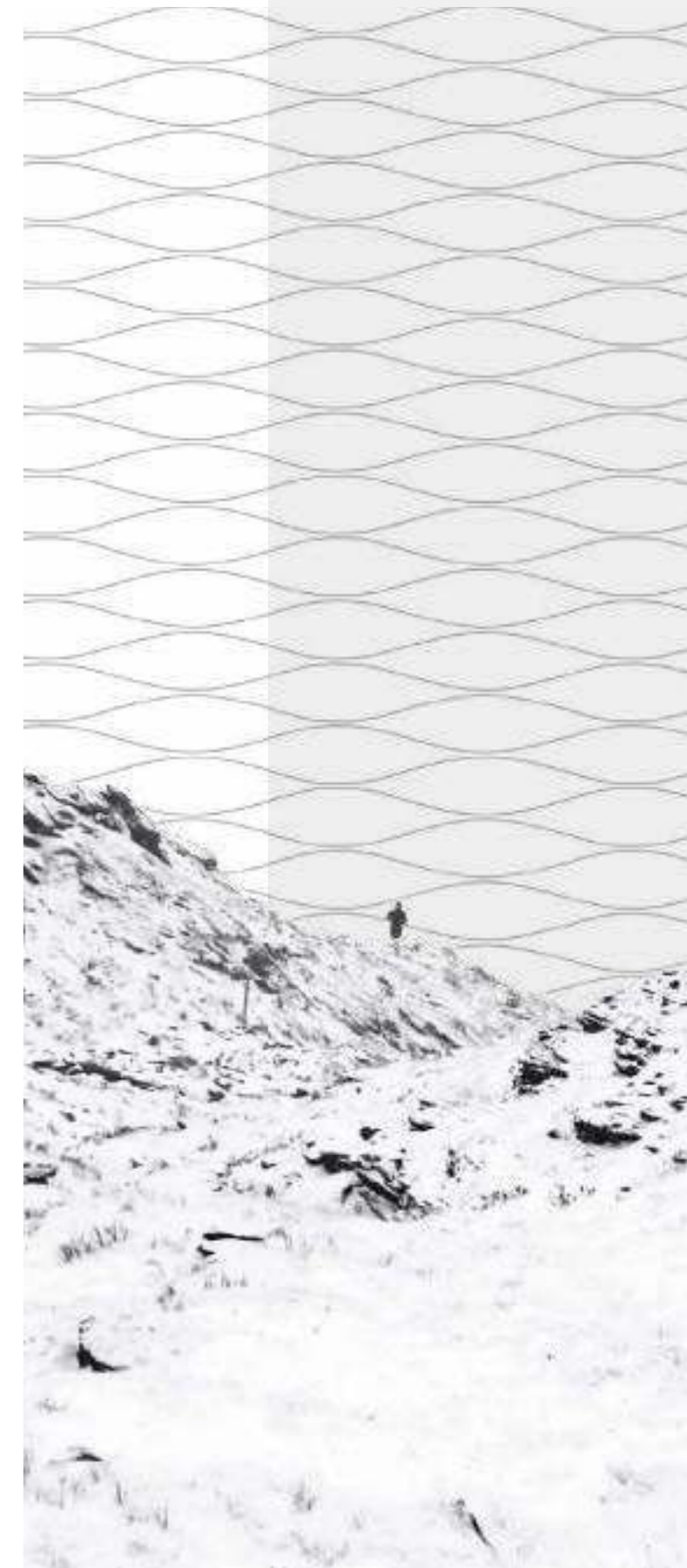

4D TECH



MAYOR NATURALIDAD
A more natural appearance

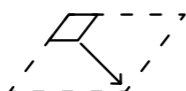

PIEZAS DE MAYOR TAMAÑO
Larger formats

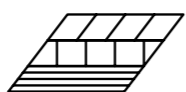

DECORACIÓN DIGITAL EN MASA
Through-body digital decoration

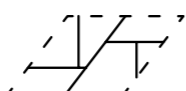

VARIEDAD DE FORMATOS
More widely assorted formats



VARIEDAD DE ESPESORES
Varying thicknesses

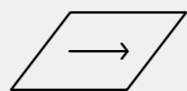

FABRICACIÓN EN PLANO CONTÍNUO
Continuous production process



CORTE POR CUCHILLA EN CRUDO
Tiles cut while unfired



MEJOR DECORACIÓN DIGITAL SUPERFICIAL
Improved digital surface décor

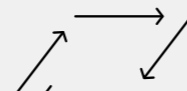

ECOLOGÍA
Eco-friendly



DURABILIDAD
Durability

El futuro cerámico no es qué. Es cómo

4D TECH es el sistema de producción cerámica más innovador del mercado. Un nuevo estándar para la máxima calidad.

El nuevo Peronda de siempre

Nueva tecnología, mismos valores. 4DTECH aporta mayor precisión, versatilidad y eficiencia sin olvidar la calidad y la sostenibilidad.

With technology as our ace card

4D TECH is the most innovative tile manufacturing system on the market, raising standards in a bid to achieve maximum quality.

A new yet familiar Peronda

New technology but still the same values. 4DTECH ensures greater precision, versatility and efficiency, not to mention quality and sustainability.

HONED

The value of the passing of time.

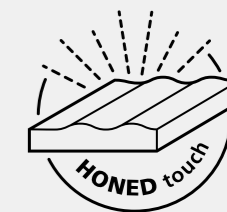

Eterno

Brillo satinado irregular que nos evoca el resultado del paso del tiempo sobre una superficie noble.

La belleza de los elementos que cuanto más envejecen mayor valor tienen, más bonitos son, más historias atesoran.

Todo ello ligado a un tacto especialmente suave que transforma cualquier interior en un lugar especial, cálido, donde nos sentimos cómodos y seguros.

Eternal

Uneven polished brightness evoking the result of the passing of time on a fine surface. The beauty of elements that the more they get old, the more value they have, the more beautiful they are and the more number of stories they treasure.

All of this is bound to quite a soft touch that turns any indoor area into a special, warm place where we feel safe and comfortable.



Accede al código QR y conoce a fondo nuestra tecnología HONED. Enter with the QR code and learn all about our HONED technology.

dimen^{4D}
sion

defini^{4D}
tion

desi^{4D}
gn

distin^{4D}
ction

PERONDA

.com

HERRAMIENTAS DIGITALES DIGITAL TOOLS

En Peronda estamos comprometidos con el detalle a todos los niveles, por ello te ofrecemos diferentes maneras de vivir la experiencia de la marca, ahora, a nivel digital. También pensamos en facilitarte la experiencia de venta con tus clientes. Por ello ponemos a tu disposición, en www.peronda.com/3D, un sencillo programa para que puedas inspirar con toda la oferta de Peronda. Simplemente selecciona un ambiente, marca la superficie que quieras y elige un producto. En menos de un minuto estarás mostrando multitud de propuestas estéticas que seguro ayudarán a conquistar los deseos de tu cliente.

Peronda is committed to detail at every level, which is why we offer you different ways of experiencing the brand – the latest one online! We've also given a lot of thought about how to enhance the sales experience with your customers. We therefore offer a simple programme at www.peronda.com/3D where you can inspire them with the full range by Peronda. Simply select a setting, enter the surface area you want, and choose a product. In less than one minute you can show them all kinds of aesthetic ideas that are bound to help you fulfil your customers' wishes

SOTWARE 3D

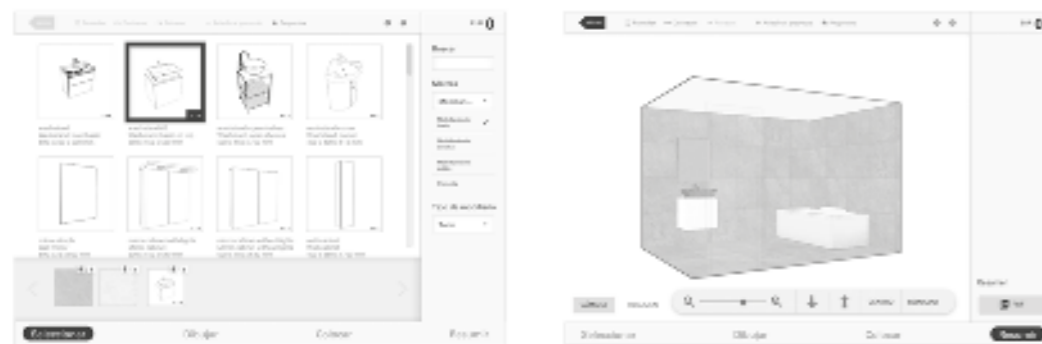

Accede al código QR y diseña tu propio espacio con nuestro CONFIGURADOR 3D.
Enter with the QR code and design your own space with our 3D SETTINGS VISUALIZER.

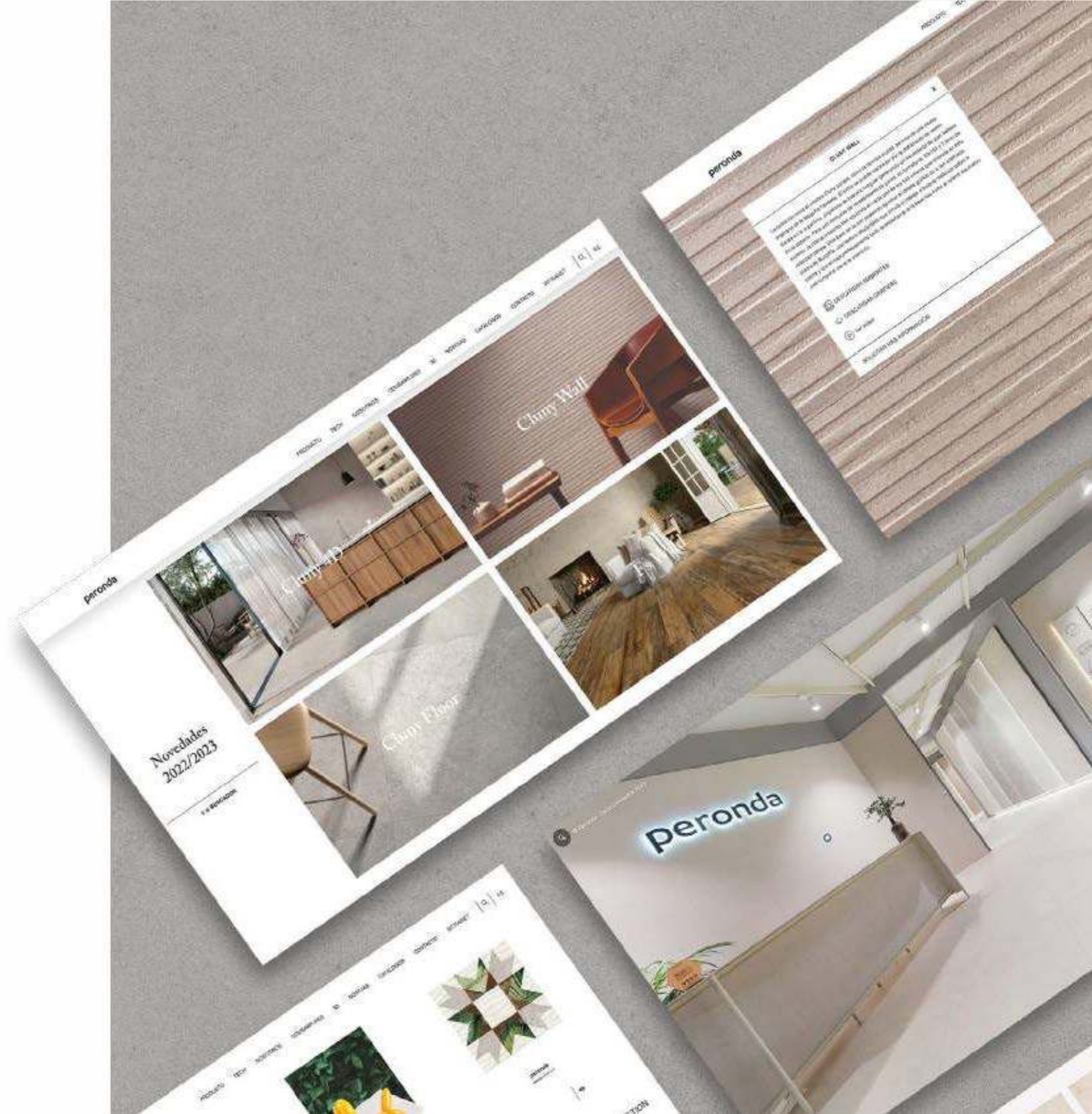

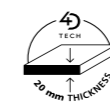

20 MM

Porcelánico espesorado realizado con la última tecnología en producción cerámica. Todos los beneficios de 4D Tech al servicio del producto más robusto de Peronda.

20 mm thick porcelain made with the latest technology in ceramic production. All the benefits of 4D Tech at the service of Peronda's most robust product.



ALL IN ONE _AS

Usos ilimitados, misma superficie. El acabado All in one aúna suavidad y antideslizamiento. Ahora no hay por qué elegir, puedes tenerlo todo en un único producto.

Unlimited purposes, same surface. All in one finish brings softness and anti slip treatment together. There is no need to choose any more. You can have it all in just one product.



SHAPED _SP

Relieves creados de manera digital perfectamente coordinados con la impresión gráfica para generar las piezas más naturales nunca vistas en cerámica.

The latest in tile printing technology. With it, textures can be created on different surface layers in a digital way.



HONED _HO

Brillo satinado irregular que nos evoca el resultado del paso del tiempo sobre una superficie noble.

Uneven polished brightness evoking the result of the passing of time on a fine surface.



SOFT _SF

Acabado suave y sofisticado en superficies mates de fácil limpieza que enfatiza el detalle del producto.

A soft sophisticated matt finish, conceived to enhance the features of the tile design, on an easy-to-clean surface.



LAYER TECH _LT

Última tecnología de decoración cerámica, que permite crear texturas en diferentes capas de la superficie de manera digital.

The latest in tile printing technology. With it, textures can be created on different surface layers in a digital way.



DEEP TECH _DT

Permite realizar relieves con un nivel de profundidad extraordinario, llegando hasta los 8 mm de relieve.

Relief surfaces can be created with an extraordinary depth, with reliefs as deep as 8 mm.



EXTRAWHITE

Gracias a los esfuerzos tecnológicos concentrados en nuevas formulaciones de esmaltes, podemos ofrecer el blanco cerámico más puro hasta la fecha.

Thanks to the technological efforts we channel into finding new glaze formulae, we have come up with the most ultra-white tile finish to date.

NATURAL _NT

Acabado inherente al producto cerámico cuidando los atributos naturales del mismo para potenciar el detalle de su gráfica.

The tile's natural finish, conserving all its natural characteristics so as to enhance the details of its pattern.

LAPADO _LA

Superficies semipulidas que aportan brillo natural a cualquier tipo de espacio.

A semi-polished surface that brings a natural shine to all settings where it is used.

ANTISLIP _A

Porcelánicos de aspecto mate y una delicada textura con características antideslizante.

Matt porcelain tiles with a delicate texture and non-slip grip.

BUSH HAMMERED _BHMR

Suave relieve que confiere textura en superficies de aspecto mate y tacto único.

A matt surface with a gentle relief texture and unique feel.

ANTISLIP BUSH HAMMERED _ABHMR

Porcelánico antideslizante con rugosidad imperceptible al tacto.

Non-slip porcelain tiles, with a roughness imperceptible to the touch.



BLANCO White

Colección Collection	P.
Pasta Blanca White body	
COTTON	177
DONNA	183
FROZEN	193
ICE	217
LACCIO	223
PURE	243



CEMENTO Concrete

Colección Collection	P.
Porcelánico porcelain	
ALLEY 4D	49
DOWNTOWN 4D	73
DOWNTOWN FLOOR	77
GROUND	101
GROUND 4D	97
GRUNGE FLOOR	107
PLANET	149
SHARK	155
Pasta Blanca White body	
DONNA	183
DOWNTOWN WALL	185
GROUND WALL	205
GRUNGE WALL	209
SALINES	251



COLORES Colours

Colección Collection	P.
Porcelánico porcelain	
HOUSE OF VANITY	111
FS FIELD	287
FS HERITAGE	295
FS IVY	298
FS MARAIS	305
FS MUD	309
FS RAKU	319
FS ROCKSTAR	325
Gres Single fired	
FS ARLES	269
FS CLAY	277
FS ETNA	283
FS HERITAGE	295



COLORES Colours

Colección Collection	P.
Gres Single fired	
FS IVY	298
FS ROOTS	327
FS SEA	329
FS STAR	333
FS STAR LT	337
FS WABI SABI	347
FS YARD	351
Pasta Blanca White body	
PALETTE	239
FS IRON	297
FS LOFT	303
FS MUD	309
FS TRADITION	343
FS RAKU	319



MADERA Wood

Colección Collection	P.
Porcelánico porcelain	
ASPEN	57
ESSENCE	79
GRANIER FLOOR	91
GROVE	105
LENK	113
MUMBLE	137
UNIQUE	157
VERBIER	159
WHISTLER	165
Pasta Blanca White body	
GRANIER WALL	201
VERBIER WALL	255



METAL Metal

Colección Collection	P.
Porcelánico porcelain	
BRASS	59
Pasta Blanca White body	
MITTE	235



PIEDRA Stone

Colección Collection	P.
Porcelánico porcelain	
ALPINE 4D	53
CLUNY 4D	61
CLUNY FLOOR	69
GHENT 4D	81
GHENT FLOOR	87
LUCCA 4D	117
LUCCA FLOOR	123
MANHATTAN 4D	127
MANHATTAN FLOOR	133
MYSTIC 4D	141
NATURE FLOOR	145
SATYA	153
Pasta Blanca White body	
CLUNY WALL	171
DANUBIO	181
ERTA	191
GHENT WALL	197
LUCCA WALL	225
MANHATTAN WALL	229
NATURE WALL	237
VIBRATO	259



TEXTURA Texture

Colección Collection	P.
Gres Single fired	
FS ARLES	269
FS HERITAGE	295
FS SEA	329
FS STAR LT	337
Pasta Blanca White body	
FS MUD	309
FS RAKU	319
FS TRADITION	343



VINTAGE Fs

Colección Collection	P.
Porcelánico porcelain	
FS MARAIS	305
FS MELVIN	307
FS NORWICH	312
FS OFELIA	313
FS ROAD	321
FS ROCKSTAR	325
FS SEATTLE	330
FS SENA	331
FS VENDOME	344
FS VENECIA	345
FS WILD	349
Gres Single fired	
FS ALORA	268
FS ARLES	269
FS ARTISAN	271
FS AURORA	272
FS BLUME	273
FS BRETAGNE	274
FS CHESTER	275
FS CLAY	277
FS DAMERO	281
FS ETNA	283
FS FAENZA	285
FS FIELD	287
FS FOREST	291
FS HERITAGE	295
FS IVY	298
FS JAIPUR	299
FS MARRAKECH	306
FS MIRAMBEL	308
FS ORIGINAL	315
FS PORTO	317
FS ROOTS	327
FS SAJA	328
FS SEA	329
FS STAR	333
FS STAR LT	337
FS TEMPLE	341
FS TRADITION	343
FS WABI SABI	347
FS YARD	351
Pasta Blanca White body	
FS IRON	297
FS LOFT	303
FS MUD	309
FS TRADITION	343
FS RAKU	319



Clase 1_ UNE-ENV-12633

Colección Collection	Acabado Finished	P.
ALLEY 4D	Natural	49
ALPINE 4D	Shaped	53
ASPEN	Natural	57
BRASS	Lapado	59
CLUNY 4D	Shaped	61
CLUNY FLOOR	Soft	69
DOWNTOWN 4D	Shaped	73
ESSENCE	Natural	79
FS ALORA	Natural	268
FS ARTISAN	Natural	271
FS AURORA	Natural	272
FS BLUME	Natural	273
FS BRETAGNE	Natural	274
FS CHESTER	Natural	275
FS CLAY	Natural	277
FS DAMERO	Natural	281
FS ETNA	Natural	283
FS FAENZA	Natural	285
FS FOREST	Natural	291
FS IVY	Natural	298
FS JAIPUR	Natural	299
FS MARAIS	Natural	305
FS MARRAKECH	Natural	306
FS MELVIN	Natural	307
FS NORWICH	Natural	312
FS ORIGINAL	Natural	315
FS PORTO	Natural	317
FS ROOTS	Natural	327
FS SAJA	Natural	328
FS SEATTLE	Natural	330
FS SENA	Natural	331
FS STAR	Natural	333
FS STAR	Natural	333
FS TEMPLE	Natural	341
FS VENDOME	Natural	344
FS WABI SABI	Natural	347
FS YARD	Natural	351
GHENT 4D	Shaped	81
Grove	Natural	105
House of Vanity	Natural	111
LUCCA 4D	Shaped	117
LUCCA FLOOR	Soft	123
MANHATTAN 4D	Shaped	127
Mumble	Natural	137
Mumble	Natural	137
MYSTIC 4D	Natural	141
Planet	Soft	149
Satya	Natural	153
Shark	Lapado	155
Unique	Natural	157
Whistler	Natural	165

Clase 2_ UNE-ENV-12633

Colección Collection	Acabado Finished	P.
BRASS	Natural	59
DOWNTOWN FLOOR	Natural	77
DOWNTOWN FLOOR	Shaped	77
FS CHESTER	Natural	275
FS MIRAMBEL	Natural	308
FS OFELIA	Natural	313
FS ORIGINAL	Natural	315
FS STAR LT	Layer Tech	337
FS VENEZIA	Natural	345
GHENT FLOOR	Natural	87
GROUND	Lapado	101
GROUND	Soft	101
LUCCA FLOOR	Natural	123
MYSTIC 4D	Bush hammered	141
NATURE FLOOR	Soft	145
PLANET	Natural	149
SHARK	Natural	155
SHARK	Lapado	155

Clase 3_ UNE-ENV-12633

Colección Collection	Acabado Finished	P.
ALLEY 4D	Antislip bush hammered	49
ASPEN	Antislip	57
CLUNY 4D	Antislip	61
CLUNY FLOOR	All in one	69
DOWNTOWN FLOOR	Antislip	77
ESSENCE	Antislip	79
FS FIELD	Layer Tech_ All in one	287
FS ROAD	All in one	321
FS ROCKSTAR	All in one	325
FS WILD	All in one	349
GHENT 4D	Antislip	81
GHENT FLOOR	All in one	87
GRANIER FLOOR	All in one	91
GROUND	Antislip	101
GRUNGE FLOOR	All in one	107
GRUNGE WALL	Natural	209
LENK	All in one	113
LUCCA FLOOR	All in one	123
MANHATTAN 4D	Antislip	127
MANHATTAN FLOOR	All in one	133
MUMBLE	Antislip	137
MYSTIC 4D	Antislip bush hammered	141
NATURE FLOOR	Antislip	145
NATURE FLOOR	Antislip bush hammered	145
PLANET	Antislip	149
SATYA	Antislip	153
VERBIER	All in one	159
WHISTLER	Antislip	165

A_ DIN 51097

Colección Collection	Acabado Finished	P.
MYSTIC 4D	Natural	141

A+B_ DIN 51097

Colección Collection	Acabado Finished	P.
ASPEN	Antislip natural	57
BRASS	Natural	59
DOWNTOWN FLOOR	Natural	77
DOWNTOWN FLOOR	Shaped	77
ESSENCE	Antislip natural	79
FS ARTISAN	Natural	271
FS CHESTER	Natural	275
FS MIRAMBEL	Natural	308
FS OFELIA	Natural	313
FS ORIGINAL	Natural	315
FS VENEZIA	Natural	345
GHENT FLOOR	Natural	87
GROUND	Soft	101
LUCCA FLOOR	Natural	123
MYSTIC 4D	Bush hammered	141
NATURE FLOOR	Soft	145
PLANET	Natural	149
PLANET	Soft	149
SATYA	Natural	153
SHARK	Natural	155
WHISTLER	Antislip natural	165

A+B+C_ DIN 51097

Colección Collection	Acabado Finished	P.
ALLEY 4D	Antislip bush hammered	49
CLUNY 4D	Antislip	61
CLUNY FLOOR	All in one	69
DOWNTOWN FLOOR	Antislip	77
FS ROAD	All in one	321
FS ROCKSTAR	All in one	325
FS WILD	All in one	349
GHENT 4D	Antislip	81
GHENT FLOOR	All in one	87
GRANIER FLOOR	All in one	91
GRANIER FLOOR	All in one	91
GROUND	Antislip	101
GRUNGE FLOOR	All in one	107
GRUNGE WALL	Natural	209
LENK	All in one	113
LENK	All in one	113
MANHATTAN 4D	Antislip	127
MANHATTAN FLOOR	All in one	133
MUMBLE	Antislip	137
MYSTIC 4D	Antislip bush hammered	141
NATURE FLOOR	Antislip	145
NATURE FLOOR	Antislip bush hammered	145
PLANET	Antislip	149
SATYA	Antislip	153
VERBIER	All in one	159
VERBIER	All in one	159

R9_ DIN 51130

Colección Collection	Acabado Finished	P.
ALLEY 4D	Natural	49
ASPEN	Natural	57
BRASS	Lapado	59
ESSENCE	Natural	79
FS ALORA	Natural	268
FS ARTISAN	Natural	271
FS AURORA	Natural	272
FS BLUME	Natural	273
FS BRETAGNE	Natural	274
FS CHESTER	Natural	275
FS CLAY	Natural	277
FS DAMERO	Natural	281
FS ETNA	Natural	283
FS FAENZA	Natural	285
FS IVY	Natural	298
FS MARAIS	Natural	305
FS MARRAKECH	Natural	306
FS MELVIN	Natural	307
FS NORWICH	Natural	312
FS ORIGINAL	Natural	315
FS PORTO	Natural	317
FS ROOTS	Natural	327
FS SEATTLE	Natural	330
FS SENA	Natural	331
FS STAR	Natural	333
FS TEMPLE	Natural	341
FS VENDOME	Natural	344
FS WABI SABI	Natural	347
FS YARD	Natural	351
GROUND	Lapado	101
GROVE	Natural	105
HOUSE OF VANITY	Natural	111
MUMBLE	Natural	137
MYSTIC 4D	Natural	141
PLANET	Soft	149
SATYA	Natural	153
SHARK	Lapado	155
UNIQUE	Natural	157
WHISTLER	Natural	165

R10_ DIN 51130

Colección Collection	Acabado Finished	P.
BRASS	Natural	59
DOWNTOWN FLOOR	Natural	77
DOWNTOWN FLOOR	Shaped	77
FS ARTISAN	Natural	271
FS CHESTER	Natural	275
FS JAIPUR	Natural	299
FS MIRAMBEL	Natural	308
FS OFELIA	Natural	313
FS ORIGINAL	Natural	315
FS STAR LT	Layer Tech	337
GHENT FLOOR	Natural	87
GROUND	Soft	101
LUCCA FLOOR	Natural	123
LUCCA FLOOR	Natural	123
MYSTIC 4D	Bush hammered	141
NATURE FLOOR	Soft	145
PLANET	Natural	149
SHARK	Natural	155
SHARK	Natural	155

R11_ DIN 51130

Colección Collection	Acabado Finished	P.
ALLEY 4D	Antislip bush hammered	49
ASPEN	Antislip	57
CLUNY 4D	Antislip	61
CLUNY FLOOR	All in one	69
DOWNTOWN FLOOR	Antislip	77
ESSENCE	Antislip	79
FS FIELD	Layer Tech_All in one	287
FS ROAD	All in one	321
FS ROCKSTAR	All in one	325
FS VENECIA	Natural	345
FS WILD	All in one	349
GHENT 4D	Antislip	81
GHENT FLOOR	All in one	87
GRANIER FLOOR	All in one	91
GRUNGE WALL	Natural	209
LENK	All in one	113
LUCCA FLOOR	All in one	123
MANHATTAN 4D	Antislip	127
MANHATTAN FLOOR	All in one	133
MUMBLE	Antislip	137
NATURE FLOOR	Antislip	145
NATURE FLOOR	Antislip bush hammered	145
SATYA	Antislip	153
VERBIER	All in one	159
VERBIER	All in one	159
WHISTLER	Antislip	165

R12_ DIN 51130

Colección Collection	Acabado Finished	P.
GROUND	Antislip	101
MYSTIC 4D	Antislip bush hammered	141
PLANET	Antislip	149

PTV_ BS-7976-2

Colección Collection	Acabado Finished	P.
ALLEY 4D	Antislip bush hammered	49
ASPEN	Antislip	57
BRASS	Natural	59
CLUNY 4D	Antislip	61
CLUNY FLOOR	All in one	69
DOWNTOWN FLOOR	Natural	77
DOWNTOWN FLOOR	Shaped	77
DOWNTOWN FLOOR	Antislip	77
ESSENCE	Antislip	79
FS ALORA	Natural	268
FS ARTISAN	Natural	271
FS AURORA	Natural	272
FS CHESTER	Natural	275
FS CLAY	Natural	277
FS DAMERO	Natural	281
FS FIELD	Layer Tech_All in one	287
FS IVY	Natural	298
FS JAIPUR	Natural	299
FS MARAIS	Natural	305
FS MARRAKECH	Natural	306
FS MIRAMBEL	Natural	308
FS OFELIA	Natural	313
FS ORIGINAL	Natural	315
FS PORTO	Natural	317

PTV_ BS-7976-2

Colección Collection	Acabado Finished	P.
FS ROAD	All in one	321
FS ROCKSTAR	All in one	325
FS ROOTS	Natural	327
FS SENA	Natural	331
FS STAR	Natural	333
FS STAR LT	Layer Tech	337
FS TEMPLE	Natural	341
FS VENDOME	Natural	344
FS VENECIA	Natural	345
FS WABI SABI	Natural	347
FS WILD	All in one	349
FS YARD	Natural	351
GHENT 4D	Antislip	81
GHENT FLOOR	All in one	87
GHENT FLOOR	Natural	87
GRANIER FLOOR	All in one	91
GROUND	Soft	101
GROUND	Antislip	101
GRUNGE FLOOR	All in one	107
GRUNGE WALL	Natural	209
LENK	All in one	113
LUCCA FLOOR	All in one	123
LUCCA FLOOR	Natural	123
MANHATTAN 4D	Antislip	127
MANHATTAN FLOOR	All in one	133
MUMBLE	Antislip	137
MYSTIC 4D	Antislip bush hammered	141
MYSTIC 4D	Bush hammered	141
NATURE FLOOR	Antislip bush hammered	145
NATURE FLOOR	Soft	145
PLANET	Natural	149
PLANET	Soft	149
PLANET	Antislip	149
SATYA	Antislip	153
SATYA	Natural	153
SHARK	Natural	155
VERBIER	All in one	159
WHISTLER	Antislip	165

DCOF_

Colección Collection	Acabado Finished	P.
ALLEY 4D	Antislip bush hammered	49
ALLEY 4D	Natural	49
ALPINE 4D	Shaped	53
ASPEN	Natural	57
ASPEN	Antislip	57
BRASS	Natural	59
CLUNY 4D	Shaped	61
CLUNY 4D	Antislip	61
CLUNY FLOOR	All in one	69
CLUNY FLOOR	Soft	69
DOWNTOWN 4D	Shaped	73
DOWNTOWN FLOOR	Natural	77
DOWNTOWN FLOOR	Shaped	77
DOWNTOWN FLOOR	Antislip	77
ESSENCE	Antislip	79
ESSENCE	Natural	79
FS ALORA	Natural	268
FS ARTISAN	Natural	271
FS AURORA	Natural	272
FS BLUME	Natural	273
FS CHESTER	Natural	275
FS CLAY	Natural	277

DCOF_

Colección Collection	Acabado Finished	P.
FS DAMERO	Natural	281
FS ETNA	Natural	283
FS FIELD	Layer Tech_All in one	287
FS IVY	Natural	298
FS JAIPUR	Natural	299
FS MARAIS	Natural	305
FS MARRAKECH	Natural	306
FS MIRAMBEL	Natural	308
FS NORWICH	Natural	312
FS OFELIA	Natural	313
FS ORIGINAL	Natural	315
FS PORTO	Natural	317
FS ROAD	All in one	321
FS ROCKSTAR	All in one	325
FS ROOTS	Natural	327
FS SENA	Natural	331
FS STAR	Natural	333
FS STAR LT	Layer Tech	337
FS TEMPLE	Natural	341
FS VENDOME	Natural	344
FS VENECIA	Natural	345
FS WABI SABI	Natural	347
FS WILD	All in one	349
FS YARD	Natural	351
GHENT 4D	Shaped	81
GHENT 4D	Antislip	81
GHENT FLOOR	All in one	87
GHENT FLOOR	Natural	87
GRANIER FLOOR	All in one	91
GROUND	Lapado	101
GROUND	Soft	101
GROUND	Antislip	101
GRUNGE FLOOR	All in one	107
GRUNGE WALL	Natural	209
LENK	All in one	113
LUCCA 4D	Shaped	117
LUCCA FLOOR	All in one	123
LUCCA FLOOR	Natural	123
LUCCA FLOOR	Natural	123
LUCCA FLOOR	Natural	123
MANHATTAN 4D	Shaped	127
MANHATTAN 4D	Antislip	127
MANHATTAN FLOOR	All in one	133
MUMBLE	Antislip	137
MYSTIC 4D	Antislip bush hammered	141
MYSTIC 4D	Bush hammered	141
MYSTIC 4D	Natural	141
NATURE FLOOR	Antislip	145
NATURE FLOOR	Antislip bush hammered	145
NATURE FLOOR	Soft	145
PLANET	Natural	149
PLANET	Soft	149
PLANET	Antislip	149
SATYA	Antislip	153
VERBIER	All in one	159
VERBIER	All in one	159
WHISTLER	Antislip	165
WHISTLER	Natural	165

UPEC_ QB UPEC

Colección Collection	Color Colour	Acabado Finished	Formato Format	Valor Value	P.
GROUND	BONE	Lapatto	60x60x1	U4 P4+ E3 C2	101
GROUND	BONE	Soft	60x60x1	U4 P4+ E3 C2	101
GROUND	BONE	Antislip	60x60x1	U4 P4+ E3 C2	101
GROUND	GREY	Lapatto	60x60x1	U4 P4+ E3 C2	101
GROUND	GREY	Soft	60x60x1	U4 P4+ E3 C2	101
GROUND	GREY	Antislip	60x60x1	U4 P4+ E3 C2	101
GROUND	SILVER	Lapatto	60x60x1	U4 P4+ E3 C2	101
GROUND	SILVER	Soft	60x60x1	U4 P4+ E3 C2	101
GROUND	SILVER	Antislip	60x60x1	U4 P4+ E3 C2	101
GROUND	BONE	Lapatto	90x90x1	U4 P3 E3 C2	101
GROUND	BONE	Soft	90x90x1	U4 P3 E3 C2	101
GROUND	BONE	Antislip	90x90x1	U4 P3 E3 C2	101
GROUND	GREY	Lapatto	90x90x1	U4 P3 E3 C2	101
GROUND	GREY	Soft	90x90x1	U4 P3 E3 C2	101
GROUND	GREY	Antislip	90x90x1	U4 P3 E3 C2	101
GROUND	SILVER	Lapatto	90x90x1	U4 P3 E3 C2	101
GROUND	SILVER	Soft	90x90x1	U4 P3 E3 C2	101
GROUND	SILVER	Antislip	90x90x1	U4 P3 E3 C2	101
GRUNGE FLOOR	ANTHRACITE	All in one	60x120x1	U4P3E3C2	107
GRUNGE FLOOR	BEIGE	All in one	60x120x1	U4P3E3C2	107
GRUNGE FLOOR	GREY	All in one	60x120x1	U4P3E3C2	107
GRUNGE FLOOR	WHITE	All in one	60x120x1	U4P3E3C2	107
GRUNGE FLOOR	ANTHRACITE	All in one	60x60x1	U4P4+E3C2	107
GRUNGE FLOOR	BEIGE	All in one	60x60x1	U4P4+E3C2	107
GRUNGE FLOOR	GREY	All in one	60x60x1	U4P4+E3C2	107
GRUNGE FLOOR	WHITE	All in one	60x60x1	U4P4+E3C2	107
GRUNGE FLOOR	ANTHRACITE	All in one	90x90x1	U4P3E3C2	107
GRUNGE FLOOR	BEIGE	All in one	90x90x1	U4P3E3C2	107
GRUNGE FLOOR	GREY	All in one	90x90x1	U4P3E3C2	107
GRUNGE FLOOR	WHITE	All in one	90x90x1	U4P3E3C2	107
LENK	HONEY	All in one	19,5x121,5x1	U3 P2 E3 C2	113
LENK	WALNUT	All in one	19,5x121,5x1	U3 P2 E3 C2	113
LENK	ASH	All in one	19,5x121,5x1	U3 P2 E3 C2	113
LENK	SMOKE	All in one	19,5x121,5x1	U25 P2 E3 C2	113
LENK	TAUPE	All in one	19,5x121,5x1	U3 P2 E3 C2	113
LENK	WHITE	All in one	19,5x121,5x1	U3 P2 E3 C2	113
LENK	HONEY	All in one	24x151x1	U3 P2 E3 C2	113
LENK	WALNUT	All in one	24x151x1	U3 P2 E3 C2	113
LENK	ASH	All in one	24x151x1	U3 P2 E3 C2	113
LENK	SMOKE	All in one	24x151x1	U25 P2 E3 C2	113
LENK	TAUPE	All in one	24x151x1	U25 P2 E3 C2	113
LENK	WHITE	All in one	24x151x1	U3 P2 E3 C2	113
NATURE FLOOR	ANTHRACITE	Soft	60x120x1	U4P3E3C2	145
NATURE FLOOR	BEIGE	Soft	60x120x1	U4P3E3C2	145
NATURE FLOOR	GREY	Soft	60x120x1	U4P3E3C2	145
NATURE FLOOR	WHITE	Soft	60x120x1	U4P3E3C2	145
NATURE FLOOR	ANTHRACITE	Soft	60x60x1	U4P4+E3C2	145
NATURE FLOOR	BEIGE	Soft	60x60x1	U4P4+E3C2	145
NATURE FLOOR	GREY	Soft	60x60x1	U4P4+E3C2	145
NATURE FLOOR	WHITE	Soft	60x60x1	U4P4+E3C2	145
NATURE FLOOR	ANTHRACITE	Soft	90x90x1	U4P3E3C2	145
NATURE FLOOR	BEIGE	Soft	90x90x1	U4P3E3C2	145
NATURE FLOOR	GREY	Soft	90x90x1	U4P3E3C2	145
NATURE FLOOR	WHITE	Soft	90x90x1	U4P3E3C2	145
PLANET	ANTHRACITE	Soft	30x60x1	U4 P3 E3 C2	149
PLANET	BONE	Soft	30x60x1	U4 P3 E3 C2	149
PLANET	MUD	Soft	30x60x1	U4 P3 E3 C2	149
PLANET	SILVER	Soft	30x60x1	U4 P3 E3 C2	149
PLANET	WHITE	Soft	30x60x1	U4 P3 E3 C2	149
PLANET	ANTHRACITE	Natural	60x60x1	U4 P4 E3 C2	149
PLANET	BONE	Natural	60x60x1	U4 P4 E3 C2	149

UPEC_ QB UPEC

Colección Collection	Color Colour	Acabado Finished	Formato Format	Valor Value	P.
PLANET	ANTHRACITE	Soft	60x60x1	U4 P4 E3 C2	149
PLANET	ANTHRACITE	Antislip	60x60x1	U4 P4 E3 C2	149
PLANET	MUD	Natural	60x60x1	U4 P4 E3 C2	149
PLANET	SILVER	Natural	60x60x1	U4 P4 E3 C2	149
PLANET	BONE	Soft	60x60x1	U4 P4 E3 C2	149
PLANET	BONE	Antislip	60x60x1	U4 P4 E3 C2	149
PLANET	WHITE	Natural	60x60x1	U4 P4 E3 C2	149
PLANET	MUD	Soft	60x60x1	U4 P4 E3 C2	149
PLANET	MUD	Antislip	60x60x1	U4 P4 E3 C2	149
PLANET	SILVER	Soft	60x60x1	U4 P4 E3 C2	149
PLANET	SILVER	Antislip	60x60x1	U4 P4 E3 C2	149
PLANET	WHITE	Soft	60x60x1	U4 P4 E3 C2	149
PLANET	ANTHRACITE	Soft	90x90x1	U4 P3 E3 C2	149
PLANET	ANTHRACITE	Antislip	90x90x1	U4 P3 E3 C2	149
PLANET	BONE	Soft	90x90		



PAVIMENTO / FLOOR

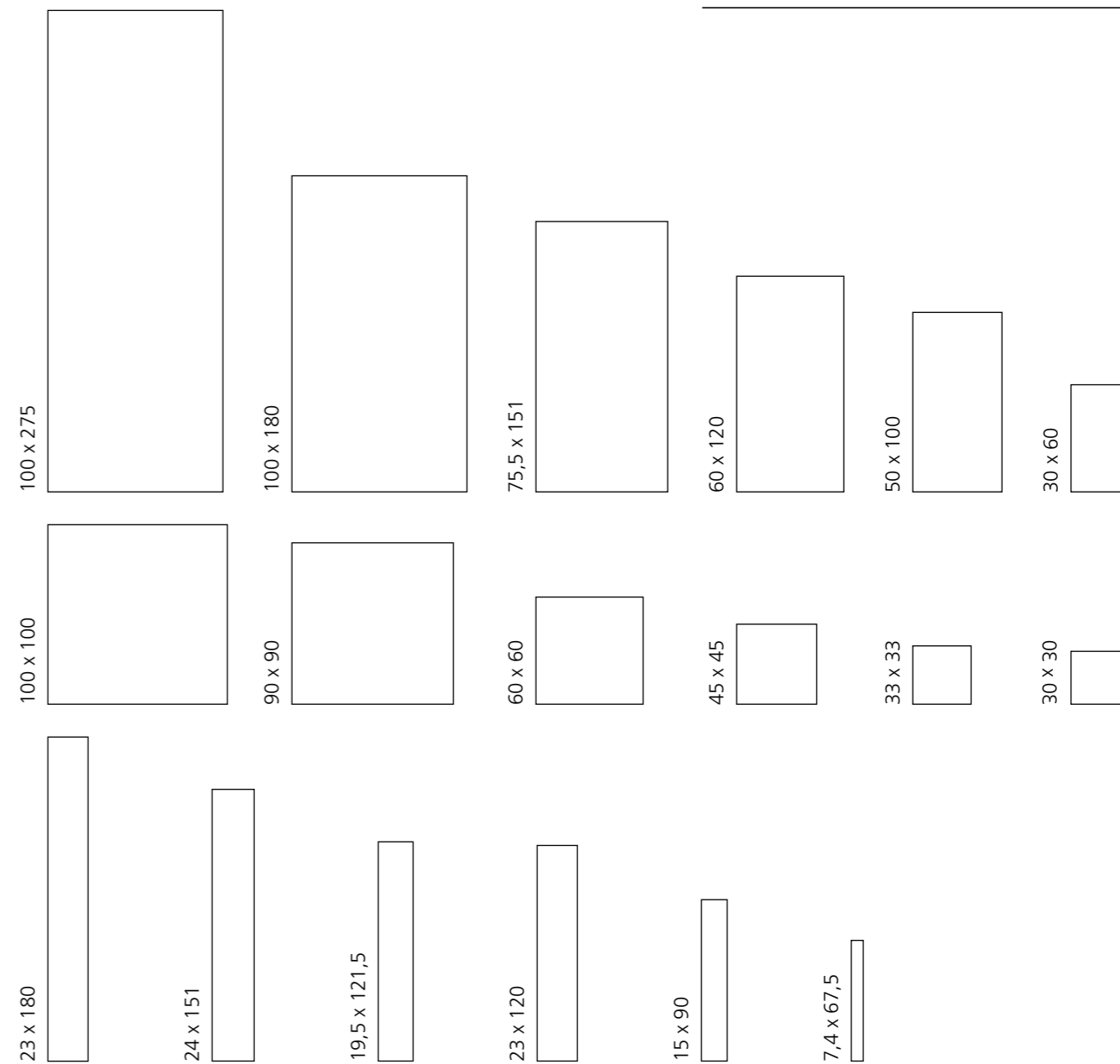

REVESTIMIENTO / WALL

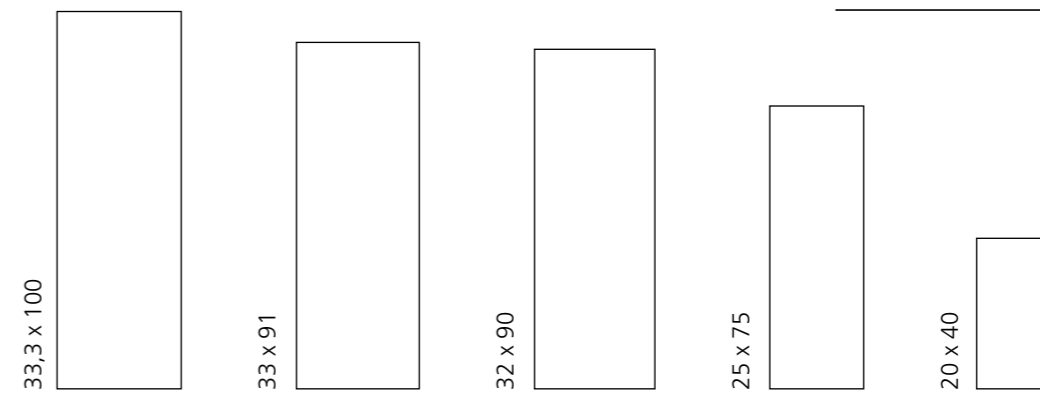

Tamaños SIZES

PAVIMENTO / FLOOR			
Formato / Format cm	Formato / Format inch	Colección / Collection	P.
100 x 100 x 0,6	39 3/8 x 39 3/8 x 1/4	DOWNTOWN 4D	73
100 x 100 x 0,6	39 3/8 x 39 3/8 x 1/4	GROUND 4D	97
100 x 100 x 0,6	39 3/8 x 39 3/8 x 1/4	LUCCA 4D	117
100 x 100 x 0,8	39 3/8 x 39 3/8 x 5/16	ALLEY 4D	49
100 x 100 x 0,8	39 3/8 x 39 3/8 x 5/16	ALPINE 4D	53
100 x 100 x 0,8	39 3/8 x 39 3/8 x 5/16	CLUNY 4D	61
100 x 100 x 0,8	39 3/8 x 39 3/8 x 5/16	GHENT 4D	81
100 x 100 x 0,8	39 3/8 x 39 3/8 x 5/16	MANHATTAN 4D	127
100 x 100 x 0,8	39 3/8 x 39 3/8 x 5/16	MYSTIC 4D	141
100 x 100 x 2	39 3/8 x 39 3/8 x 13/16	CLUNY 4D	61
100 x 100 x 2	39 3/8 x 39 3/8 x 13/16	GHENT 4D	81
100 x 100 x 2	39 3/8 x 39 3/8 x 13/16	MANHATTAN 4D	127
100 x 180 x 0,6	39 3/8 x 70 7/8 x 1/4	DOWNTOWN 4D	73
100 x 180 x 0,6	39 3/8 x 70 7/8 x 1/4	LUCCA 4D	117
100 x 180 x 0,8	39 3/8 x 70 7/8 x 5/16	ALPINE 4D	53
100 x 180 x 0,8	39 3/8 x 70 7/8 x 5/16	GHENT 4D	81
100 x 275 x 0,6	39 3/8 x 108 1/4 x 1/4	CLUNY 4D	61
100 x 275 x 0,6	39 3/8 x 108 1/4 x 1/4	GHENT 4D	81
100 x 275 x 0,6	39 3/8 x 108 1/4 x 1/4	LUCCA 4D	117
100 x 275 x 0,6	39 3/8 x 108 1/4 x 1/4	MANHATTAN 4D	127
15 x 90 x 1	5 7/8 x 35 7/16 x 3/8	MUMBLE	137
15 x 90 x 1	5 7/8 x 35 7/16 x 3/8	UNIQUE	157
19,5 x 121,5 x 1	7 11/16 x 47 13/16 x 3/8	ASPEN	57
19,5 x 121,5 x 1	7 11/16 x 47 13/16 x 3/8	ESSENCE	79
19,5 x 121,5 x 1	7 11/16 x 47 13/16 x 3/8	FS WILD	349
19,5 x 121,5 x 1	7 11/16 x 47 13/16 x 3/8	GRANIER FLOOR	91
19,5 x 121,5 x 1	7 11/16 x 47 13/16 x 3/8	GROVE	105
19,5 x 121,5 x 1	7 11/16 x 47 13/16 x 3/8	LENK	113
19,5 x 121,5 x 1	7 11/16 x 47 13/16 x 3/8	MUMBLE	137
19,5 x 121,5 x 1	7 11/16 x 47 13/16 x 3/8	UNIQUE	157
19,5 x 121,5 x 1	7 11/16 x 47 13/16 x 3/8	VERBIER	159
19,5 x 19,5 x 1	7 11/16 x 7 11/16 x 3/8	GROVE	105
23 x 180 x 1,1	9 1/16 x 70 7/8 x 7/16	MUMBLE	137
24 x 151 x 1	9 7/16 x 59 7/16 x 3/8	ESSENCE	79
24 x 151 x 1	9 7/16 x 59 7/16 x 3/8	GRANIER FLOOR	91
24 x 151 x 1	9 7/16 x 59 7/16 x 3/8	LENK	113
24 x 151 x 1	9 7/16 x 59 7/16 x 3/8	VERBIER	159
24 x 151 x 1	9 7/16 x 59 7/16 x 3/8	WHISTLER	165
29 x 90 x 1	11 7/16 x 35 7/16 x 3/8	GROUND	101
29 x 90 x 1	11 7/16 x 35 7/16 x 3/8	NATURE FLOOR	145
29 x 90 x 1	11 7/16 x 35 7/16 x 3/8	PLANET	149
30 x 30 x 0,8	11 13/16 x 11 13/16 x 5/16	FS SEATTLE	330
30 x 60 x 1	11 13/16 x 23 5/8 x 3/8	PLANET	149
33 x 33 x 0,9	13 x 13 x 3/8	HOUSE OF VANITY	111
33 x 33 x 0,95	13 x 13 x 3/8	FS ARLES	269
33 x 33 x 0,95	13 x 13 x 3/8	FS ARTISAN	271
33 x 33 x 0,95	13 x 13 x 3/8	FS CHESTER	275
33 x 33 x 0,95	13 x 13 x 3/8	FS ETNA	283
33 x 33 x 0,95	13 x 13 x 3/8	FS FAENZA	285
33 x 33 x 0,95	13 x 13 x 3/8	FS MIRAMBEL	308
33 x 33 x 0,95	13 x 13 x 3/8	FS NORWICH	312
33 x 33 x 0,95	13 x 13 x 3/8	FS SAJA	328

PAVIMENTO / FLOOR			
Formato / Format cm	Formato / Format inch	Colección / Collection	P.
33 x 33 x 0,95	13 x 13 x 3/8	FS SEA	329
33 x 33 x 0,95	13 x 13 x 3/8	FS WABI SABI	347
45,2 x 45,2 x 0,87	17 13/16 x 17 13/16 x 5/16	FS FIELD	287
45,2 x 45,2 x 0,87	17 13/16 x 17 13/16 x 5/16	FS MARAIS	305
45,2 x 45,2 x 0,87	17 13/16 x 17 13/16 x 5/16	FS OFELIA	313
45,2 x 45,2 x 0,87	17 13/16 x 17 13/16 x 5/16	FS ROCKSTAR	325
45,2 x 45,2 x 0,87	17 13/16 x 17 13/16 x 5/16	FS SENA	331
45,2 x 45,2 x 0,87	17 13/16 x 17 13/16 x 5/16	FS VENDOME	344
45,2 x 45,2 x 0,87	17 13/16 x 17 13/16 x 5/16	FS VENEZIA	345
45 x 45 x 0,95	17 11/16 x 17 11/16 x 3/8	FS ALORA	268
45 x 45 x 0,95	17 11/16 x 17 11/16 x 3/8	FS AURORA	272
45 x 45 x 0,95	17 11/16 x 17 11/16 x 3/8	FS BLUME	273
45 x 45 x 0,95	17 11/16 x 17 11/16 x 3/8	FS BRETAGNE	274
45 x 45 x 0,95	17 11/16 x 17 11/16 x 3/8	FS CHESTER	275
45 x 45 x 0,95	17 11/16 x 17 11/16 x 3/8	FS CLAY	277
45 x 45 x 0,95	17 11/16 x 17 11/16 x 3/8	FS DAMERO	281
45 x 45 x 0,95	17 11/16 x 17 11/16 x 3/8	FS FOREST	291
45 x 45 x 0,95	17 11/16 x 17 11/16 x 3/8	FS HERITAGE	295
45 x 45 x 0,95	17 11/16 x 17 11/16 x 3/8	FS IVY	298
45 x 45 x 0,95	17 11/16 x 17 11/16 x 3/8	FS JAIPUR	299
45 x 45 x 0,95	17 11/16 x 17 11/16 x 3/8	FS MARRAKECH	306
45 x 45 x 0,95	17 11/16 x 17 11/16 x 3/8	FS ORIGINAL	315
45 x 45 x 0,95	17 11/16 x 17 11/16 x 3/8	FS PORTO	317
45 x 45 x 0,95	17 11/16 x 17 11/16 x 3/8	FS ROOTS	327
45 x 45 x 0,95	17 11/16 x 17 11/16 x 3/8	FS STAR	333
45 x 45 x 0,95	17 11/16 x 17 11/16 x 3/8	FS STAR LT	337
45 x 45 x 0,95	17 11/16 x 17 11/16 x 3/8	FS TEMPLE	341
45 x 45 x 0,95	17 11/16 x 17 11/16 x 3/8	FS WABI SABI	347
45 x 45 x 0,95	17 11/16 x 17 11/16 x 3/8	FS YARD	351
50 x 100 x 2	19 11/16 x 39 3/8 x 13/16	CLUNY 4D	61
50 x 100 x 2	19 11/16 x 39 3/8 x 13/16	GHENT 4D	81
50 x 100 x 2	19 11/16 x 39 3/8 x 13/16	MANHATTAN 4D	127
60 x 120 x 1	23 5/8 x 47 1/4 x 3/8	BRASS	59
60 x 120 x 1	23 5/8 x 47 1/4 x 3/8	CLUNY FLOOR	69
60 x 120 x 1	23 5/8 x 47 1/4 x 3/8	DOWNTOWN FLOOR	77
60 x 120 x 1	23 5/8 x 47 1/4 x 3/8	GHENT FLOOR	87
60 x 120 x 1	23 5/8 x 47 1/4 x 3/8	GRUNGE FLOOR	107
60 x 120 x 1	23 5/8 x 47 1/4 x 3/8	LUCCA FLOOR	123
60 x 120 x 1	23 5/8 x 47 1/4 x 3/8	MANHATTAN FLOOR	133
60 x 120 x 1	23 5/8 x 47 1/4 x 3/8	NATURE FLOOR	145
60 x 120 x 1	23 5/8 x 47 1/4 x 3/8	PLANET	149
60 x 60 x 1	23 5/8 x 23 5/8 x 3/8	DOWNTOWN FLOOR	77
60 x 60 x 1	23 5/8 x 23 5/8 x 3/8	FS VENEZIA	345
60 x 60 x 1	23 5/8 x 23 5/8 x 3/8	GHENT FLOOR	87
60 x 60 x 1	23 5/8 x 23 5/8 x 3/8	GROUND	101
60 x 60 x 1	23 5/8 x 23 5/8 x 3/8	GRUNGE FLOOR	107
60 x 60 x 1	23 5/8 x 23 5/8 x 3/8	LUCCA FLOOR	123
60 x 60 x 1	23 5/8 x 23 5/8 x 3/8	MANHATTAN FLOOR	133
60 x 60 x 1	23 5/8 x 23 5/8 x 3/8	NATURE FLOOR	145
60 x 60 x 1	23 5/8 x 23 5/8 x 3/8	PLANET	149
60 x 60 x 1	23 5/8 x 23 5/8 x 3/8	SHARK	155
7,3 x 45 x 1,05	2 7/8 x 17 11/16 x 7/16	FS FOREST	291

PAVIMENTO / FLOOR			
Formato / Format cm	Formato / Format inch	Colección / Collection	P.
7,4 x 67,5 x 1,05	2 15/16 x 26 9/16 x 7/16	FS MELVIN	307
75,5 x 151 x 1	29 3/4 x 59 7/16 x 7/16	GRUNGE FLOOR	107
75,5 x 151 x 1	29 3/4 x 59 7/16 x 3/8	GRUNGE FLOOR	107
75,5 x 151 x 1	29 3/4 x 59 7/16 x 3/8	NATURE FLOOR	145
75,5 x 151 x 1	29 3/4 x 59 7/16 x 3/8	PLANET	149
90 x 90 x 1	35 7/16 x 35 7/16 x 3/8	CLUNY FLOOR	69
90 x 90 x 1	35 7/16 x 35 7/16 x 3/8	DOWNTOWN FLOOR	77
90 x 90 x 1	35 7/16 x 35 7/16 x 3/8	FS ROAD	321
90 x 90 x 1	35 7/16 x 35 7/16 x 3/8	GHENT FLOOR	87
90 x 90 x 1	35 7/16 x 35 7/16 x 3/8	GROUND	101
90 x 90 x 1	35 7/16 x 35 7/16 x 3/8	GRUNGE FLOOR	107
90 x 90 x 1	35 7/16 x 35 7/16 x 3/8	LUCCA FLOOR	123
90 x 90 x 1	35 7/16 x 35 7/16 x 3/8	MANHATTAN FLOOR	133
90 x 90 x 1	35 7/16 x 35 7/16 x 3/8	NATURE FLOOR	145
90 x 90 x 1	35 7/16 x 35 7/16 x 3/8	PLANET	149
90 x 90 x 1	35 7/16 x 35 7/16 x 3/8	SATYA	153
90 x 90 x 1	35 7/16 x 35 7/16 x 3/8	SHARK	155

REVESTIMIENTO / WALL			
Formato / Format cm	Formato / Format inch	Colección / Collection	P.
20 x 40 x 1,03	7 7/8 x 15 3/4 x 3/8	FS IRON	297
20 x 40 x 1,03	7 7/8 x 15 3/4 x 3/8	FS LOFT	303
20 x 40 x 1,03	7 7/8 x 15 3/4 x 3/8	FS MUD	309
20 x 40 x 1,03	7 7/8 x 15 3/4 x 3/8	FS RAKU	319
20 x 40 x 1,03	7 7/8 x 15 3/4 x 3/8	FS TRADITION	343
25 x 75 x 1,05	9 13/16 x 29 1/2 x 7/16	ERTA	191
25 x 75 x 1,05	9 13/16 x 29 1/2 x 7/16	GRUNGE WALL	209
25 x 75 x 1,05	9 13/16 x 29 1/2 x 7/16	MITTE	235
25 x 75 x 1,05	9 13/16 x 29 1/2 x 7/16	PURE	243
25 x 75 x 1,05	9 13/16 x 29 1/2 x 7/16	VIBRATO	259
32 x 90 x 1,05	12 5/8 x 35 7/16 x 7/16	DANUBIO	181
32 x 90 x 1,05	12 5/8 x 35 7/16 x 7/16	FROZEN	193
32 x 90 x 1,05	12 5/8 x 35 7/16 x 7/16	GRUNGE WALL	209
32 x 90 x 1,05	12 5/8 x 35 7/16 x 7/16	LACCIO	223
32 x 90 x 1,05	12 5/8 x 35 7/16 x 7/16	NATURE WALL	237
32 x 90 x 1,05	12 5/8 x 35 7/16 x 7/16	PALETTE	239
32 x 90 x 1,05	12 5/8 x 35 7/16 x 7/16	PURE	243
33 x 91 x 1,05	13 x 35 13/16 x 7/16	DANUBIO	181
33 x 91 x 1,05	13 x 35 13/16 x 7/16	FROZEN	193
33 x 91 x 1,05	13 x 35 13/16 x 7/16	PURE	243
33,3 x 100 x 0,75	13 1/8 x 39 3/8 x 1/4	CLUNY WALL	171
33,3 x 100 x 0,75	13 1/8 x 39 3/8 x 1/4	COTTON	177
33,3 x 100 x 0,75	13 1/8 x 39 3/8 x 1/4	DONNA	183
33,3 x 100 x 0,75	13 1/8 x 39 3/8 x 5/16	DOWNTOWN WALL	185
33,3 x 100 x 0,75	13 1/8 x 39 3/8 x 5/16	ERTA	191
33,3 x 100 x 0,75	13 1/8 x 39 3/8 x 5/16	FROZEN	193
33,3 x 100 x 0,75	13 1/8 x 39 3/8 x 5/16	GHENT WALL	197
33,3 x 100 x 0,75	13 1/8 x 39 3/8 x 5/16	GROUND WALL	205
33,3 x 100 x 0,75	13 1/8 x 39 3/8 x 5/16	ICE	217
33,3 x 100 x 0,75	13 1/8 x 39 3/8 x 5/16	LUCCA WALL	225
33,3 x 100 x 0,75	13 1/8 x 39 3/8 x 5/16	MANHATTAN WALL	229
33,3 x 100 x 0,75	13 1/8 x 39 3/8 x 5/16	PURE	243
33,3 x 100 x 0,75	13 1/8 x 39 3/8 x 5/16	SALINES	251
33,3 x 100 x 0,86	13 1/8 x 39 3/8 x 5/16	CLUNY WALL	171
33,3 x 100 x 0,86	13 1/8 x 39 3/8 x 5/16	COTTON	177
33,3 x 100 x 0,86	13 1/8 x 39 3/8 x 5/16	DONNA	183
33,3 x 100 x 0,86	13 1/8 x 39 3/8 x 5/16	DOWNTOWN WALL	185
33,3 x 100 x 0,86	13 1/8 x 39 3/8 x 5/16	GHENT WALL	197
33,3 x 100 x 0,86	13 1/8 x 39 3/8 x 5/16	GRANIER WALL	201
33,3 x 100 x 0,86	13 1/8 x 39 3/8 x 5/16	GROUND WALL	205
33,3 x 100 x 0,86	13 1/8 x 39 3/8 x 5/16	ICE	217
33,3 x 100 x 0,86	13 1/8 x 39 3/8 x 5/16	LUCCA WALL	225
33,3 x 100 x 0,86	13 1/8 x 39 3/8 x 5/16	MANHATTAN WALL	229
33,3 x 100 x 0,86	13 1/8 x 39 3/8 x 5/16	SALINES	251
33,3 x 100 x 0,86	13 1/8 x 39 3/8 x 5/16	VERBIER WALL	255



Artículo / Article	Serie	Ref.	Tarifa / Price list	Formato / Size	Pzs. caja / Pcs. box	Peso caja / Weight box	P.
ALEX-G	MITTE	20173	BN-20	25x75x1,05	7	24,7	235
ALEX-W	MITTE	20174	BN-20	25x75x1,05	7	24,7	235
ALLEY ANTHRACITE/100x100/BHMR/R	ALLEY 4D	23405	BN-99	100x100x0,8	2	39,3	49
ALLEY ANTHRACITE/100x100/R	ALLEY 4D	23400	BN-94	100x100x0,8	2	39,3	49
ALLEY BONE/100x100/BHMR/R	ALLEY 4D	23403	BN-99	100x100x0,8	2	39,3	49
ALLEY BONE/100x100/R	ALLEY 4D	23398	BN-94	100x100x0,8	2	39,3	49
ALLEY GREY/100x100/BHMR/R	ALLEY 4D	23402	BN-99	100x100x0,8	2	39,3	49
ALLEY GREY/100x100/R	ALLEY 4D	23397	BN-94	100x100x0,8	2	39,3	49
ALLEY WHITE/100x100/BHMR/R	ALLEY 4D	23401	BN-112	100x100x0,8	2	39,3	49
ALLEY WHITE/100x100/R	ALLEY 4D	23396	BN-110	100x100x0,8	2	39,3	49
ALPINE ANTH DECOR SP/100x180/R	ALPINE 4D	29035	BN-139	100x180x0,8	2	70,9	53
ALPINE ANTH SP/100x100/R	ALPINE 4D	28948	BN-135	100x100x0,8	2	39,3	53
ALPINE ANTH SP/100x180/R	ALPINE 4D	28519	BN-137	100x180x0,8	2	70,9	53
ALPINE BEIGE DECOR SP/100x180/R	ALPINE 4D	29033	BN-139	100x180x0,8	2	70,9	53
ALPINE BEIGE SP/100x100/R	ALPINE 4D	28946	BN-135	100x100x0,8	2	39,3	53
ALPINE BEIGE SP/100x180/R	ALPINE 4D	28520	BN-137	100x180x0,8	2	70,9	53
ALPINE GREY DECOR SP/100x180/R	ALPINE 4D	29034	BN-139	100x180x0,8	2	70,9	53
ALPINE GREY SP/100x100/R	ALPINE 4D	28947	BN-135	100x100x0,8	2	39,3	53
ALPINE GREY SP/100x180/R	ALPINE 4D	28522	BN-137	100x180x0,8	2	70,9	53
ALPINE WHITE DECOR SP/100x180/R	ALPINE 4D	29036	BN-140	100x180x0,8	2	70,9	53
ALPINE WHITE SP/100x100/R	ALPINE 4D	28945	BN-136	100x100x0,8	2	39,3	53
ALPINE WHITE SP/100x180/R	ALPINE 4D	28521	BN-138	100x180x0,8	2	70,9	53
ARR.1 PLANET ANTH SF/34,4x14,6	PLANET	22490	P-35	34,6x15x1	10	11	149
ARR.1 PLANET BONE SF/34,4x14,6	PLANET	22491	P-35	34,6x15x1	10	11	149
ARR.1 PLANET MUD SF/34,4x14,6	PLANET	22493	P-35	34,6x15x1	10	11	149
ARR.1 PLANET SILVER SF/34,4x14,6	PLANET	22494	P-35	34,6x15x1	10	11	149
ARR.1 PLANET WHITE SF/34,4x14,6	PLANET	25794	P-35	34,6x15x1	10	11	149
ARR.2 PLANET ANTH SF/34,4x14,6	PLANET	22495	P-35	34,6x15x1	10	11	149
ARR.2 PLANET BONE SF/34,4x14,6	PLANET	22496	P-35	34,6x15x1	10	11	149
ARR.2 PLANET MUD SF/34,4x14,6	PLANET	22498	P-35	34,6x15x1	10	11	149
ARR.2 PLANET SILVER SF/34,4x14,6	PLANET	22499	P-35	34,6x15x1	10	11	149
ARR.2 PLANET WHITE SF/34,4x14,6	PLANET	25796	P-35	34,6x15x1	10	11	149
ASPEN ASH NT/19,5x121,5/R	ASPEN	24958	BN-60	19,5x121,5x1	4	22,2	57
ASPEN CAMEL NT/19,5x121,5/R	ASPEN	24957	BN-60	19,5x121,5x1	4	22,2	57
ASPEN CAMEL/19,5x121,5/A/R	ASPEN	24961	BN-95	19,5x121,5x1	4	22,2	57
ASPEN SAND NT/19,5x121,5/R	ASPEN	24959	BN-60	19,5x121,5x1	4	22,2	57
ASPEN SMOKE NT/19,5x121,5/R	ASPEN	24960	BN-60	19,5x121,5x1	4	22,2	57
ASPEN SMOKE/19,5x121,5/A/R	ASPEN	24962	BN-95	19,5x121,5x1	4	22,2	57
BARCELOS/15x90/R	MUMBLE	25369	BN-76	15x90x1	7	21,7	137
BRASS CLOUD/60x120/L/R	BRASS	25594	BN-86	60x120x1	2	33,2	59
BRASS CLOUD/60x120/R	BRASS	25597	BN-72	60x120x1	2	33,2	59
BRASS NIGHT/60x120/L/R	BRASS	25595	BN-86	60x120x1	2	33,2	59
BRASS NIGHT/60x120/R	BRASS	25598	BN-72	60x120x1	2	33,2	59
BRASS OXIDE/60x120/L/R	BRASS	25596	BN-86	60x120x1	2	33,2	59
BRASS OXIDE/60x120/R	BRASS	25599	BN-72	60x120x1	2	33,2	59
C. FS FAENZA-A	FS FAENZA	13714	P-12	11x33x0,95	24	17,1	285
C. FS FAENZA-N	FS FAENZA	13715	P-12	11x33x0,95	24	17,1	285
C. FS MANISES-B	FS FAENZA	13716	P-12	11x33x0,95	24	17,1	285
C.HV-12	HOUSE OF VANITY	14683	P-12	11x33x0,9	24	15,7	111
C.HV-34	HOUSE OF VANITY	14684	P-12	11x33x0,9	24	15,8	111
CLUNY BEIGE AS/60x120/C/R	CLUNY FLOOR	36356	BN-116	60x120x1	2	33,2	69
CLUNY BEIGE AS/90x90/C/R	CLUNY FLOOR	36354	BN-90	90x90x1	2	38	69
CLUNY BEIGE SF/90x90/R	CLUNY FLOOR	36360	BN-48	90x90x1	2	38	69

Artículo / Article	Serie	Ref.	Tarifa / Price list	Formato / Size	Pzs. caja / Pcs. box	Peso caja / Weight box	P.
CLUNY BEIGE SP/100x100/R	CLUNY 4D	36337	BN-135	100x100x0,8	2	39,3	61
CLUNY BEIGE SP/100x275/R	CLUNY 4D	36282	BN-141	100x275x0,6	1	38,5	61
CLUNY BEIGE/100x100/A/R	CLUNY 4D	36341	BN-144	100x100x0,8	2	39,3	61
CLUNY BEIGE/100x100x2/A/R	CLUNY 4D	36348	BN-145	100x100x2	1	49,2	61
CLUNY BEIGE/50x100x2/A/R	CLUNY 4D	36902	BN-147	50x100x2	1	24,7	61
CLUNY SAND AS/60x120/C/R	CLUNY FLOOR	36358	BN-116	60x120x1	2	33,2	69
CLUNY SAND AS/90x90/C/R	CLUNY FLOOR	36353	BN-90	90x90x1	2	38	69
CLUNY SAND DECOR/33,3x100/R	CLUNY WALL	36369	BN-66	33,3x100x0,86	5	22,5	171
CLUNY SAND SF/90x90/R	CLUNY FLOOR	36362	BN-48	90x90x1	2	38	69
CLUNY SAND SP/100x100/R	CLUNY 4D	36338	BN-135	100x100x0,8	2	39,3	61
CLUNY SAND SP/100x275/R	CLUNY 4D	36281	BN-141	100x275x0,6	1	38,5	61
CLUNY SAND TEXTURED/33,3x100/R	CLUNY WALL	36368	BN-65	33,3x100x0,75	6	24,9	171
CLUNY SAND/100x100/A/R	CLUNY 4D	36343	BN-144	100x100x0,8	2	39,3	61
CLUNY SAND/100x100x2/A/R	CLUNY 4D	36350	BN-145	100x100x2	1	49,2	61
CLUNY SAND/33,3x100/R	CLUNY WALL	36365	BN-65	33,3x100x0,75	6	24,9	171
CLUNY SAND/50x100x2/A/R	CLUNY 4D	36903	BN-147	50x100x2	1	24,7	61
CLUNY SILVER AS/60x120/C/R	CLUNY FLOOR	36357	BN-116	60x120x1	2	33,2	69
CLUNY SILVER AS/90x90/C/R	CLUNY FLOOR	36352	BN-90	90x90x1	2	38	69
CLUNY SILVER DECOR/33,3x100/R	CLUNY WALL	36371	BN-66	33,3x100x0,86	5	22,5	171
CLUNY SILVER SF/90x90/R	CLUNY FLOOR	36361	BN-48	90x90x1	2	38	69
CLUNY SILVER SP/100x100/R	CLUNY 4D	36339	BN-135	100x100x0,8	2	39,3	61
CLUNY SILVER SP/100x275/R	CLUNY 4D	36283	BN-141	100x275x0,6	1	38,5	61
CLUNY SILVER TEXTURED/33,3x100/R	CLUNY WALL	36370	BN-65	33,3x100x0,75	6	24,9	171
CLUNY SILVER/100x100/A/R	CLUNY 4D	36342	BN-144	100x100x0,8	2	39,3	61
CLUNY SILVER/100x100x2/A/R	CLUNY 4D	36349	BN-145	100x100x2	1	49,2	61
CLUNY SILVER/33,3x100/R	CLUNY WALL	36366	BN-65	33,3x100x0,75	6	24,9	171
CLUNY SILVER/50x100x2/A/R	CLUNY 4D	36904	BN-147	50x100x2	1	24,7	61
CLUNY WHITE AS/60x120/C/R	CLUNY FLOOR	36355	BN-116	60x120x1	2	33,2	69
CLUNY WHITE AS/90x90/C/R	CLUNY FLOOR	36351	BN-90	90x90x1	2	38	69
CLUNY WHITE DECOR/33,3x100/R	CLUNY WALL	36367	BN-66	33,3x100x0,86	5	22,5	171
CLUNY WHITE SF/90x90/R	CLUNY FLOOR	36359	BN-48	90x90x1	2	38	69
CLUNY WHITE SP/100x100/R	CLUNY 4D	36336	BN-136	100x100x0,8	2	39,3	61
CLUNY WHITE SP/100x275/R	CLUNY 4D	36280	BN-142	100x275x0,6	1	38,5	61
CLUNY WHITE TEXTURED/33,3x100/R	CLUNY WALL	36364	BN-65	33,3x100x0,75	6	24,9	171
CLUNY WHITE/100x100/A/R	CLUNY 4D	36340	BN-143	100x100x0,8	2	39,3	61
CLUNY WHITE/100x100x2/A/R	CLUNY 4D	36347	BN-145	100x100x2	1	49,2	61
CLUNY WHITE/33,3x100/R	CLUNY WALL	36363	BN-65	33,3x100x0,75	6	24,9	171
CLUNY WHITE/50x100x2/A/R	CLUNY 4D	36905	BN-147	50x100x2	1	24,7	61
COR.FS MIRABEL-A	FS MIRABEL	27093	P-23	5x11x1	24	2,2	308
COR.FS MIRABEL-M	FS MIRABEL	27094	P-23	5x11x1	24	2,2	308
COTTON DIAMOND/33,3x100/R	COTTON	30854	BN-5	33,3x100x0,86	5	22,5	177
COTTON FOLD/33,3x100/R	COTTON	30855	BN-5	33,3x100x0,86	5	22,5	177
COTTON WAVES/33,3x100/R	COTTON	30856	BN-5	33,3x100x0,86	5	22,5	177
COTTON/33,3x100/R	COTTON	30852	BN-4	33,3x100x0,75	6	24,9	177
D.ALLEY ANTHRA BRICK/29,8x29,2	ALLEY 4D	23493	P-50	29,8x29,2x0,8	8	12,1	49
D.ALLEY ANTHRA MOSAIC/25x25	ALLEY 4D	23481	P-39	25x25x0,8	8	7,7	49
D.ALLEY ANTHRA MOSAIC/25x25/BHMR	ALLEY 4D	23488	P-39	25x25x0,8	8	7,7	49
D.ALLEY BONE BRICK/29,8x29,2	ALLEY 4D	23494	P-50	29,8x29,2x0,8	8	12,1	49
D.ALLEY BONE MOSAIC/25x25	ALLEY 4D	23482	P-39	25x25x0,8	8	7,7	49
D.ALLEY BONE MOSAIC/25x25/BHMR	ALLEY 4D	23487	P-39	25x25x0,8	8	7,7	49
D.ALLEY GREY BRICK/29,8x29,2	ALLEY 4D	23495	P-50	29,8x29,2x0,8	8	12,2	49
D.ALLEY GREY MOSAIC/25x25	ALLEY 4D	23483	P-39	25x25x0,8	8	7,7	49
D.ALLEY GREY MOSAIC/25x25/BHMR	ALLEY 4D	23489	P-39	25x25x0,8	8	7,7	49

Artículo / Article	Serie	Ref.	Tarifa / Price list	Formato / Size	Pzs. caja / Pcs. box	Peso caja / Weight box	P.
D.ALLEY MUD BRICK/29,8x29,2	ALLEY 4D	23496	P-50	29,8x29,2x0,8	8	12,2	49
D.ALLEY MUD MOSAIC/25x25	ALLEY 4D	23484	P-39	25x25x0,8	8	7,7	49
D.ALLEY MUD MOSAIC/25x25/BHMR	ALLEY 4D	23490	P-39	25x25x0,8	8	7,7	49
D.ALLEY WHITE BRICK/29,8x29,2	ALLEY 4D	23497	P-50	29,8x29,2x0,8	8	12,2	49
D.ALLEY WHITE MOSAIC/25x25	ALLEY 4D	23485	P-39	25x25x0,8	8	7,7	49
D.ALLEY WHITE MOSAIC/25x25/BHMR	ALLEY 4D	23491	P-39	25x25x0,8	8	7,7	49
D.BRAZEN CLOUD/5	BRASS	21331	P-45	30x30x1	8	15,4	59
D.BRAZEN NIGHT/5	BRASS	21332	P-45	30x30x1	8	15,9	59
D.BRAZEN OXIDE/5	BRASS	21333	P-45	30x30x1	8	15,9	59
D.DONNA LEAVES/100/R	DONNA	27776	P-77	33,3x100x0,75	6	26,6	183
D.GHENT BEIGE MOSAIC/12T/AS/30x30/C/R	GHENT FLOOR	32103	P-36	30x30x1	8	15,9	87
D.GHENT BEIGE MOSAIC/16T/AS/30x30/C/R	GHENT FLOOR	32099	P-36	30x30x1	8	15,9	87
D.GHENT GREY MOSAIC/12T/AS/30x30/C/R	GHENT FLOOR	32104	P-36	30x30x1	8	15,9	87
D.GHENT GREY MOSAIC/16T/AS/30x30/C/R	GHENT FLOOR	32100	P-36	30x30x1	8	15,9	87
D.GHENT SILVER MOSAIC/12T/AS/30x30/C/R	GHENT FLOOR	32105	P-36	30x30x1	8	15,9	87
D.GHENT SILVER MOSAIC/16T/AS/30x30/C/R	GHENT FLOOR	32101	P-36	30x30x1	8	15,9	87
D.GHENT WHITE MOSAIC/12T/AS/30x30/C/R	GHENT FLOOR	32106	P-36	30x30x1	8	15,9	87
D.GHENT WHITE MOSAIC/16T/AS/30x30/C/R	GHENT FLOOR	32102	P-36	30x30x1	8	15,9	87
D.GROUND BONE MOSAIC SF/30x30/C/R	GROUND	23435	P-37	30x30x1	8	15,9	101
D.GROUND BONE SPAC SF/30x30/C/R	GROUND	23505	P-58	30x30x1	8	15,6	101
D.GROUND GREY MOSAIC SF/30x30/C/R	GROUND	23438	P-37	30x30x1	8	15,9	101
D.GROUND GREY SPAC SF/30x30/C/R	GROUND	23506	P-58	30x30x1	8	15,6	101
D.GROUND SILVER MOSAIC SF/30x30/C/R	GROUND	23439	P-37	30x30x1	8	15,9	101
D.GROUND SILVER SPAC SF/30x30/C/R	GROUND	23507	P-58	30x30x1	8	15,6	101
D.GRUNGE ANTH MOSAIC/AS/30x30/C	GRUNGE FLOOR	27603	P-37	30x30x1	8	15,6	107
D.GRUNGE ANTH SPAC/AS/30x30/C	GRUNGE FLOOR	27608	P-58	30x30x1	8	15,9	107
D.GRUNGE BEIGE MOSAIC/AS/30x30/C	GRUNGE FLOOR	27605	P-37	30x30x1	8	15,6	107
D.GRUNGE BEIGE SPAC/AS/30x30/C	GRUNGE FLOOR	27609	P-58	30x30x1	8	15,9	107
D.GRUNGE BEIGE WALL MOSAIC/30x30	GRUNGE WALL	27613	P-44	30x30x1,05	8	11	209
D.GRUNGE GREY MOSAIC/AS/30x30/C	GRUNGE FLOOR	27606	P-37	30x30x1	8	15,6	107
D.GRUNGE GREY SPAC/AS/30x30/C	GRUNGE FLOOR	27610	P-58	30x30x1	8	15,9	107
D.GRUNGE GREY WALL MOSAIC/30x30	GRUNGE WALL	27614	P-44	30x30x1,05	8	11	209
D.GRUNGE WHITE MOSAIC/AS/30x30/C	GRUNGE FLOOR	27607	P-37	30x30x1	8	15,6	107
D.GRUNGE WHITE SPAC/AS/30x30/C	GRUNGE FLOOR	27611	P-58	30x30x1	8	15,9	107
D.GRUNGE WHITE WALL MOSAIC/30x30	GRUNGE WALL	27612	P-44	30x30x1,05	8	11	209
D.LENK ASH CHEV.1 AS/32x28,6/C	LENK	27720	P-47	32x28x1	5	11,7	113
D.LENK ASH CHEV.2 AS/32x28,6/C	LENK	27727	P-47	32x28x1	5	11,7	113
D.LENK ASH STRIPES AS/24x75/C	LENK	27756	P-51	24x75x1	4	18,2	113
D.LENK ASH TANGRAM/30x30/C	LENK	27734	P-53	30x30x1	8	18,2	113
D.LENK HONEY CHEV.1 AS/32x28,6/C	LENK	27721	P-47	32x28x1	5	11,7	113
D.LENK HONEY CHEV.2 AS/32x28,6/C	LENK	27728	P-47	32x28x1	5	11,7	113
D.LENK HONEY STRIPES AS/24x75/C	LENK	27757	P-51	24x75x1	4	18,2	113
D.LENK HONEY TANGRAM/30x30/C	LENK	27735	P-53	30x30x1	8	18,2	113
D.LENK MAPLE CHEV.1 AS/32x28,6/C	LENK	27722	P-47	32x28x1	5	11,7	113
D.LENK MAPLE CHEV.2 AS/32x28,6/C	LENK	27729	P-47	32x28x1	5	11,7	113
D.LENK MAPLE STRIPES AS/24x75/C	LENK	27758	P-51	24x75x1	4	18,2	113
D.LENK MAPLE TANGRAM/30x30/C	LENK	27740	P-53	30x30x1	8	18,2	113
D.LENK SMOKE CHEV.1 AS/32x28,6/C	LENK	27723	P-47	32x28x1	5	11,7	113
D.LENK SMOKE CHEV.2 AS/32x28,6/C	LENK	27730	P-47	32x28x1	5	11,7	113
D.LENK SMOKE STRIPES AS/24x75/C	LENK	27759	P-51	24x75x1	4	18,2	113
D.LENK SMOKE TANGRAM/30x30/C	LENK	27741	P-53	30x30x1	8	18,2	113
D.LENK TAUPE CHEV.1 AS/32x28,6/C	LENK	27724	P-47	32x28x1	5	11,7	113

Artículo / Article	Serie	Ref.	Tarifa / Price list	Formato / Size	Pzs. caja / Pcs. box	Peso caja / Weight box	P.
D.LENK TAUPE CHEV.2 AS/32x28,6/C	LENK	27731	P-47	32x28x1	5	11,7	113
D.LENK TAUPE STRIPES AS/24x75/C	LENK	27760	P-51	24x75x1	4	18,2	113
D.LENK TAUPE TANGRAM/30x30/C	LENK	27742	P-53	30x30x1	8	18,2	113
D.LENK WALNUT CHEV.1 AS/32x28,6/C	LENK	27725	P-47	32x28x1	5	11,7	113
D.LENK WALNUT CHEV.2 AS/32x28,6/C	LENK	27732	P-47	32x28x1	5	11,7	113
D.LENK WALNUT STRIPES AS/24x75/C	LENK	27761	P-51	24x75x1	4	18,2	113
D.LENK WALNUT TANGRAM/30x30/C	LENK	27743	P-53	30x30x1	8	18,2	113
D.LENK WHITE CHEV.1 AS/32x28,6/C	LENK	27726	P-47	32x28x1	5	11,7	113
D.LENK WHITE CHEV.2 AS/32x28,6/C	LENK	27733	P-47	32x28x1	5	11,7	113
D.LENK WHITE STRIPES AS/24x75/C	LENK	27762	P-51	24x75x1	4	18,2	113
D.LENK WHITE TANGRAM/30x30/C	LENK	27744	P-53	30x30x1	8	18,2	113
D.MILA COLD MOSAIC/5F	GROUND	23442	P-37	30x30x1	8	15,9	101
D.MILA WARM MOSAIC/5F	GROUND	23441	P-37	30x30x1	8	15,9	101
D.MYSTIC ANTH BRICK/29,8x29,2	MYSTIC 4D	24458	P-50	29,8x29,2x0,8	8	12,2	141
D.MYSTIC ANTH MOSAIC/25x25	MYSTIC 4D	24476	P-39	25x25x0,8	8	7,7	141
D.MYSTIC GREY BRICK/29,8x29,2	MYSTIC 4D	24459	P-50	29,8x29,2x0,8	8	12,2	141
D.MYSTIC GREY MOSAIC/25x25	MYSTIC 4D	24477	P-39	25x25x0,8	8	7,7	141
D.MYSTIC SAND BRICK/29,8x29,2	MYSTIC 4D	24461	P-50	29,8x29,2x0,8	8	12,2	141
D.MYSTIC SAND MOSAIC/25x25	MYSTIC 4D	24479	P-39	25x25x0,8	8	7,7	141
D.MYSTIC WHITE BRICK/29,8x29,2	MYSTIC 4D	25427	P-50	29,8x29,2x0,8	8	12,2	141
D.MYSTIC WHITE MOSAIC/25x25	MYSTIC 4D	25428	P-39	25x25x0,8	8	7,7	141
D.NATURE ANTH MOSAIC SF/30x30/C/R	NATURE FLOOR	26082	P-37	30x30x1	8	15,9	145
D.NATURE ANTH SPAC SF/30x30/C/R	NATURE FLOOR	26097	P-58	30x30x1	8	15,9	145
D.NATURE BEIGE MOSAIC SF/30x30/C/R	NATURE FLOOR	26083	P-37	30x30x1	8	15,9	145
D.NATURE BEIGE SPAC SF/30x30/C/R	NATURE FLOOR	26098	P-58	30x30x1	8	15,6	145
D.NATURE GREY MOSAIC SF/30x30/C/R	NATURE FLOOR	26084	P-37	30x30x1	8	15,9	145
D.NATURE GREY SPAC SF/30x30/C/R	NATURE FLOOR	26099	P-58	30x30x1	8	15,6	145
D.NATURE SAND WALL MOSAIC/30x30	NATURE WALL	30870	P-44	30x30x1,05	8	11	237
D.NATURE SILVER WALL MOSAIC/30x30	NATURE WALL	30871	P-44	30x30x1,05	8	11	237
D.NATURE WHITE MOSAIC SF/30x30/C/R	NATURE FLOOR	26086	P-37	30x30x1	8	15,9	145
D.NATURE WHITE SPAC SF/30x30/C/R	NATURE FLOOR	26101	P-58	30x30x1	8	15,6	145
D.NATURE WHITE WALL MOSAIC/30x30	NATURE WALL	26299	P-37	30x30x1,05	8	11	237
D.PALETTE ASH MOSAIC/31,5x31,5	PALETTE	26169	P-56	31,5x31,5x1,05	7	14,6	239
D.PALETTE BLUE MOSAIC/31,5x31,5	PALETTE	26180	P-56	31,5x31,5x1,05	7	14,6	239
D.PALETTE ECRU MOSAIC/31,5x31,5	PALETTE	26181	P-56	31,5x31,5x1,05	7	14,6	239
D.PALETTE FOG MOSAIC/31,5x31,5	PALETTE	26182	P-56	31,5x31,5x1,05	7	14,6	239
D.PALETTE GREEN MOSAIC/31,5x31,5	PALETTE	26183	P-56	31,5x31,5x1,05	7	14,6	239
D.PALETTE TAUPE MOSAIC/31,5x31,5	PALETTE	26184	P-56	31,5x31,5x1,05	7	14,6	239
D.PLANET ANTH MOSAIC SF/30x30/C/R	PLANET	22502	P-37	30x30x1	8	15,9	149
D.PLANET BONE MOSAIC SF/30x30/C/R	PLANET	22505	P-37	30x30x1	8	15,9	149
D.PLANET MUD MOSAIC SF/30x30/C/R	PLANET	22506	P-37	30x30x1	8	15,9	149
D.PLANET SILVER MOSAIC SF/30x30/C/R	PLANET	22504	P-37	30x30x1	8	15,9	149
D.PLANET WHITE MOSAIC SF/30x30/C/R	PLANET	25800	P-37	30x30x1	8	15,9	149
D.SALINES BONE MOSAIC/30x30	SALINES	23322	P-44	30x30x0,7	11	16,7	251
D.SALINES MIX MOSAIC/30x30	SALINES	23320	P-44	30x30x0,7	11	11,2	251
D.SALINES SILVER MOSAIC/30x30	SALINES	23323	P-44	30x30x0,7	11	16,7	251
D.SALINES WHITE MOSAIC/30x30	SALINES	23321	P-44	30x30x0,7	11	16,7	251
D.SATYER-B/5	SATYA	21424	P-45	30x30x1	8	15,9	153
D.SATYER-G/5	SATYA	21416	P-45	30x30x1	8	15,9	153
D.SATYER-H/5	SATYA	21415	P-45	30x30x1	8	15,9	153
D.VERBIER ASH CHEV AS/27,5x24/C	VERBIER	32092	P-53	27,5x24x1	8	11,3	159
D.VERBIER CHERRY CHEV AS/27,5x24/C	VERBIER	32093	P-53	27,5x24x1	8	11,3	159
D.VERBIER CIGAR CHEV AS/27,5x24/C	VERBIER	32094	P-53	27,5x24x1	8	11,3	159

Artículo / Article	Serie	Ref.	Tarifa / Price list	Formato / Size	Pzs. caja / Pcs. box	Peso caja / Weight box	P.
D.VERBIER HONEY CHEV AS/27,5x24/C	VERBIER	32095	P-53	27,5x24x1	8	11,3	159
D.VERBIER MAPLE CHEV AS/27,5x24/C	VERBIER	32096	P-53	27,5x24x1	8	11,3	159
D.VERBIER STRAW CHEV AS/27,5x24/C	VERBIER	32097	P-53	27,5x24x1	8	11,3	159
D.VERBIER TAUPE CHEV AS/27,5x24/C	VERBIER	32098	P-53	27,5x24x1	8	11,3	159
DANUBIO-G	DANUBIO	14364	BN-21	33x91x1,05	4	21,8	181
DANUBIO-G/R	DANUBIO	14430	BN-29	32x90x1,05	4	20,9	181
DANUBIO-H	DANUBIO	14365	BN-21	33x91x1,05	4	21,8	181
DANUBIO-H/R	DANUBIO	14431	BN-29	32x90x1,05	4	20,9	181
DONNA SAND DECOR/33,3x100/R	DONNA	27539	BN-66	33,3x100x0,86	5	22,5	183
DONNA SAND/33,3x100/R	DONNA	27534	BN-65	33,3x100x0,75	6	24,9	183
DONNA SILVER DECOR/33,3x100/R	DONNA	27538	BN-66	33,3x100x0,86	5	22,5	183
DONNA SILVER/33,3x100/R	DONNA	27535	BN-65	33,3x100x0,75	6	24,9	183
DONNA WHITE DECOR/33,3x100/R	DONNA	27537	BN-66	33,3x100x0,86	5	22,5	183
DONNA WHITE/33,3x100/R	DONNA	27536	BN-65	33,3x100x0,75	6	24,9	183
DOWNTOWN ANTH NT/60x60/C/R	DOWNTOWN FLOOR	29698	BN-33	60x60x1	3	24,3	77
DOWNTOWN ANTH SP/100x100/R	DOWNTOWN 4D	31012	BN-135	100x100x0,6	2	29,9	73
DOWNTOWN ANTH SP/100x180/R	DOWNTOWN 4D	31345	BN-137	100x180x0,6	2	52,9	73
DOWNTOWN ANTH SP/60x120/R	DOWNTOWN FLOOR	29695	BN-6	60x120x1	2	33,2	77
DOWNTOWN ANTH SP/90x90/R	DOWNTOWN FLOOR	29713	BN-7	90x90x1	2	38	77
DOWNTOWN ANTH/90x90/A/R	DOWNTOWN FLOOR	30733	BN-90	90x90x1	2	38	77
DOWNTOWN BEIGE MATERIAL SP/33,3x100/R	DOWNTOWN WALL	30754	BN-10	33,3x100x0,86	5	22,5	185
DOWNTOWN BEIGE NT/60x60/C/R	DOWNTOWN FLOOR	29700	BN-33	60x60x1	3	24,3	77
DOWNTOWN BEIGE SP/100x100/R	DOWNTOWN 4D	31013	BN-135	100x100x0,6	2	29,9	73
DOWNTOWN BEIGE SP/100x180/R	DOWNTOWN 4D	31346	BN-137	100x180x0,6	2	52,9	73
DOWNTOWN BEIGE SP/33,3x100/R	DOWNTOWN WALL	29725	BN-8	33,3x100x0,75	6	24,9	185
DOWNTOWN BEIGE SP/60x120/R	DOWNTOWN FLOOR	29696	BN-6	60x120x1	2	33,2	77
DOWNTOWN BEIGE SP/90x90/R	DOWNTOWN FLOOR	29714	BN-7	90x90x1	2	38	77
DOWNTOWN BEIGE TRIANGLE SP/33,3x100/R	DOWNTOWN WALL	29727	BN-10	33,3x100x0,86	5	22,5	185
DOWNTOWN BEIGE/90x90/A/R	DOWNTOWN FLOOR	30738	BN-90	90x90x1	2	38	77
DOWNTOWN GREY MATERIAL SP/33,3x100/R	DOWNTOWN WALL	30756	BN-10	33,3x100x0,86	5	22,5	185
DOWNTOWN GREY NT/60x60/C/R	DOWNTOWN FLOOR	29699	BN-33	60x60x1	3	24,3	77
DOWNTOWN GREY SP/100x100/R	DOWNTOWN						

Artículo / Article	Serie	Ref.	Tarifa / Price list	Formato / Size	Pzs. caja / Pcs. box	Peso caja / Weight box	P.
FS FIELD BLUE LT	FS FIELD	36383	BN-151	45,2x45,2x0,87	5	19,6	287
FS FIELD BROWN LT	FS FIELD	36384	BN-151	45,2x45,2x0,87	5	19,6	287
FS FOREST BLACK	FS FOREST	34443	BN-14	45x45x0,95	5	21	291
FS FOREST NATURAL	FS FOREST	34444	BN-14	45x45x0,95	5	21	291
FS FOREST PLANK NATURAL	FS FOREST	34881	BN-146	7,3x45x1,05	25	21	291
FS FOREST WHITE	FS FOREST	34442	BN-14	45x45x0,95	5	22,7	291
FS HERITAGE LEAVES LT	FS HERITAGE	30895	BN-17	45x45x0,95	5	21	295
FS HERITAGE ORNATE LT	FS HERITAGE	30894	BN-17	45x45x0,95	5	21	295
FS HERITAGE SQUARE LT	FS HERITAGE	30893	BN-17	45x45x0,95	5	21	295
FS HERITAGE WHITE LT	FS HERITAGE	30892	BN-17	45x45x0,95	5	21	295
FS IRON OXIDE LT	FS IRON	34446	BN-18	20x40x1,03	12	16,3	297
FS IRON WHITE LT	FS IRON	34447	BN-18	20x40x1,03	12	16,3	297
FS IVY BLACK	FS IVY	26170	BN-14	45x45x0,95	5	21	298
FS IVY BLUE	FS IVY	26171	BN-14	45x45x0,95	5	21	298
FS IVY SAGE	FS IVY	26172	BN-14	45x45x0,95	5	21	298
FS JAIPUR BLACK LT	FS JAIPUR	34438	BN-17	45x45x0,95	5	21	299
FS JAIPUR WHITE LT	FS JAIPUR	34439	BN-17	45x45x0,95	5	21	299
FS LOFT BLACK	FS LOFT	34450	BN-18	20x40x1,03	12	16,3	303
FS LOFT CLAY	FS LOFT	34451	BN-18	20x40x1,03	12	16,3	303
FS LOFT WHITE	FS LOFT	34449	BN-18	20x40x1,03	12	16,3	303
FS MANISES-B	FS FAENZA	13621	BN-14	33x33x0,95	10	21,4	285
FS MARAIS	FS MARAIS	24268	BN-61	45,2x45,2x0,87	5	19,6	305
FS MARRAKECH BLUE	FS MARRAKECH	21936	BN-14	45x45x0,95	5	21	306
FS MARRAKECH GREY	FS MARRAKECH	21937	BN-14	45x45x0,95	5	21	306
FS MELVIN COLOR	FS MELVIN	20032	BN-73	7,4x67,5x1,05	15	17,1	307
FS MELVIN WHITE	FS MELVIN	20033	BN-73	7,4x67,5x1,05	15	17,1	307
FS MIRABEL-A	FS MIRABEL	20300	BN-14	33x33x0,95	10	21,4	308
FS MIRABEL-B	FS MIRABEL	20527	BN-14	33x33x0,95	10	21,4	308
FS MIRABEL-M	FS MIRABEL	20301	BN-14	33x33x0,95	10	21,4	308
FS MUD COCOA	FS MUD	29760	BN-3	20x40x1,03	12	16,3	309
FS MUD SAND	FS MUD	29761	BN-3	20x40x1,03	12	16,3	309
FS MUD SILVER	FS MUD	29758	BN-3	20x40x1,03	12	16,3	309
FS MUD WHITE	FS MUD	29759	BN-3	20x40x1,03	12	16,3	309
FS NIJAR	FS ORIGINAL	20402	BN-14	45x45x0,95	5	21	315
FS NORWICH	FS NORWICH	22058	BN-61	33x33x0,95	10	21,7	312
FS OFELIA	FS OFELIA	21076	BN-61	45,2x45,2x0,87	5	19,6	313
FS OLDKER	FS ARTISAN	20302	BN-14	33x33x0,95	10	21,4	271
FS PORTO AMARAL	FS PORTO	31653	BN-14	45x45x0,95	5	21	317
FS PORTO FATIMA	FS PORTO	31654	BN-14	45x45x0,95	5	21	317
FS PORTO FLAVIA	FS PORTO	31655	BN-14	45x45x0,95	5	21	317
FS PORTO IRIA	FS PORTO	31656	BN-14	45x45x0,95	5	21	317
FS RAKU BLACK	FS RAKU	28941	BN-3	20x40x1,03	12	16,3	319
FS RAKU BLUE	FS RAKU	28939	BN-3	20x40x1,03	12	16,3	319
FS RAKU COLORS	FS RAKU	28944	BN-3	20x40x1,03	12	16,3	319
FS RAKU CREAM	FS RAKU	28942	BN-3	20x40x1,03	12	16,3	319
FS RAKU SAGE	FS RAKU	28940	BN-3	20x40x1,03	12	16,3	319
FS RAKU SILVER	FS RAKU	28943	BN-3	20x40x1,03	12	16,3	319
FS RAKU WHITE	FS RAKU	28938	BN-3	20x40x1,03	12	16,3	319
FS ROAD MARS AS/90x90/C/R	FS ROAD	36372	BN-150	90x90x1	2	38	321
FS ROAD MOON AS/90x90/C/R	FS ROAD	36373	BN-150	90x90x1	2	38	321
FS ROCK AS	FS ROCKSTAR	36381	BN-149	45,2x45,2x0,87	5	19,6	325
FS ROCKSTAR-N AS	FS ROCKSTAR	36379	BN-149	45,2x45,2x0,87	5	19,6	325

Artículo / Article	Serie	Ref.	Tarifa / Price list	Formato / Size	Pzs. caja / Pcs. box	Peso caja / Weight box	P.
FS ROMBOS-N	FS DAMERO	16447	BN-14	45x45x0,95	5	21	281
FS ROOTS-0	FS ROOTS	29295	BN-14	45x45x0,95	5	21	327
FS ROOTS-1	FS ROOTS	28888	BN-14	45x45x0,95	5	21	327
FS ROOTS-2	FS ROOTS	28889	BN-14	45x45x0,95	5	21	327
FS ROOTS-3	FS ROOTS	28890	BN-14	45x45x0,95	5	21	327
FS ROOTS-4	FS ROOTS	28891	BN-14	45x45x0,95	5	21	327
FS RUE	FS VENDOME	24266	BN-61	45,2x45,2x0,87	5	19,6	344
FS SABI	FS WABI SABI	32446	BN-14	45x45x0,95	5	21	347
FS SAJA-B	FS SAJA	20087	BN-14	33x33x0,95	10	21,4	328
FS SAJA-N	FS SAJA	20086	BN-14	33x33x0,95	10	21,4	328
FS SEA BLUE LT	FS SEA	32444	BN-17	33x33x0,95	10	21,4	329
FS SEA WHITE LT	FS SEA	32445	BN-17	33x33x0,95	10	21,4	329
FS SEAL	FS CLAY	30066	BN-14	45x45x0,95	5	21	277
FS SEATTLE	FS SEATTLE	18152	BN-61	30x30x0,8	12	20,5	330
FS SENA BLUE	FS SENA	24267	BN-61	45,2x45,2x0,87	5	19,6	331
FS STAR ARA BLACK	FS STAR	28148	BN-14	45x45x0,95	5	21	333
FS STAR BLACK LT	FS STAR LT	32447	BN-17	45x45x0,95	5	21	337
FS STAR BLUE	FS STAR	32200	BN-14	45x45x0,95	5	21	333
FS STAR BLUE LT	FS STAR LT	32448	BN-17	45x45x0,95	5	21	337
FS STAR NIGHT	FS STAR	28146	BN-14	45x45x0,95	5	21	333
FS STAR OXIDE	FS STAR	23198	BN-14	45x45x0,95	5	21	333
FS STAR SAGE	FS STAR	23199	BN-14	45x45x0,95	5	21	333
FS STAR SAGE LT	FS STAR LT	32449	BN-17	45x45x0,95	5	21	337
FS STAR SKY	FS STAR	28147	BN-14	45x45x0,95	5	21	333
FS STAR WHITE	FS STAR	27325	BN-14	45x45x0,95	5	21	333
FS STAR WHITE LT	FS STAR LT	33214	BN-17	45x45x0,95	5	21	337
FS STAR-N	FS STAR	19136	BN-14	45x45x0,95	5	21	333
FS TEMPLE BLACK	FS TEMPLE	24713	BN-14	45x45x0,95	5	21	341
FS TEMPLE BLUE	FS TEMPLE	24716	BN-14	45x45x0,95	5	21	341
FS TEMPLE OXIDE	FS TEMPLE	24715	BN-14	45x45x0,95	5	21	341
FS TEMPLE SAGE	FS TEMPLE	24714	BN-14	45x45x0,95	5	21	341
FS TRADITION BRICK BLUE LT	FS TRADITION	30898	BN-18	20x40x1,03	12	16,3	343
FS TRADITION BRICK GREEN LT	FS TRADITION	31131	BN-18	20x40x1,03	12	16,3	343
FS TRADITION BRICK SILVER LT	FS TRADITION	30897	BN-18	20x40x1,03	12	16,3	343
FS TRADITION BRICK WHITE LT	FS TRADITION	30961	BN-18	20x40x1,03	12	16,3	343
FS TRADITION SQUARE BLUE LT	FS TRADITION	30899	BN-18	20x40x1,03	12	16,3	343
FS TRADITION SQUARE GREEN LT	FS TRADITION	31132	BN-18	20x40x1,03	12	16,3	343
FS TRADITION SQUARE SILVER LT	FS TRADITION	30962	BN-18	20x40x1,03	12	16,3	343
FS TRADITION SQUARE WHITE LT	FS TRADITION	30896	BN-18	20x40x1,03	12	16,3	343
FS VENDOME	FS VENDOME	24269	BN-61	45,2x45,2x0,87	5	19,6	344
FS VENECIA/46	FS VENECIA	21078	BN-61	45,2x45,2x0,87	5	19,6	345
FS VENECIA/60x60/R	FS VENECIA	25659	BN-91	60x60x1	3	25,2	345
FS WABI	FS WABI SABI	32443	BN-14	33x33x0,95	10	21,4	347
FS WABI ARROW	FS WABI SABI	32442	BN-14	33x33x0,95	10	21,4	347
FS WILD AS/19,5x121,5/C/R	FS WILD	36330	BN-152	19,5x121,5x1	4	22,2	349
FS YARD BLACK	FS YARD	26173	BN-14	45x45x0,95	5	21	351
FS YARD BLUE	FS YARD	26174	BN-14	45x45x0,95	5	21	351
FS YARD SAGE	FS YARD	26175	BN-14	45x45x0,95	5	21	351
FS-0	FS ORIGINAL	13305	BN-14	45x45x0,95	5	21	315
FS-1	FS ORIGINAL	12500	BN-14	45x45x0,95	5	21	315
FS-2	FS ORIGINAL	12501	BN-14	45x45x0,95	5	21	315
FS-3	FS ORIGINAL	12519	BN-14	45x45x0,95	5	21	315

Artículo / Article	Serie	Ref.	Tarifa / Price list	Formato / Size	Pzs. caja / Pcs. box	Peso caja / Weight box	P.
FS-4	FS ORIGINAL	12541	BN-14	45x45x0,95	5	21	315
GHENT BEIGE AS/60x120/C/R	GHENT FLOOR	31753	BN-116	60x120x1	2	33,2	87
GHENT BEIGE AS/90x90/C/R	GHENT FLOOR	31891	BN-90	90x90x1	2	38	87
GHENT BEIGE DEC SP/33,3x100/R	GHENT WALL	31863	BN-10	33,3x100x0,86	5	22,5	197
GHENT BEIGE NT/60x60/C/R	GHENT FLOOR	31755	BN-33	60x60x1	3	24,3	87
GHENT BEIGE SP/100x100/R	GHENT 4D	31747	BN-135	100x100x0,8	2	39,3	81
GHENT BEIGE SP/100x180/R	GHENT 4D	33200	BN-137	100x180x0,6	2	52,9	81
GHENT BEIGE SP/100x275/R	GHENT 4D	35597	BN-141	100x275x0,6	1	38,5	81
GHENT BEIGE SP/100x275/R	GHENT 4D	35597	BN-141	100x275x0,6	1	38,5	81
GHENT BEIGE SP/33,3x100/R	GHENT WALL	31860	BN-8	33,3x100x0,75	6	24,9	197
GHENT BEIGE/100x100/A/R	GHENT 4D	33948	BN-144	100x100x0,8	2	39,3	81
GHENT BEIGE/100x100x2/A/R	GHENT 4D	34878	BN-145	100x100x2	1	49,2	81
GHENT BEIGE/50x100x2/A/R	GHENT 4D	35567	BN-147	50x100x2	1	24,7	81
GHENT GREY AS/60x120/C/R	GHENT FLOOR	31751	BN-116	60x120x1	2	33,2	87
GHENT GREY AS/90x90/C/R	GHENT FLOOR	31892	BN-90	90x90x1	2	38	87
GHENT GREY NT/60x60/C/R	GHENT FLOOR	31756	BN-33	60x60x1	3	24,3	87
GHENT GREY SP/100x100/R	GHENT 4D	31749	BN-135	100x100x0,8	2	39,3	81
GHENT GREY SP/100x180/R	GHENT 4D	33202	BN-137	100x180x0,6	2	52,9	81
GHENT GREY SP/100x275/R	GHENT 4D	35598	BN-141	100x275x0,6	1	38,5	81
GHENT GREY/100x100/A/R	GHENT 4D	33947	BN-144	100x100x0,8	2	39,3	81
GHENT GREY/100x100x2/A/R	GHENT 4D	34734	BN-145	100x100x2	1	49,2	81
GHENT GREY/50x100x2/A/R	GHENT 4D	35568	BN-147	50x100x2	1	24,7	81
GHENT SILVER AS/60x120/C/R	GHENT FLOOR	31752	BN-116	60x120x1	2	33,2	87
GHENT SILVER AS/90x90/C/R	GHENT FLOOR	31893	BN-90	90x90x1	2	38	87
GHENT SILVER DEC SP/33,3x100/R	GHENT WALL	31864	BN-10	33,3x100x0,86	5	22,5	197
GHENT SILVER NT/60x60/C/R	GHENT FLOOR	31757	BN-33	60x60x1	3	24,3	87
GHENT SILVER SP/100x100/R	GHENT 4D	31748	BN-135	100x100x0,8	2	39,3	81
GHENT SILVER SP/100x180/R	GHENT 4D	33201	BN-137	100x180x0,6	2	52,9	81
GHENT SILVER SP/100x275/R	GHENT 4D	35599	BN-141	100x275x0,6	1	38,5	81
GHENT SILVER SP/33,3x100/R	GHENT WALL	31862	BN-8	33,3x100x0,75	6	24,9	197
GHENT SILVER/100x100/A/R	GHENT 4D	33946	BN-144	100x100x0,8	2	39,3	81
GHENT SILVER/100x100x2/A/R	GHENT 4D	34733	BN-145	100x100x2	1	49,2	81
GHENT SILVER/50x100x2/A/R	GHENT 4D	35569	BN-147	50x100x2	1	24,7	81
GHENT WHITE AS/60x120/C/R	GHENT FLOOR	31750	BN-116	60x120x1	2	33,2	87
GHENT WHITE AS/90x90/C/R	GHENT FLOOR	31894	BN-90	90x90x1	2	38	87
GHENT WHITE DEC SP/33,3x100/R	GHENT WALL	31865	BN-10	33,3x100x0,86	5	22,5	197
GHENT WHITE NT/60x60/C/R	GHENT FLOOR	31754	BN-33	60x60x1	3	24,3	87
GHENT WHITE SP/100x100/R	GHENT 4D	31746	BN-136	100x100x0,8	2	39,3	81
GHENT WHITE SP/100x180/R	GHENT 4D	33203	BN-138	100x180x0,8	2	70,9	81
GHENT WHITE SP/100x275/R	GHENT 4D	35600	BN-142	100x275x0,6	1	38,5	81
GHENT WHITE SP/33,3x100/R	GHENT WALL	31861	BN-8	33,3x100x0,75	6	24,9	1

Artículo / Article	Serie	Ref.	Tarifa / Price list	Formato / Size	Pzs. caja / Pcs. box	Peso caja / Weight box	P.
GRUNGE BEIGE/25x75	GRUNGE WALL	27158	BN-16	25x75x1,05	7	24,7	209
GRUNGE BEIGE/32x90/R	GRUNGE WALL	27491	BN-29	32x90x1,05	4	20,9	209
GRUNGE GREY AS/60x120/C/R	GRUNGE FLOOR	27402	BN-116	60x120x1	2	33,2	107
GRUNGE GREY AS/60x60/C/R	GRUNGE FLOOR	27411	BN-88	60x60x1	3	24,3	107
GRUNGE GREY AS/75,5x151/C/R	GRUNGE FLOOR	27434	BN-119	75,5x151x1	1	26	107
GRUNGE GREY AS/90x90/C/R	GRUNGE FLOOR	27426	BN-90	90x90x1	2	38	107
GRUNGE GREY DECOR/25x75	GRUNGE WALL	27160	BN-20	25x75x1,05	7	24,7	209
GRUNGE GREY PEAK/32x90/R	GRUNGE WALL	27496	BN-36	32x90x1,05	4	20,9	209
GRUNGE GREY STRIPES/32x90/R	GRUNGE WALL	27494	BN-36	32x90x1,05	4	20,9	209
GRUNGE GREY/25x75	GRUNGE WALL	27157	BN-16	25x75x1,05	7	24,7	209
GRUNGE GREY/32x90/R	GRUNGE WALL	27492	BN-29	32x90x1,05	4	20,9	209
GRUNGE WHITE AS/60x120/C/R	GRUNGE FLOOR	27399	BN-116	60x120x1	2	33,2	107
GRUNGE WHITE AS/60x60/C/R	GRUNGE FLOOR	27408	BN-88	60x60x1	3	24,3	107
GRUNGE WHITE AS/75,5x151/C/R	GRUNGE FLOOR	27435	BN-119	75,5x151x1	1	26	107
GRUNGE WHITE AS/90x90/C/R	GRUNGE FLOOR	27427	BN-90	90x90x1	2	38	107
GRUNGE WHITE DECOR/25x75	GRUNGE WALL	27161	BN-20	25x75x1,05	7	24,7	209
GRUNGE WHITE PEAK/32x90/R	GRUNGE WALL	27497	BN-36	32x90x1,05	4	20,9	209
GRUNGE WHITE STRIPES/32x90/R	GRUNGE WALL	27495	BN-36	32x90x1,05	4	20,9	209
GRUNGE WHITE/25x75	GRUNGE WALL	27156	BN-16	25x75x1,05	7	24,7	209
GRUNGE WHITE/32x90/R	GRUNGE WALL	27490	BN-29	32x90x1,05	4	20,9	209
HV-1	HOUSE OF VANITY	14644	BN-61	33x33x0,9	10	22,2	111
HV-2	HOUSE OF VANITY	14645	BN-61	33x33x0,9	10	22,2	111
HV-3	HOUSE OF VANITY	14646	BN-61	33x33x0,9	10	22,2	111
HV-4	HOUSE OF VANITY	14647	BN-61	33x33x0,9	10	22,2	111
ICE DIAMOND/33,3x100/R	ICE	30858	BN-5	33,3x100x0,86	5	22,5	217
ICE FOLD/33,3x100/R	ICE	30859	BN-5	33,3x100x0,86	5	22,5	217
ICE WAVES/33,3x100/R	ICE	30857	BN-5	33,3x100x0,86	5	22,5	217
ICE/33,3x100/R	ICE	30853	BN-4	33,3x100x0,75	6	24,9	217
LFS BRASS/22,3	FS YARD	27779	P-43	1x22,3x1	24	1,6	351
LFS RAKU GOLD/1,5x20	FS RAKU	29177	P-14	1,5x20x0,8	80	8,2	319
L.PALETTE ASH/3x90/R	PALETTE	26163	P-38	3x90x1,05	14	7,1	239
L.PALETTE BLUE/3x90/R	PALETTE	26164	P-38	3x90x1,05	14	7,1	239
L.PALETTE ECRU/3x90/R	PALETTE	26165	P-38	3x90x1,05	14	7,1	239
L.PALETTE FOG/3x90/R	PALETTE	26166	P-38	3x90x1,05	14	7,1	239
L.PALETTE GREEN/3x90/R	PALETTE	26167	P-38	3x90x1,05	14	7,1	239
L.PALETTE TAUPE/3x90/R	PALETTE	26168	P-38	3x90x1,05	14	7,1	239
LACCIO CEMENT-G/R	LACCIO	18503	BN-36	32x90x1,05	4	20,9	223
LACCIO CEMENT-H/R	LACCIO	18502	BN-36	32x90x1,05	4	20,9	223
LACCIO WOOD-G/R	LACCIO	18501	BN-36	32x90x1,05	4	20,9	223
LACCIO WOOD-H/R	LACCIO	18500	BN-36	32x90x1,05	4	20,9	223
LACCIO-W/R	LACCIO	18158	BN-36	32x90x1,05	4	20,9	223
LENK ASH AS/19,5x121,5/C/R	LENK	28315	BN-95	19,5x121,5x1	4	22,2	113
LENK ASH AS/24x151/C/R	LENK	27397	BN-121	24x151x1	3	24,3	113
LENK HONEY AS/19,5x121,5/C/R	LENK	28316	BN-95	19,5x121,5x1	4	22,2	113
LENK HONEY AS/24x151/C/R	LENK	27237	BN-121	24x151x1	3	24,3	113
LENK MAPLE AS/19,5x121,5/C/R	LENK	28317	BN-95	19,5x121,5x1	4	22,2	113
LENK MAPLE AS/24x151/C/R	LENK	27238	BN-121	24x151x1	3	24,3	113
LENK SMOKE AS/19,5x121,5/C/R	LENK	28318	BN-95	19,5x121,5x1	4	22,2	113
LENK SMOKE AS/24x151/C/R	LENK	27398	BN-121	24x151x1	3	24,3	113
LENK TAUPE AS/19,5x121,5/C/R	LENK	28319	BN-95	19,5x121,5x1	4	22,2	113
LENK TAUPE AS/24x151/C/R	LENK	27236	BN-121	24x151x1	3	24,3	113
LENK WALNUT AS/19,5x121,5/C/R	LENK	28320	BN-95	19,5x121,5x1	4	22,2	113

Artículo / Article	Serie	Ref.	Tarifa / Price list	Formato / Size	Pzs. caja / Pcs. box	Peso caja / Weight box	P.
LENK WALNUT AS/24x151/C/R	LENK	27239	BN-121	24x151x1	3	24,3	113
LENK WHITE AS/19,5x121,5/C/R	LENK	28321	BN-95	19,5x121,5x1	4	22,2	113
LENK WHITE AS/24x151/C/R	LENK	27475	BN-121	24x151x1	3	24,3	113
LUCCA ANTH AS/60x120/C/R	LUCCA FLOOR	29852	BN-116	60x120x1	2	33,2	123
LUCCA ANTH AS/90x90/C/R	LUCCA FLOOR	29856	BN-90	90x90x1	2	38	123
LUCCA ANTH HO/60x120/L/R	LUCCA FLOOR	30105	BN-132	60x120x1	2	33,2	123
LUCCA ANTH HO/90x90/L/R	LUCCA FLOOR	30099	BN-131	90x90x1	2	38	123
LUCCA ANTH NT/60x60/C/R	LUCCA FLOOR	31354	BN-33	60x60x1	3	24,3	123
LUCCA ANTH SF/60x120/R	LUCCA FLOOR	30109	BN-72	60x120x1	2	33,2	123
LUCCA ANTH SF/90x90/R	LUCCA FLOOR	30101	BN-48	90x90x1	2	38	123
LUCCA ANTH SP/100x100/R	LUCCA 4D	32881	BN-135	100x100x0,6	2	29,9	117
LUCCA ANTH SP/100x180/R	LUCCA 4D	29848	BN-137	100x180x0,6	2	52,9	117
LUCCA BEIGE AS/60x120/C/R	LUCCA FLOOR	29855	BN-116	60x120x1	2	33,2	123
LUCCA BEIGE AS/90x90/C/R	LUCCA FLOOR	29858	BN-90	90x90x1	2	38	123
LUCCA BEIGE DECOR SP/33,3x100/R	LUCCA WALL	31794	BN-10	33,3x100x0,86	5	22,5	225
LUCCA BEIGE HO/60x120/L/R	LUCCA FLOOR	30106	BN-132	60x120x1	2	33,2	123
LUCCA BEIGE HO/90x90/L/R	LUCCA FLOOR	30097	BN-131	90x90x1	2	38	123
LUCCA BEIGE NT/60x60/C/R	LUCCA FLOOR	31355	BN-33	60x60x1	3	24,3	123
LUCCA BEIGE SF/60x120/R	LUCCA FLOOR	30111	BN-72	60x120x1	2	33,2	123
LUCCA BEIGE SF/90x90/R	LUCCA FLOOR	30102	BN-48	90x90x1	2	38	123
LUCCA BEIGE SP/100x100/R	LUCCA 4D	32880	BN-135	100x100x0,6	2	29,9	117
LUCCA BEIGE SP/100x180/R	LUCCA 4D	29850	BN-137	100x180x0,6	2	52,9	117
LUCCA BEIGE SP/100x275/R	LUCCA 4D	35903	BN-141	100x275x0,6	1	38,5	117
LUCCA BEIGE SP/33,3x100/R	LUCCA WALL	31791	BN-8	33,3x100x0,75	6	24,9	225
LUCCA GREY AS/60x120/C/R	LUCCA FLOOR	29853	BN-116	60x120x1	2	33,2	123
LUCCA GREY AS/90x90/C/R	LUCCA FLOOR	29857	BN-90	90x90x1	2	38	123
LUCCA GREY DECOR SP/33,3x100/R	LUCCA WALL	31793	BN-10	33,3x100x0,86	5	22,5	225
LUCCA GREY HO/60x120/L/R	LUCCA FLOOR	30107	BN-132	60x120x1	2	33,2	123
LUCCA GREY HO/90x90/L/R	LUCCA FLOOR	30100	BN-131	90x90x1	2	38	123
LUCCA GREY NT/60x60/C/R	LUCCA FLOOR	31356	BN-33	60x60x1	3	24,3	123
LUCCA GREY SF/60x120/R	LUCCA FLOOR	30110	BN-72	60x120x1	2	33,2	123
LUCCA GREY SF/90x90/R	LUCCA FLOOR	30103	BN-48	90x90x1	2	38	123
LUCCA GREY SP/100x100/R	LUCCA 4D	32879	BN-135	100x100x0,6	2	29,9	117
LUCCA GREY SP/100x180/R	LUCCA 4D	29851	BN-137	100x180x0,6	2	52,9	117
LUCCA GREY SP/100x275/R	LUCCA 4D	35902	BN-141	100x275x0,6	1	38,5	117
LUCCA GREY SP/33,3x100/R	LUCCA WALL	31790	BN-8	33,3x100x0,75	6	24,9	225
LUCCA WHITE AS/60x120/C/R	LUCCA FLOOR	29854	BN-116	60x120x1	2	33,2	123
LUCCA WHITE AS/90x90/C/R	LUCCA FLOOR	29859	BN-90	90x90x1	2	38	123
LUCCA WHITE DECOR SP/33,3x100/R	LUCCA WALL	31792	BN-10	33,3x100x0,86	5	22,5	225
LUCCA WHITE HO/60x120/L/R	LUCCA FLOOR	30108	BN-132	60x120x1	2	33,2	123
LUCCA WHITE HO/90x90/L/R	LUCCA FLOOR	30098	BN-131	90x90x1	2	38	123
LUCCA WHITE NT/60x60/C/R	LUCCA FLOOR	31357	BN-33	60x60x1	3	24,3	123
LUCCA WHITE SF/60x120/R	LUCCA FLOOR	30112	BN-72	60x120x1	2	33,2	123
LUCCA WHITE SF/90x90/R	LUCCA FLOOR	30104	BN-48	90x90x1	2	38	123
LUCCA WHITE SP/100x100/R	LUCCA 4D	32878	BN-136	100x100x0,6	2	29,9	117
LUCCA WHITE SP/100x180/R	LUCCA 4D	29849	BN-138	100x180x0,6	2	52,9	117
LUCCA WHITE SP/100x275/R	LUCCA 4D	35901	BN-141	100x275x0,6	1	38,5	117
LUCCA WHITE SP/33,3x100/R	LUCCA WALL	31789	BN-8	33,3x100x0,75	6	24,9	225
M.FS MANISES-A	FS FAENZA	13668	P-22	5x11x0	24	2,6	285
M.FS MANISES-B	FS FAENZA	13670	P-22	5x11x0	24	2,6	285
M.FS MANISES-N	FS FAENZA	13669	P-22	5x11x0	24	2,6	285
MANHATTAN BONE AS/60x120/C/R	MANHATTAN FLOOR	34745	BN-116	60x120x1	2	33,2	133

Artículo / Article	Serie	Ref.	Tarifa / Price list	Formato / Size	Pzs. caja / Pcs. box	Peso caja / Weight box	P.
MANHATTAN BONE AS/60x60/C/R	MANHATTAN FLOOR	34750	BN-88	60x60x1	3	24,3	133
MANHATTAN BONE AS/90x90/C/R	MANHATTAN FLOOR	34747	BN-90	90x90x1	2	38	133
MANHATTAN BONE LINES SP/33,3x100/R	MANHATTAN WALL	34757	BN-10	33,3x100x0,86	5	22,5	229
MANHATTAN BONE SP/100x100/R	MANHATTAN 4D	34737	BN-135	100x100x0,8	2	39,3	127
MANHATTAN BONE SP/100x275/R	MANHATTAN 4D	34685	BN-141	100x275x0,6	1	38,5	127
MANHATTAN BONE SP/33,3x100/R	MANHATTAN WALL	34752	BN-8	33,3x100x0,75	6	24,9	229
MANHATTAN BONE WAVY SP/33,3x100/R	MANHATTAN WALL	34758	BN-10	33,3x100x0,86	5	22,5	229
MANHATTAN BONE/100x100/A/R	MANHATTAN 4D	34738	BN-144	100x100x0,8	2	39,3	127
MANHATTAN BONE/100x100x2/A/R	MANHATTAN 4D	36333	BN-145	100x100x2	1	49,2	127
MANHATTAN BONE/50x100x2/A/R	MANHATTAN 4D	36911	BN-147	50x100x2	1	24,7	127
MANHATTAN GREY AS/60x120/C/R	MANHATTAN FLOOR	34742	BN-116	60x120x1	2	33,2	133
MANHATTAN GREY AS/60x60/C/R	MANHATTAN FLOOR	34749	BN-88	60x60x1	3	24,3	133
MANHATTAN GREY AS/90x90/C/R	MANHATTAN FLOOR	34746	BN-90	90x90x1	2	38	133
MANHATTAN GREY SP/100x100/R	MANHATTAN 4D	34735	BN-135	100x100x0,8	2	39,3	127
MANHATTAN GREY SP/100x275/R	MANHATTAN 4D	34880	BN-141	100x275x0,6	1	38,5	127
MANHATTAN GREY/100x100/A/R	MANHATTAN 4D	34740	BN-144	100x100x0,8	2	39,3	127
MANHATTAN GREY/100x100x2/A/R	MANHATTAN 4D	36334	BN-145	100x100x2	1	49,2	127
MANHATTAN GREY/50x100x2/A/R	MANHATTAN 4D	36908	BN-147	50x100x2	1	24,7	127
MANHATTAN SILVER AS/60x120/C/R	MANHATTAN FLOOR	34744	BN-116	60x120x1	2	33,2	133
MANHATTAN SILVER AS/60x60/C/R	MANHATTAN FLOOR	34751	BN-88	60x60x1	3	24,3	133
MANHATTAN SILVER AS/90x90/C/R	MANHATTAN FLOOR	34748	BN-90	90x90x1	2	38	133
MANHATTAN SILVER LINES SP/33,3x100/R	MANHATTAN WALL	34755	BN-10	33,3x100x0,86	5	22,5	229
MANHATTAN SILVER SP/100x100/R	MANHATTAN 4D	34736	BN-135	100x100x0,8	2	39,3	127
MANHATTAN SILVER SP/100x275/R	MANHATTAN 4D	34686	BN-141	100x275x0,6	1	38,5	127
MANHATTAN SILVER SP/33,3x100/R	MANHATTAN WALL	34753	BN-8	33,3x100x0,75	6	24,9	229
MANHATTAN SILVER WAVY SP/33,3x100/R	MANHATTAN WALL	34756	BN-10	33,3x100x0,86	5	22,5	229
MANHATTAN SILVER/100x100/A/R	MANHATTAN 4D	34739	BN-144	100x100x0,8	2	39,3	127
MANHATTAN SILVER/100x100x2/A/R	MANHATTAN 4D	36335	BN-145	100x100x2	1	49,2	127
MANHATTAN SILVER/50x100x2/A/R	MANHATTAN 4D	36909	BN-147	50x100x2	1	24,7	127
MANHATTAN WHITE AS/60x120/C/R	MANHATTAN FLOOR	34872	BN-116	60x120x1	2	33,2	133
MANHATTAN WHITE AS/60x60/C/R	MANHATTAN FLOOR	34873	BN-88	60			

Artículo / Article	Serie	Ref.	Tarifa / Price list	Formato / Size	Pzs. caja / Pcs. box	Peso caja / Weight box	P.
NATURE GREY SF/90x90/C/R	NATURE FLOOR	25747	BN-48	90x90x1	2	38	145
NATURE SAND DECOR/32x90/R	NATURE WALL	24029	BN-36	32x90x1,05	4	20,9	237
NATURE SAND/32x90/R	NATURE WALL	24028	BN-29	32x90x1,05	4	20,9	237
NATURE SILVER DECOR/32x90/R	NATURE WALL	24030	BN-36	32x90x1,05	4	20,9	237
NATURE SILVER/32x90/R	NATURE WALL	24027	BN-29	32x90x1,05	4	20,9	237
NATURE WHITE BH/60x120/A/R	NATURE FLOOR	25829	BN-116	60x120x1	2	33,2	145
NATURE WHITE BH/60x60/A/R	NATURE FLOOR	25801	BN-88	60x60x1	3	24,3	145
NATURE WHITE BH/90x90/A/R	NATURE FLOOR	25755	BN-90	90x90x1	2	38	145
NATURE WHITE DECOR/32x90/R	NATURE WALL	26280	BN-36	32x90x1,05	4	20,9	237
NATURE WHITE SF/29x90/C/R	NATURE FLOOR	26212	BN-114	29x90x1	3	19	145
NATURE WHITE SF/60x120/C/R	NATURE FLOOR	25818	BN-72	60x120x1	2	33,2	145
NATURE WHITE SF/60x60/C/R	NATURE FLOOR	25764	BN-33	60x60x1	3	24,3	145
NATURE WHITE SF/75,5x151/C/R	NATURE FLOOR	25841	BN-118	75,5x151x1	1	26	145
NATURE WHITE SF/90x90/C/R	NATURE FLOOR	25742	BN-48	90x90x1	2	38	145
NATURE WHITE/32x90/R	NATURE WALL	26279	BN-29	32x90x1,05	4	20,9	237
NOAH	MITTE	20175	BN-20	25x75x1,05	7	24,7	235
PALETTE ASH/32x90/R	PALETTE	24402	BN-29	32x90x1,05	4	20,9	239
PALETTE BLUE/32x90/R	PALETTE	24403	BN-29	32x90x1,05	4	20,9	239
PALETTE ECRU/32x90/R	PALETTE	24405	BN-29	32x90x1,05	4	20,9	239
PALETTE FOG/32x90/R	PALETTE	24404	BN-29	32x90x1,05	4	20,9	239
PALETTE GREEN/32x90/R	PALETTE	24407	BN-29	32x90x1,05	4	20,9	239
PALETTE LEAVES COLD/32x90/R	PALETTE	26154	BN-36	32x90x1,05	4	20,9	239
PALETTE LEAVES WARM/32x90/R	PALETTE	26155	BN-36	32x90x1,05	4	20,9	239
PALETTE SQUARE COLD/32x90/R	PALETTE	24493	BN-36	32x90x1,05	4	20,9	239
PALETTE SQUARE WARM/32x90/R	PALETTE	24494	BN-36	32x90x1,05	4	20,9	239
PALETTE TAUPE/32x90/R	PALETTE	24406	BN-29	32x90x1,05	4	20,9	239
PALETTE VOLUTE COLD/32x90/R	PALETTE	26156	BN-36	32x90x1,05	4	20,9	239
PALETTE VOLUTE WARM/32x90/R	PALETTE	26157	BN-36	32x90x1,05	4	20,9	239
PLANET ANTH NT/60x60/R	PLANET	25101	BN-33	60x60x1	3	24,3	149
PLANET ANTH NT/90x90/R	PLANET	25061	BN-48	90x90x1	2	38	149
PLANET ANTH SF/29x90/C/R	PLANET	25009	BN-114	29x90x1	3	19	149
PLANET ANTH SF/30x60/C/R	PLANET	25096	BN-39	30x60x1	6	24,3	149
PLANET ANTH SF/60x120/C/R	PLANET	25177	BN-72	60x120x1	2	33,2	149
PLANET ANTH SF/60x60/C/R	PLANET	25071	BN-33	60x60x1	3	24,3	149
PLANET ANTH SF/75,5x151/C/R	PLANET	26064	BN-118	75,5x151x1	1	28,9	149
PLANET ANTH SF/90x90/C/R	PLANET	25019	BN-48	90x90x1	2	38	149
PLANET ANTH/60x60/A/R	PLANET	25076	BN-88	60x60x1	3	24,3	149
PLANET ANTH/90x90/A/R	PLANET	25056	BN-90	90x90x1	2	38	149
PLANET BONE NT/60x60/R	PLANET	25102	BN-33	60x60x1	3	24,3	149
PLANET BONE NT/90x90/R	PLANET	25062	BN-48	90x90x1	2	38	149
PLANET BONE SF/29x90/C/R	PLANET	25010	BN-114	29x90x1	3	19	149
PLANET BONE SF/30x60/C/R	PLANET	25097	BN-39	30x60x1	6	24,3	149
PLANET BONE SF/60x120/C/R	PLANET	25179	BN-72	60x120x1	2	33,2	149
PLANET BONE SF/60x60/C/R	PLANET	25072	BN-33	60x60x1	3	24,3	149
PLANET BONE SF/75,5x151/C/R	PLANET	26068	BN-118	75,5x151x1	1	26	149
PLANET BONE SF/90x90/C/R	PLANET	25020	BN-48	90x90x1	2	38	149
PLANET BONE/60x60/A/R	PLANET	25077	BN-88	60x60x1	3	24,3	149
PLANET BONE/90x90/A/R	PLANET	25057	BN-90	90x90x1	2	38	149
PLANET MUD NT/60x60/R	PLANET	25104	BN-33	60x60x1	3	24,3	149
PLANET MUD NT/90x90/R	PLANET	25064	BN-48	90x90x1	2	38	149
PLANET MUD SF/29x90/C/R	PLANET	25012	BN-114	29x90x1	3	19	149
PLANET MUD SF/30x60/C/R	PLANET	25099	BN-39	30x60x1	6	24,3	149

Artículo / Article	Serie	Ref.	Tarifa / Price list	Formato / Size	Pzs. caja / Pcs. box	Peso caja / Weight box	P.
PLANET MUD SF/60x120/C/R	PLANET	25178	BN-72	60x120x1	2	33,2	149
PLANET MUD SF/60x60/C/R	PLANET	25074	BN-33	60x60x1	3	24,3	149
PLANET MUD SF/75,5x151/C/R	PLANET	26069	BN-118	75,5x151x1,1	1	28,9	149
PLANET MUD SF/90x90/C/R	PLANET	25022	BN-48	90x90x1	2	38	149
PLANET MUD/60x60/A/R	PLANET	25079	BN-88	60x60x1	3	24,3	149
PLANET MUD/90x90/A/R	PLANET	25059	BN-90	90x90x1	2	38	149
PLANET SILVER NT/60x60/R	PLANET	25105	BN-33	60x60x1	3	24,3	149
PLANET SILVER NT/90x90/R	PLANET	25065	BN-48	90x90x1	2	38	149
PLANET SILVER SF/29x90/C/R	PLANET	25013	BN-114	29x90x1	3	19	149
PLANET SILVER SF/30x60/C/R	PLANET	25100	BN-39	30x60x1	6	24,3	149
PLANET SILVER SF/60x120/C/R	PLANET	25180	BN-72	60x120x1	2	33,2	149
PLANET SILVER SF/60x60/C/R	PLANET	25075	BN-33	60x60x1	3	24,3	149
PLANET SILVER SF/75,5x151/C/R	PLANET	26065	BN-118	75,5x151x1	1	26	149
PLANET SILVER SF/90x90/C/R	PLANET	25023	BN-48	90x90x1	2	38	149
PLANET SILVER/60x60/A/R	PLANET	25080	BN-88	60x60x1	3	24,3	149
PLANET SILVER/90x90/A/R	PLANET	25060	BN-90	90x90x1	2	38	149
PLANET WHITE NT/60x60/R	PLANET	25780	BN-33	60x60x1	3	24,3	149
PLANET WHITE NT/90x90/R	PLANET	25776	BN-48	90x90x1	2	38	149
PLANET WHITE SF/29x90/C/R	PLANET	25812	BN-114	29x90x1	3	19	149
PLANET WHITE SF/30x60/C/R	PLANET	25187	BN-39	30x60x1	6	24,3	149
PLANET WHITE SF/60x120/C/R	PLANET	25181	BN-72	60x120x1	2	33,2	149
PLANET WHITE SF/60x60/C/R	PLANET	25190	BN-33	60x60x1	3	24,3	149
PLANET WHITE SF/75,5x151/C/R	PLANET	26066	BN-118	75,5x151x1	1	26	149
PLANET WHITE SF/90x90/C/R	PLANET	25774	BN-48	90x90x1	2	38	149
PURE DECOR ALEX WHITE	PURE	21787	BN-20	25x75x1,05	7	24,7	243
PURE DECOR SMITH WHITE	PURE	21788	BN-20	25x75x1,05	7	24,7	243
PURE STRIPED/100/R	PURE	23169	BN-66	33,3x100x0,75	6	24,9	243
PURE WHITE/25x75	PURE	21786	BN-16	25x75x1,05	7	24,7	243
PURE-W/100/R	PURE	20586	BN-65	33,3x100x0,75	6	24,9	243
PURE-W/90/R	PURE	16159	BN-29	32x90x1,05	4	20,9	243
PURE-W/91	PURE	16150	BN-21	33x91x1,05	4	21,8	243
RHOM.NATURE ANTH SF/14.8x17/C/R	NATURE FLOOR	26186	P-17	ROM_14,8x17x1	16	11,4	145
RHOM.NATURE BEIGE SF/14.8x17/C/R	NATURE FLOOR	26187	P-17	ROM_14,8x17x1	16	11,4	145
RHOM.NATURE GREY SF/14.8x17/C/R	NATURE FLOOR	26188	P-17	ROM_14,8x17x1	16	11,4	145
RHOM.NATURE WHITE SF/14.8x17/C/R	NATURE FLOOR	26189	P-17	ROM_14,8x17x1	16	11,4	145
SALINES BONE/100/R	SALINES	23136	BN-65	33,3x100x0,75	6	24,9	251
SALINES DECOR BONE/100/R	SALINES	23144	BN-66	33,3x100x0,75	6	24,9	251
SALINES DECOR SILVER/100/R	SALINES	23146	BN-66	33,3x100x0,75	6	24,9	251
SALINES DECOR WHITE/100/R	SALINES	23145	BN-66	33,3x100x0,75	6	24,9	251
SALINES SILVER/100/R	SALINES	23143	BN-65	33,3x100x0,75	6	24,9	251
SALINES WAVES BONE/33,3x100/R	SALINES	31188	BN-66	33,3x100x0,86	5	22,5	251
SALINES WAVES SILVER/33,3x100/R	SALINES	31190	BN-66	33,3x100x0,86	5	22,5	251
SALINES WAVES WHITE/33,3x100/R	SALINES	31189	BN-66	33,3x100x0,86	5	22,5	251
SALINES WHITE/100/R	SALINES	23142	BN-65	33,3x100x0,75	6	24,9	251
SATYA-B/90x90/A/R	SATYA	25445	BN-90	90x90x1	2	38	153
SATYA-B/90x90/R	SATYA	25442	BN-48	90x90x1	2	38	153
SATYA-G/90x90/A/R	SATYA	25446	BN-90	90x90x1	2	38	153
SATYA-G/90x90/R	SATYA	25443	BN-48	90x90x1	2	38	153
SATYA-H/90x90/A/R	SATYA	25447	BN-90	90x90x1	2	38	153
SATYA-H/90x90/R	SATYA	25444	BN-48	90x90x1	2	38	153
SHARK-B/60x60/L/R	SHARK	25524	BN-38	60x60x1	3	24,3	155
SHARK-B/60x60/R	SHARK	25527	BN-33	60x60x1	3	24,3	155

Artículo / Article	Serie	Ref.	Tarifa / Price list	Formato / Size	Pzs. caja / Pcs. box	Peso caja / Weight box	P.
SHARK-B/90x90/L/R	SHARK	25534	BN-42	90x90x1	2	38	155
SHARK-B/90x90/R	SHARK	25531	BN-48	90x90x1	2	38	155
SHARK-N/60x60/L/R	SHARK	25526	BN-38	60x60x1	3	24,3	155
SHARK-N/60x60/R	SHARK	25529	BN-33	60x60x1	3	24,3	155
SHARK-N/90x90/L/R	SHARK	25536	BN-42	90x90x1	2	38	155
SHARK-N/90x90/R	SHARK	25533	BN-48	90x90x1	2	38	155
SHARK-S/60x60/L/R	SHARK	25525	BN-38	60x60x1	3	24,3	155
SHARK-S/60x60/R	SHARK	25528	BN-33	60x60x1	3	24,3	155
SHARK-S/90x90/L/R	SHARK	25535	BN-42	90x90x1	2	38	155
SHARK-S/90x90/R	SHARK	25532	BN-48	90x90x1	2	38	155
SPICATTO-G	VIBRATO	19355	BN-20	25x75x1,05	7	22,8	259
SPICATTO-H	VIBRATO	19259	BN-20	25x75x1,05	7	22,8	259
T.BARCELOS/19,5/R	MUMBLE	25371	P-23	19,5x19,5x1	9	9,5	137
T.FS FAENZA-A	FS FAENZA	13717	P-6	11x11x0,95	24	5,7	285
T.FS FAENZA-N	FS FAENZA	13719	P-6	11x11x0,95	24	5,7	285
T.FS MANISES-B	FS FAENZA	13720	P-6	11x11x0,95	24	5,7	285
T.GROVE-G/19,5/R	GROVE	25494	P-23	19,5x19,5x1	9	9,5	105
T.GROVE-H/19,5/R	GROVE	25493	P-23	19,5x19,5x1	9	9,5	105
T.HV-12	HOUSE OF VANITY	14685	P-6	11x11x0,83	24	4,8	111
T.HV-34	HOUSE OF VANITY	14686	P-6	11x11x0,83	24	5	111
T.OXIK/19,5/R	MUMBLE	25372	P-23	19,5x19,5x1	9	9,5	137
TREMOLO-G	VIBRATO	19354	BN-20	25x75x1,05	7	22,8	259
TREMOLO-H	VIBRATO	19258	BN-20	25x75x1,05	7	22,8	259
TRI.PLANET ANTH SF/29x8/C/R	PLANET	22485	P-15	29x8x1	15	2,9	149
TRI.PLANET BONE SF/29x8/C/R	PLANET	22486	P-15	29x8x1	15	2,9	149
TRI.PLANET GREY SF/29x8/C/R	PLANET	22487	P-15	29x8x1	15	2,9	149
TRI.PLANET MUD SF/29x8/C/R	PLANET	22488	P-15	29x8x1	15	2,9	149
TRI.PLANET SILVER SF/29x8/C/R	PLANET	22489	P-15	29x8x1	15	2,9	149
TRI.PLANET WHITE SF/29x8/C/R	PLANET	25798	P-15	29x8x1	15	2,9	149
TYCHO-W	FROZEN	19397	BN-25	33x91x1,05	4	21,8	193
TYCHO-W/R	FROZEN	19868	BN-36	32x90x1,05	4	20,9	193
UNIQUE/15x90/R	UNIQUE	25646	BN-27	15x90x1	7	21,7	157
UNIQUE/19,5x121,5/R	UNIQUE	25645	BN-2	19,5x121,5x1	4	22,2	157
VERBIER ASH AS/19,5x121,5/C/R	VERBIER	32079	BN-95	19,5x121,5x1	4	22,2	159
VERBIER ASH AS/24x151/C/R	VERBIER	31730	BN-121	24x151x1	3	24,3	159
VERBIER CHERRY AS/19,5x121,5/C/R	VERBIER	32080	BN-95	19,5x121,5x1	4	22,2	159
VERBIER CHERRY AS/24x151/C/R	VERBIER	31599	BN-121	24x151x1	3	24,3	159
VERBIER CIGAR AS/19,5x121,5/C/R	VERBIER	32081	BN-95	19,5x121,5x1	4	22,2	159
VERBIER CIGAR AS/24x151/C/R	VERBIER	31601	BN-121	24x151x1	3	24,3	159
VERBIER HONEY							

Porcelain Tiles

46

White Body Tiles

168

FS Vintage Tiles

266

ADDITIONAL INFORMATION

384

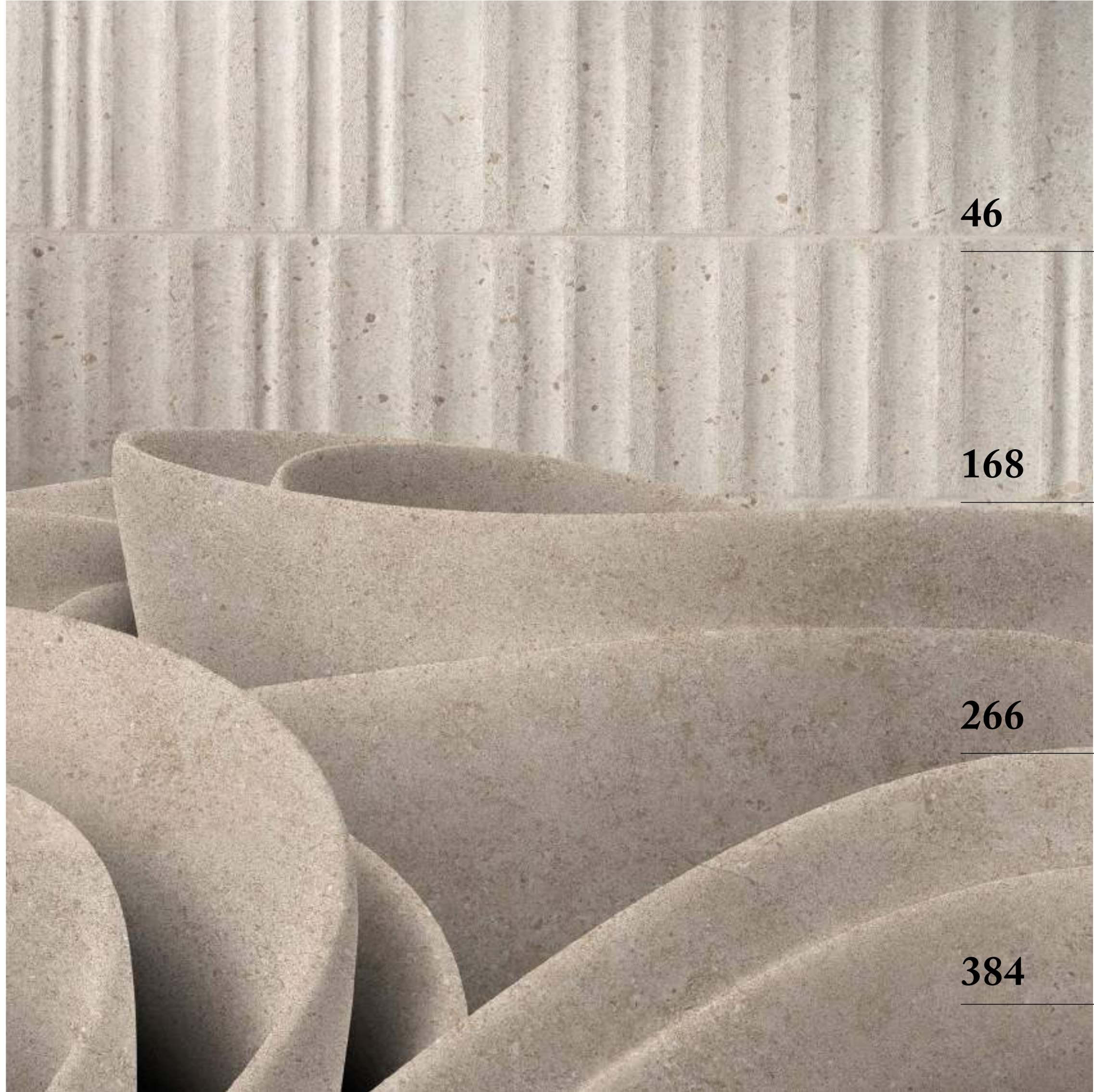

PORCELAIN

tiles

ALLEY 4D	49
ALPINE 4D	53
ASPEN	57
BRASS	59
CLUNY 4D	61
CLUNY floor	69
DOWNTOWN 4D	73
DOWNTOWN floor	77
ESSENCE	79
GHENT 4D	81
GHENT floor	87
GRANIER floor	91
GROUND 4D	97
GROVE	105
GRUNGE floor	107
HOUSE OF VANITY	111
LENK	113
LUCCA 4D	117
LUCCA floor	123
MANHATTAN 4D	127
MANHATTAN floor	133
MUMBLE	137
MYSTIC 4D	141
NATURE floor	145
PLANET	149
SATYA	153
SHARK	155
UNIQUE	157
VERBIER floor	159
WHISTLER	165



Alley Grey_100*100
Alley Grey_100*100 BH

Alley 4D



White



Bone



Grey



Anthracite

ALLEY 4D

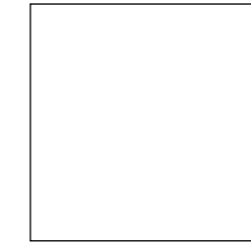

100 * 100 * 0,8 cm | 39 * 39"

RECTIFIED	NATURAL		ANTISLIP BUSH HAMMERED	
	BN94	BN110	BN99	BN112
WHITE	-	23396	-	23401
BONE	23398	-	23403	-
GREY	23397	-	23402	-
ANTHRACITE	23400		23405	

D. ALLEY MOSAIC

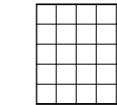

25 * 25 cm | 10 * 10"

NO RECTIFIED	NATURAL	ANTISLIP BUSH HAMMERED
	P39	P39
WHITE	23485	23491
BONE	23482	23487
GREY	23483	23489
ANTHRACITE	23481	23488

D. ALLEY BRICK

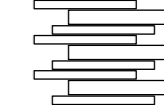

29,8 * 29,2 cm | 12 * 12"

NO RECTIFIED	NATURAL
	P50
WHITE	23497
BONE	23494
GREY	23495
ANTHRACITE	23493



22303 ALUMINIO/100/MAT _ 100 * 0,5 cm | 39 * 0,2" _ P42



26153 L. GOLDEN/MAT/100 _ 100 * 0,5 cm | 39 * 0,2" _ P42

CARACTERÍSTICAS TÉCNICAS | TECHNICAL CHARACTERISTICS

joint	frost proof	versatile	matt	full body	different shades	shade variation	various graphics	thickness

CARACTERÍSTICAS TÉCNICAS ANTIDESLIZAMIENTO | ANTI-SLIP CHARACTERISTICS

Ensayo Essay	Características Features	Resultado Result	
		NATURAL	ANTISLIP BUSH HAMMERED
DIN 51130	Ángulo crítico (Pies calzados) Critical angle (footwear)	R9	R11
DIN 51097	Ángulo crítico (Pies descalzos) Critical angle (Wet loaded barefoot)	-	A+B+C
BS 7976-2	Antideslizamiento (Test del péndulo) Slip resistance (Pendulum test-PTV)	-	+36 Wet
UNE 41901 EX	Antideslizamiento (Test del péndulo) Slip resistance (Pendulum test)	Class 1	Class 3
ANSI A137.1	Coefficiente de Fricción Dinámico Dynamic Coefficient of Friction (DCOF)	>0,42	>0,42
ISO 10545-6	Resistencia a la Abrasión Profunda Resistance to Deep Abrasion	< 175 mm3	< 175 mm3



COMPLEMENTARY PIECE



PIECE POOL



PACKING

+ INFO | Pag. 260

Alley 4D



Alpine Beige SP
_100*180

Alpine 4D

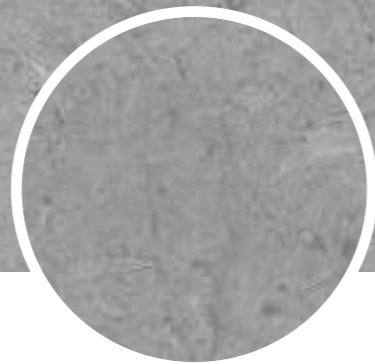

Alpine Grey SP
_100*180

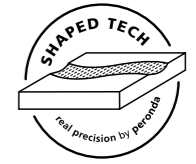

White



Beige

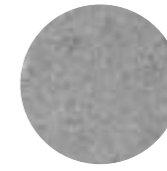

Grey



Anthracite

ALPINE

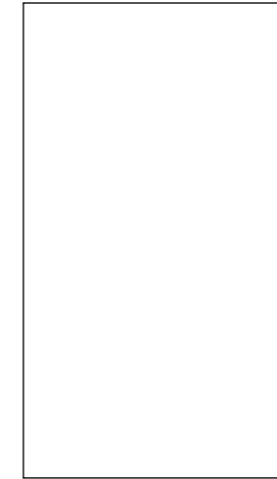

100 * 180 * 0,8 cm | 39 * 71"

RECTIFIED	SHAPED	
	BN137	BN138
ANTHRACITE	28519	
BEIGE	28520	
GREY	28522	
WHITE	28521	

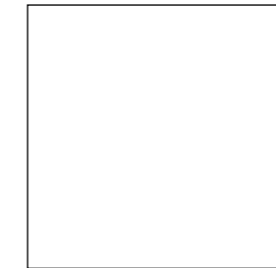

100 * 100 * 0,8 cm | 39 * 39"

RECTIFIED	SHAPED	
	BN135	BN136
ANTHRACITE	28948	
BEIGE	28946	
GREY	28947	
WHITE	28945	

ALPINE DECOR



100 * 180 * 0,8 cm | 39 * 71"

RECTIFIED	SHAPED	
	BN139	BN140
ANTHRACITE	29035	
BEIGE	29033	
GREY	29034	
WHITE	29036	

CARACTERÍSTICAS TÉCNICAS | TECHNICAL CHARACTERISTICS

joint	frost proof	versatile	matt	full body	different shades	shade variation	various graphics	thickness

CARACTERÍSTICAS TÉCNICAS ANTIDESLIZAMIENTO | ANTI-SLIP CHARACTERISTICS

Ensayo Essay	Características Features	Resultado Result
UNE 41901 EX	Antideslizamiento (Test del péndulo) Slip resistance (Pendulum test)	SHAPED 4D Class 1
ANSI A137.1	Coefficiente de Fricción Dinámico Dynamic Coefficient of Friction (DCOF)	>0,42
ISO 10545-6	Resistencia a la Abrasión Profunda Resistance to Deep Abrasion	< 175 mm3



+ INFO | Pag. 260

Alpine 4D



Ash



Sand



Camel



Smoke

ASPEN



45 patterns

19,5 * 121,5 * 1 cm | 8 * 48"

RECTIFIED	NATURAL	ANTISLIP
	BN60	BN95
ASH	24958	-
SAND	24959	-
CAMEL	24957	24961
SMOKE	24960	24962

CARACTERÍSTICAS TÉCNICAS | TECHNICAL CHARACTERISTICS

joint	frost proof	versatile	matt	different shades	shade variation	various graphics	various moulds

CARACTERÍSTICAS TÉCNICAS ANTIDESLIZAMIENTO | ANTI-SLIP CHARACTERISTICS

Ensayo Essay	Características Features	Resultado Result	
		NATURAL	ANTISLIP
DIN 51130	Ángulo crítico (Pies calzados) Critical angle (footwear)	R9	R11
DIN 51097	Ángulo crítico (Pies descalzos) Critical angle (Wet loaded barefoot)	-	A+B
BS-7976-2	Antideslizamiento (Test del péndulo) Slip resistance (Pendulum test-PTV)	-	+36 Wet
UNE-41901 EX	Antideslizamiento (Test del péndulo) Slip resistance (Pendulum test)	Class 1	Class 3
ANSI A137.1	Coefficiente de Fricción Dinámico Dynamic Coefficient of Friction (DCOF)	> 0,42	> 0,42
ISO 10545-7	Resistencia a la Abrasión Superficial/Resistance to Surface Abrasion	PEI 4	PEI 4



+ INFO | Pag. 260

Aspen



Brass Oxide
L_60*120

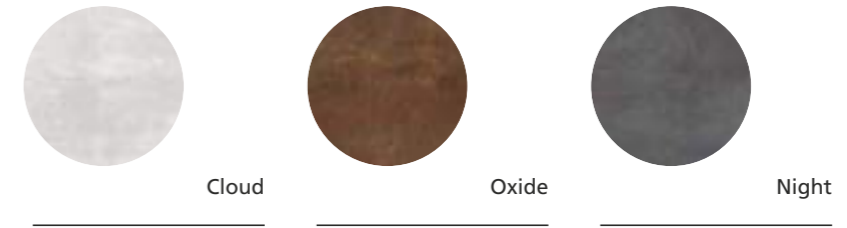

BRASS

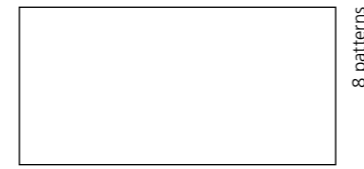

8 patterns

60 * 120 * 1 cm | 24 * 48"

RECTIFIED	NATURAL BN72	LAPATTO BN86
CLOUD	25597	25594
OXIDE	25599	25596
NIGHT	25598	25595

D. BRAZEN

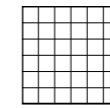

30 * 30 cm | 12 * 12"

NO RECTIFIED	NATURAL P45
CLOUD	21331
OXIDE	21333
NIGHT	21332

CARACTERÍSTICAS TÉCNICAS | TECHNICAL CHARACTERISTICS

joint	frost proof	versatile	different shades	shade variation	various graphics	matt	* gloss

* acabado lapatto | lapatto finish

CARACTERÍSTICAS TÉCNICAS ANTIDESLIZAMIENTO | ANTI-SLIP CHARACTERISTICS

Ensayo Essay	Características Features	Resultado Result	
		NATURAL	LAPATTO
DIN 51130	Ángulo crítico (Pies calzados) Critical angle (footwear)	R10	R9
DIN 51097	Ángulo crítico (Pies descalzos) Critical angle (Wet loaded barefoot)	A+B	-
BS 7976-2	Antideslizamiento (Test del péndulo) Slip resistance (Pendulum test-PTV)	+36 Wet	-
UNE 41901 EX	Antideslizamiento (Test del péndulo) Slip resistance (Pendulum test)	Class 2	Class 1
ANSI A137.1	Coefficiente de Fricción Dinámico Dynamic Coefficient of Friction (DCOF)	> 0,42	-
ISO 10545-7	Resistencia a la Abrasión Superficial Resistance to Surface Abrasion	PEI 4	PEI 4



+ INFO | Pag. 260

Brass



Cluny White
SP_100x275



Sand SP_100x100
Sand_100x100 A

Cluny 4D



Cluny Silver SP
_100*100

Cluny 4D



Cluny White
SP_100*275



Cluny Beige
SP_100*100



Cluny Silver SP_100*275
Silver SP_100*100

Cluny 4D



Cluny White SP_100x275 · White_100x100 A · White Rej. · Ang. Rej. · P.V. · Ang. P.V.



Cluny Sand_100x100x2. A

MATCHING WALL COLLECTIONS
CLUNY_WHITE BODY | Pag. 171

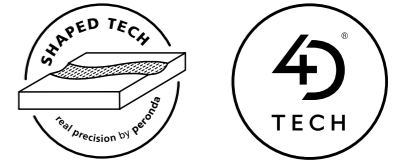

White



Sand



Beige

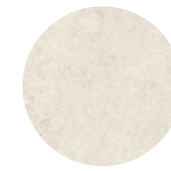

Silver

CLUNY 4D



5 patterns

100 * 275 * 0,6 cm
39 * 108"

RECTIFIED	SHAPED	
	BN141	BN142
BEIGE	36282	
SAND	36281	
SILVER	36283	
WHITE	36280	

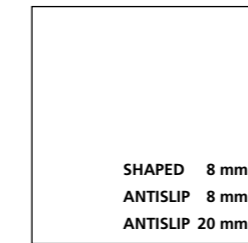

12 patterns

100 * 100 * 0,8 cm
39 * 39"

RECTIFIED	SHAPED		ANTISLIP		ANTISLIP 20mm
	BN135	BN136	BN144	BN143	BN145
BEIGE	36337		36341		36348
SAND	36338		36343		36350
SILVER	36339		36342		36349
WHITE	36336		36340		36347

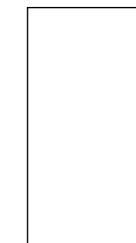

24 patterns

50 * 100 * 2 cm
20 * 39"

RECTIFIED	ANTISLIP 20mm
	BN147
BEIGE	36902
SAND	36903
SILVER	36904
WHITE	36905

CARACTERÍSTICAS TÉCNICAS
TECHNICAL CHARACTERISTICS

joint	frost proof	versatile	matt
different shades	shade variation	various graphics	various moulds

CARACTERÍSTICAS TÉCNICAS ANTIDESLIZAMIENTO | ANTI-SLIP CHARACTERISTICS

Ensayo Essay	Características Features	Resultado Result	
		SHAPED	ANTISLIP
DIN 51130	Ángulo crítico (Pies calzados) Critical angle (footwear)	-	R11
DIN 51097	Ángulo crítico (Pies descalzos) Critical angle (Wet loaded barefoot)	-	A+B+C
BS 7976-2	Antideslizamiento (Test del péndulo) Slip resistance (Pendulum test-PTV)	-	+36 Wet
UNE 41901 EX	Antideslizamiento (Test del péndulo) Slip resistance (Pendulum test)	Class 1	Class 3
AINSI A137.1	Coefficiente de Fricción Dinámico Dynamic Coefficient of Friction (DCOF)	-	> 0,42
ISO 10545-6	Resistencia a la Abrasión Profunda Resistance to Deep Abrasion	< 175 mm3	< 175 mm3



+ INFO | Pag. 260

Cluny 4D

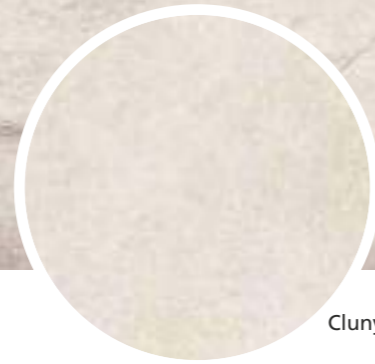

Cluny Silver SP_100x275
Silver AS_90x90

Cluny floor



Cluny Silver
AS_90x90

MATCHING WALL COLLECTIONS
CLUNY_WHITE BODY | Pag. 171

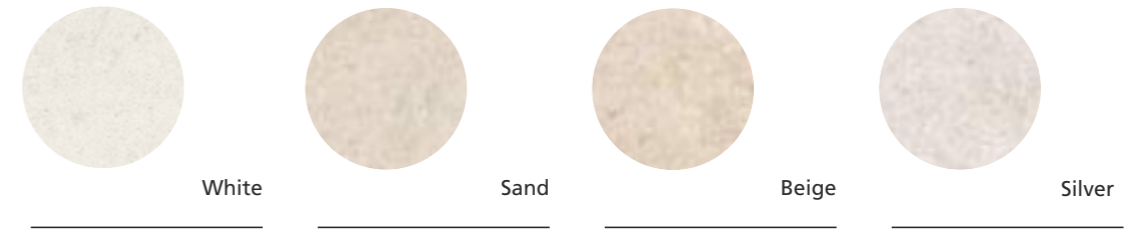

CLUNY floor

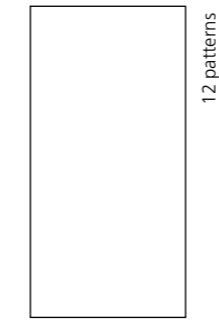

60 * 120 * 1 cm | 24 * 48"

RECTIFIED	ALL IN ONE
	BN116
BEIGE	36356
SAND	36358
SILVER	36357
WHITE	36355



90 * 90 * 1 cm | 36 * 36"

RECTIFIED	ALL IN ONE	SOFT
	BN90	BN48
BEIGE	36354	36360
SAND	36353	36362
SILVER	36352	36361
WHITE	36351	36359

CARACTERÍSTICAS TÉCNICAS | TECHNICAL CHARACTERISTICS

joint	frost proof	versatile	matt	full body	different shades	shade variation	various graphics

CARACTERÍSTICAS TÉCNICAS ANTIDESLIZAMIENTO | ANTI-SLIP CHARACTERISTICS

Ensayo Essay	Características Features	ALL IN ONE
DIN 51130	Ángulo crítico (Pies calzados) Critical angle (footwear)	R11
DIN 51097	Ángulo crítico (Pies descalzados) Critical angle (Wet loaded barefoot)	A+B+C
BS 7976-2	Antideslizamiento (Test del péndulo) Slip resistance (Pendulum test-PTV)	+36 Wet
UNE 41901 EX	Antideslizamiento (Test del péndulo) Slip resistance (Pendulum test)	Class 3
ANSI A137.1	Coefficiente de Fricción Dinámico Dynamic Coefficient of Friction (DCOF)	> 0,42
ISO 10545-6	Resistencia a la Abrasión Profunda Resistance to Deep Abrasion	< 175 mm3



+ INFO | Pag. 260

Cluny floor

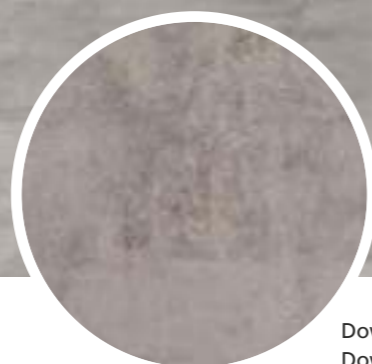

Downtown Grey_100*180
Downtown Grey_100*100

Downtown 4D



Downtown Grey_100*100

MATCHING WALL COLLECTIONS
DOWNTOWN_WHITE BODY | Pag. 185

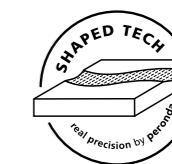

White



Beige



Grey



Anthracite

DOWNTOWN 4D

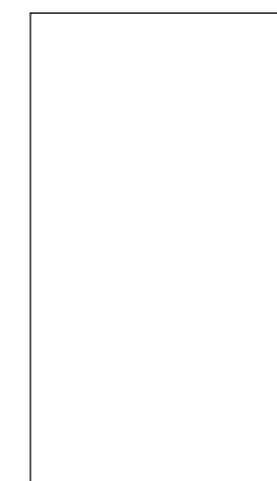

8 patterns

100 * 180 * 0,6 cm | 39 * 71"

RECTIFIED	SHAPED	
	BN137	BN138
ANTHRACITE	31345	
BEIGE	31346	
GREY	31348	
WHITE		31347

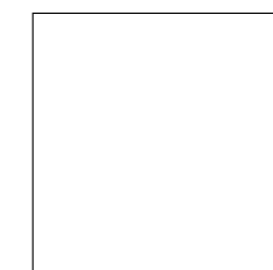

13 patterns

100 * 100 * 0,6 cm | 39 * 39"

RECTIFIED	SHAPED	
	BN135	BN136
ANTHRACITE	31012	
BEIGE	31013	
GREY	31014	
WHITE		31015

CARACTERÍSTICAS TÉCNICAS | TECHNICAL CHARACTERISTICS

joint	frost proof	versatile	matt	full body	different shades	shade variation	various graphics	thickness

CARACTERÍSTICAS TÉCNICAS ANTIDESLIZAMIENTO | ANTI-SLIP CHARACTERISTICS

Ensayo Essay	Características Features	Resultado Result
UNE 41901 EX	Antideslizamiento (Test del péndulo) Slip resistance (Pendulum test)	Class 1
ANSI A137.1	Coefficiente de Fricción Dinámico Dynamic Coefficient of Friction (DCOF)	> 0,42
ISO 10545-6	Resistencia a la Abrasión Profunda Resistance to Deep Abrasion	< 175 mm3

100 * 180 cm 39 * 71"
SHAPED
WALLPE3C2



COMPLEMENTARY
PIECE



PIECE POOL



PACKING

+ INFO | Pag. 260

Downtown 4D



Downtown Beige
SP_100*100

MATCHING WALL COLLECTIONS
DOWNTOWN_WHITE BODY | Pag. 185



White



Beige



Grey



Anthracite

DOWNTOWN

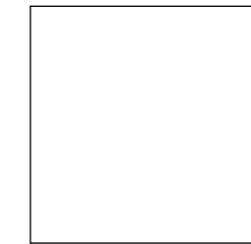

13 patterns

90 * 90 * 1 cm | 36 * 36"

RECTIFIED	SHAPED	ANTISLIP
	BN7	BN90
ANTHRACITE	29713	30733
BEIGE	29714	30738
GREY	29715	30740
WHITE	29716	30739

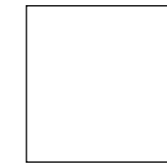

26 patterns

60 * 60 * 1 cm | 24 * 24"

RECTIFIED	NATURAL
	BN33
ANTHRACITE	29698
BEIGE	29700
GREY	29699
WHITE	29689



21 patterns

60 * 120 * 1 cm | 24 * 48"

RECTIFIED	SHAPED
	BN6
ANTHRACITE	29695
BEIGE	29696
GREY	29697
WHITE	29694

CARACTERÍSTICAS TÉCNICAS | TECHNICAL CHARACTERISTICS

joint	frost proof	versatile	matt	full body	different shades	shade variation	various graphics

CARACTERÍSTICAS TÉCNICAS ANTIDESLIZAMIENTO | ANTI-SLIP CHARACTERISTICS

Ensayo Essay	Características Features	Resultado Result		
		SHAPED	NATURAL	ANTISLIP
DIN 51130	Ángulo crítico (Pies calzados) Critical angle (footwear)	R10	R10	R11
DIN 51097	Ángulo crítico (Pies descalzados) Critical angle (Wet loaded barefoot)	A+B	A+B	A+B+C
BS 7976-2	Antideslizamiento (Test del péndulo) Slip resistance (Pendulum test-PTV)	+36 Wet	+36 Wet	+36 Wet
UNE 41901 EX	Antideslizamiento (Test del péndulo) Slip resistance (Pendulum test)	Class 2	Class 2	Class 3
ANSI A137.1	Coefficiente de Fricción Dinámico Dynamic Coefficient of Friction (DCOF)	> 0,42	> 0,42	> 0,42
ISO 10545-6	Resistencia a la Abrasión Profunda Resistance to Deep Abrasion	< 175 mm3	< 175 mm3	< 175 mm3



+ INFO | Pag. 260

Downtown floor



Essence Almond_24 Essence Almond_19,5



Essence Taupe_19,5



Maple



Almond



Taupe



Nut

ESSENCE



36 patterns

24 * 151 * 1 cm | 10 * 59"

RECTIFIED	NATURAL
	BN93
MAPLE	-
ALMOND	22329
TAUPE	22330
NUT	-



60 patterns

19,5 * 121,5 * 1 cm | 8 * 48"

RECTIFIED	NATURAL	ANTISLIP
	BN60	BN95
MAPLE	25637	-
ALMOND	25635	25636
TAUPE	25639	25640
NUT	25638	-

CARACTERÍSTICAS TÉCNICAS | TECHNICAL CHARACTERISTICS

joint	frost proof	versatile	matt	different shades	shade variation	various graphics	various moulds

CARACTERÍSTICAS TÉCNICAS ANTIDESLIZAMIENTO | ANTI-SLIP CHARACTERISTICS

Ensayo Essay	Características Features	Resultado Result	
		NATURAL	ANTISLIP
DIN 51130	Ángulo crítico (Pies calzados) Critical angle (footwear)	R9	R11
DIN 51097	Ángulo crítico (Pies descalzos) Critical angle (Wet loaded barefoot)	-	A+B
BS 7976-2	Antideslizamiento (Test del péndulo) Slip resistance (Pendulum test-PTV)	-	+36 Wet
UNE 41901 EX	Antideslizamiento (Test del péndulo) Slip resistance (Pendulum test)	Class 1	Class 3
AINSI A137.1	Coefficiente de Fricción Dinámico Dynamic Coefficient of Friction (DCOF)	> 0,42	> 0,42
ISO 10545-7	Resistencia a la Abrasión Superficial Resistance to Surface Abrasion	PEI 4	PEI 4



COMPLEMENTARY PIECE



PIECE POOL



PACKING

+ INFO | Pag. 260

Essence

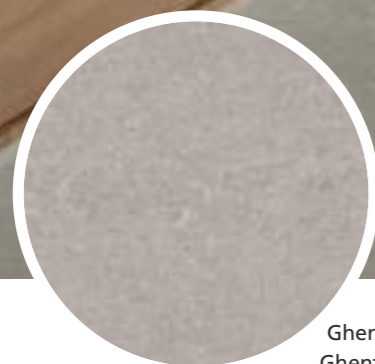

Gkent Grey_100*275 SP
Gkent Silver_100*100 SP



Gkent
White_100*275 SP

Gkent 4D



Ghent Beige
SP_100*275



Ghent White
SP_100*100



Ghent
Silver_100*275 SP

Ghent 4D



Ghent White SP_100*275 White A_100*100*2 Ghent Beige SP_100*100



Ghent Beige SP_100*275 Ghent Beige A_100*100*2 Ghent Beige A_50*100*2

MATCHING WALL COLLECTIONS
GHENT_WHITE BODY | Pag. 197

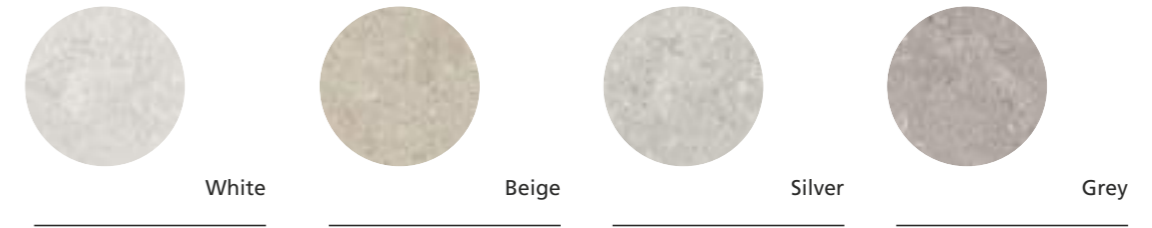
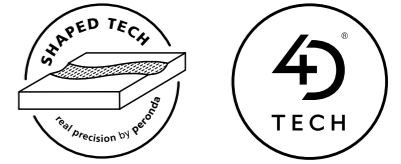

GHENT 4D

100 * 275 * 0,6 cm 39 * 108"	100 * 180 * 0,8 cm 39 * 71"	100 * 100 * 0,8 cm 39 * 39"	100 * 100 * 2 cm 39 * 39"	50 * 100 * 2 cm 20 * 39"
RECTIFIED SHAPED BN141 BN142	RECTIFIED SHAPED BN137 BN138	RECTIFIED SHAPED ANTISLIP ANTISLIP 20mm BN135 BN136 BN144 BN143 BN145	ANTISLIP ANTISLIP 20mm BN144 BN143 BN145	ANTISLIP 20mm BN147
BEIGE 35597 GREY 35598 SILVER 35599 WHITE 35600	BEIGE 33200 GREY 33202 SILVER 33201 WHITE 33203	BEIGE 31747 GREY 31749 SILVER 31748 WHITE 31746	33948 34878 33947 34734 33946 34733 33945 34732	35567 35568 35569 35570

CARACTERÍSTICAS TÉCNICAS
TECHNICAL CHARACTERISTICS

joint	frost proof	versatile	matt	full body
different shades	shade variation	various graphics	thickness	

CARACTERÍSTICAS TÉCNICAS ANTIDESLIZAMIENTO | ANTI-SLIP CHARACTERISTICS

Ensayo Essay	Características Features	Resultado Result	
		SHAPED	ANTISLIP
DIN 51130	Ángulo crítico (Pies calzados) Critical angle (footwear)	-	R11
DIN 51097	Ángulo crítico (Pies descalzos) Critical angle (Wet loaded barefoot)	-	A+B+C
BS 7976-2	Antideslizamiento (Test del péndulo) Slip resistance (Pendulum test-PTV)	-	+36 Wet
UNE 41901 EX	Antideslizamiento (Test del péndulo) Slip resistance (Pendulum test)	Class 1	Class 3
AINSI A137.1	Coefficiente de Fricción Dinámico Dynamic Coefficient of Friction (DCOF)	-	> 0,42
ISO 10545-6	Resistencia a la abrasión profunda Resistance to Deep Abrasion	< 175 mm3	< 175 mm3

COMPLEMENTARY PIECE
 PIECE POOL
 PACKING
 + INFO | Pag. 260

Ghent 4D



Ghent White_100*275 SP
Ghent White_90*90 AS

Ghent floor



Ghent Silver_33,3*100 SP Ghent Decor Silver_33,3*100 SP Ghent Silver_90*90 AS





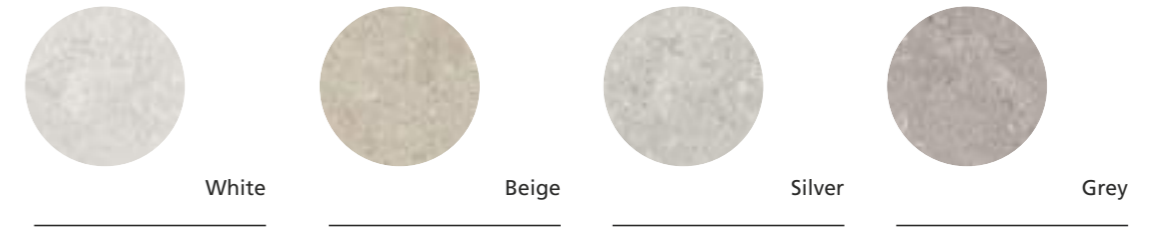

Ghent Grey AS_90*90

MATCHING WALL COLLECTIONS
GHENT_WHITE BODY | Pag. 197

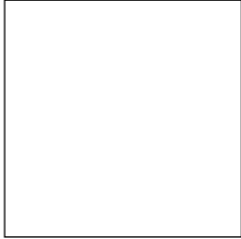
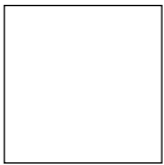

GHENT FLOOR

									
12 patterns	20 patterns	10 patterns	D. GHENT MOSAIC16T	D. GHENT MOSAIC12T					
90 * 90 * 1 cm 36 * 36"	60 * 60 * 1 cm 24 * 24"	60 * 120 * 1 cm 24 * 48"	30 * 30 * 1 cm 12 * 12"	30 * 30 * 1 cm 12 * 12"					
RECTIFIED	ALL IN ONE	RECTIFIED	NATURAL	RECTIFIED	ALL IN ONE	RECTIFIED	ALL IN ONE	RECTIFIED	ALL IN ONE
	BN90		BN33		BN116		P36		P36
BEIGE	31891	BEIGE	31755	BEIGE	31753	BEIGE	32099	BEIGE	32103
GREY	31892	GREY	31756	GREY	31751	GREY	32100	GREY	32104
SILVER	31893	SILVER	31757	SILVER	31752	SILVER	32101	SILVER	32105
WHITE	31894	WHITE	31754	WHITE	31750	WHITE	32102	WHITE	32106

CARACTERÍSTICAS TÉCNICAS | TECHNICAL CHARACTERISTICS

joint	frost proof	versatile	matt	full body	different shades	shade variation	various graphics
							

CARACTERÍSTICAS TÉCNICAS ANTIDESLIZAMIENTO | ANTI-SLIP CHARACTERISTICS

Ensayo Essay	Características Features	ALL IN ONE	NATURAL
DIN 51130	Ángulo crítico (Pies calzados) Critical angle (footwear)	R11	R10
DIN 51097	Ángulo crítico (Pies descalzados) Critical angle (Wet loaded barefoot)	A+B+C	A+B
BS 7976-2	Antideslizamiento (Test del péndulo) Slip resistance (Pendulum test-PTV)	+36 Wet	+36 Wet
UNE-ENV 12633	Antideslizamiento (Test del péndulo) Slip resistance (Pendulum test)	Class 3	Class 2
ANSI A137.1	Coefficiente de Fricción Dinámico Dynamic Coefficient of Friction (DCOF)	> 0,42	> 0,42

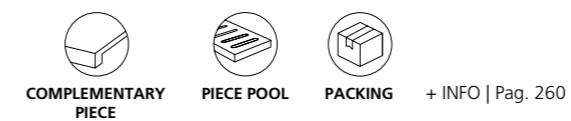

Ghent floor



Granier Taupe
AS_24*151

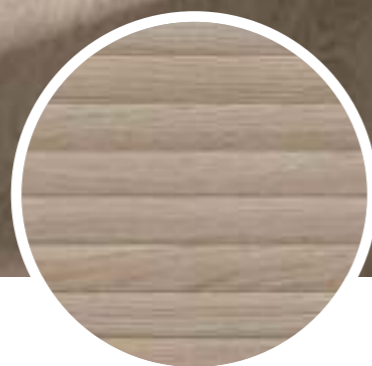

Granier Taupe
Decor SP_33,3x100

Granier floor



Granier Ash AS_24*151 Manhattan Silver Lines_33,3x100



Granier Maple AS_24*151 Manhattan White_33,3x100



Granier Taupe
AS_24*151

Granier floor



Granier Honey AS_24 * 151



Granier Natural AS_24 * 151

MATCHING WALL COLLECTIONS
GRANIER_WHITE BODY | Pag. 201

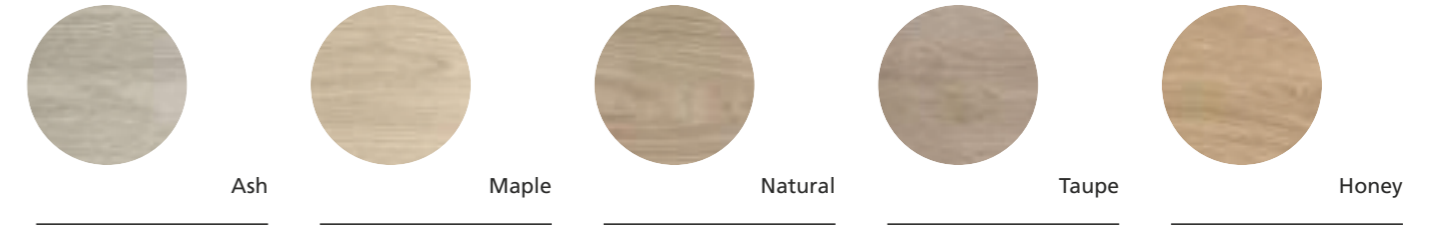

GRANIER



24 * 151 * 1 cm | 9 * 59"

RECTIFIED	ALL IN ONE
	BN121
ASH	34641
HONEY	34637
MAPLE	34639
NATURAL	34638
TAUPE	34640

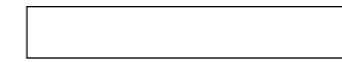

19,5*121,5*1 cm | 8*48"

RECTIFIED	ALL IN ONE
	BN95
ASH	34764
HONEY	34765
MAPLE	34766
NATURAL	34767
TAUPE	34768

CARACTERÍSTICAS TÉCNICAS | TECHNICAL CHARACTERISTICS

joint	frost proof	versatile	matt	varios moulds	different shades	shade variation	various graphics

CARACTERÍSTICAS TÉCNICAS ANTIDESLIZAMIENTO | ANTI-SLIP CHARACTERISTICS

Ensayo Essay	Características Features	Resultado Result
		ALL IN ONE
DIN 51130	Ángulo crítico (Pies calzados) Critical angle (footwear)	R11
DIN 51097	Ángulo crítico (Pies descalzos) Critical angle (Wet loaded barefoot)	A+B+C
BS-7976-2	Antideslizamiento (Test del péndulo) Slip resistance (Pendulum test-PTV)	+36 Wet
UNE-41901 EX	Antideslizamiento (Test del péndulo) Slip resistance (Pendulum test)	Class 3
ANSI A137.1	Coefficiente de Fricción Dinámico Dynamic Coefficient of Friction (DCOF)	> 0,42



+ INFO | Pag. 260

Granier floor



Ground Grey_100*275 SP
Ground Grey_100*100 SP

Ground 4D



Ground Grey SP_100x275



Ground Bone SP_100x275

MATCHING WALL COLLECTIONS
GROUND_WHITE BODY | Pag. 205

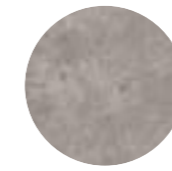
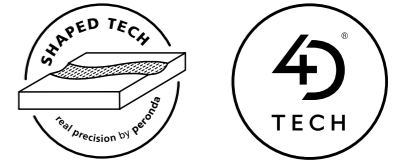

Grey



Silver



Bone

Por motivos estéticos la intensidad de color del formato 100x100 es ligeramente superior a la del formato 100x275 en esta colección.
For aesthetic reasons, the color intensity of the 100x100 format is slightly higher than the 100x275 format in this collection.

GROUND

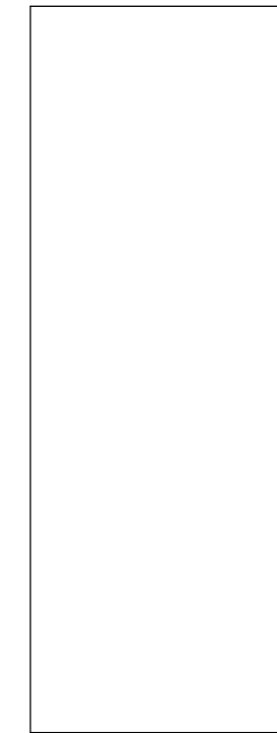

6 patterns

100 * 275 * 0,6 cm | 39 * 108"

RECTIFIED	SHAPED
	BN141
BONE	35904
GREY	35906
SILVER	35905

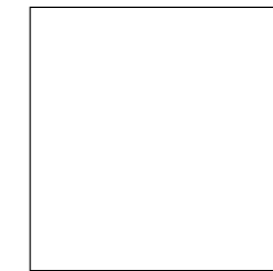

10 patterns

100 * 100 * 0,6 cm | * 39"

RECTIFIED	SHAPED
	BN135
BONE	32889
GREY	32890
SILVER	32888

CARACTERÍSTICAS TÉCNICAS | TECHNICAL CHARACTERISTICS

joint	frost proof	versatile	matt
full body	different shades	shade variation	various graphics

CARACTERÍSTICAS TÉCNICAS ANTIDESLIZAMIENTO | ANTI-SLIP CHARACTERISTICS

Ensayo Essay	Características Features	Resultado Result
UNE 41901 EX	Antideslizamiento (Test del péndulo) Slip resistance (Pendulum test)	SHAPED Class 1
ANSI A137.1	Coefficiente de Fricción Dinámico Dynamic Coefficient of Friction (DCOF)	> 0,42
ISO 10545-6	Resistencia a la Abrasión Profunda Resistance to Deep Abrasion	< 175 mm3



+ INFO | Pag. 260

Ground 4D

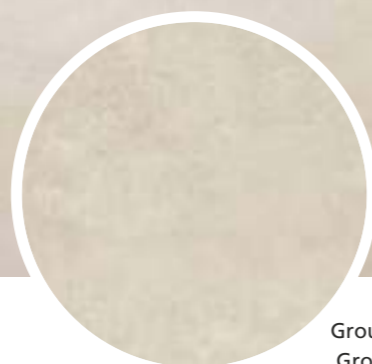

Ground Bone_90*90 SF
Ground Bone_90*90 A

Ground floor



Bone



Silver



Grey



Mila Warm



Mila Cold

MATCHING WALL COLLECTIONS
GROUND_WHITE BODY | Pag. 205

GROUND FLOOR

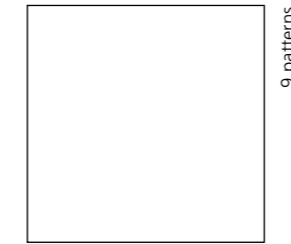

90 * 90 * 1 cm | 36 * 36"

RECTIFIED	SOFT	LAPATTO	ANTISLIP
	BN48	BN42	BN90
BONE	24944	27134	24973
GREY	24792	27135	24974
SILVER	24790	27136	24975



60 * 60 * 1 cm | 24 * 24"

RECTIFIED	SOFT	LAPATTO	ANTISLIP
	BN33	BN38	BN88
BONE	24936	27128	24979
GREY	24937	27130	24980
SILVER	24938	27129	24981

D. GROUND MOSAIC

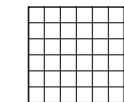

30 * 30 cm | 12 * 12"

NO RECTIFIED	SOFT
	P37
BONE	23435
GREY	23438
SILVER	23439

D. GROUND SPAC

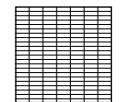

30 * 30 cm | 12 * 12"

NO RECTIFIED	SOFT
	P58
BONE	23505
GREY	23506
SILVER	23507



29 * 90 * 1 cm | 12 * 36"

RECTIFIED	SOFT	LAPATTO
	BN114	BN115
BONE	24920	27119
GREY	24921	27120
SILVER	24922	27121

MILA

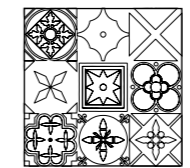

60 * 60 * 1 cm | 24 * 24"

RECTIFIED	SOFT	LAPATTO
	BN40	BN83
WARM	24953	27137
COLD	24952	27138

D. MILA MOSAIC

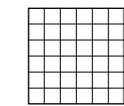

30 * 30 cm | 12 * 12"

NO RECTIFIED	SOFT
	P37
WARM	23441
COLD	23442

CARACTERÍSTICAS TÉCNICAS | TECHNICAL CHARACTERISTICS

joint	frost proof	versatile	matt	full body	different shades	shade variation	various graphics

UNEP	90 * 90 cm 36 * 36"	60 * 60 cm 24 * 24"
	SOFT	SOFT
BONE	U4 P3 E3 C2	U4 P4+ E3 C2
GREY	U4 P3 E3 C2	U4 P4+ E3 C2
SILVER	U4 P3 E3 C2	U4 P4+ E3 C2

CARACTERÍSTICAS TÉCNICAS ANTIDESLIZAMIENTO | ANTI-SLIP CHARACTERISTICS

Ensayo Essay	Características Features	Resultado Result		
		SOFT	LAPATTO	ANTISLIP
DIN 51130	Ángulo crítico (Pies calzados) Critical angle (footwear)	R10	R9	R12
DIN 51097	Ángulo crítico (Pies descalzos) Critical angle (Wet loaded barefoot)	A+B	-	A+B+C
BS-7976-2	Antideslizamiento (Test del péndulo) Slip resistance (Pendulum test-PTV)	+36 Wet	-	+36 Wet
UNE-41901 EX	Antideslizamiento (Test del péndulo) Slip resistance (Pendulum test)	Class 2	Class 2	Class 3
ANSI A137.1	Coefficiente de Fricción Dinámico Dynamic Coefficient of Friction (DCOF)	> 0,42	> 0,42	> 0,42
ISO 10545-6	Resistencia a la Abrasión Profunda Resistance to Deep Abrasion	< 175 mm ³	< 175 mm ³	< 175 mm ³



COMPLEMENTARY PIECE



PIECE POOL



PACKING

+ INFO | Pag. 260

Ground floor

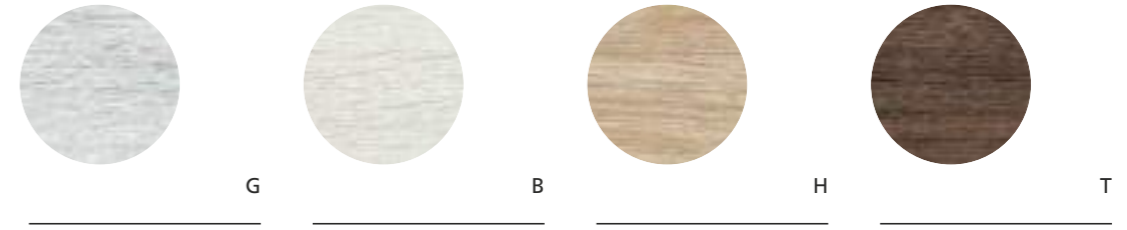

GROVE

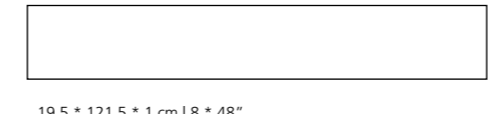

19,5 * 121,5 * 1 cm | 8 * 48"

36 patterns

RECTIFIED	NATURAL
	BN2
G	25486
B	25485
H	25487
T	25488

T.BARCELOS



17 patterns

19,5 * 19,5 cm | 8 * 8"

RECTIFIED	NATURAL
	P23
T. BARCELOS	25371



T.OXIK



30 patterns

19,5 * 19,5 cm | 8 * 8"

RECTIFIED	NATURAL
	P23
T. OXIK	25372



CARACTERÍSTICAS TÉCNICAS | TECHNICAL CHARACTERISTICS

joint	frost proof	versatile	matt	different shades	shade variation	various graphics	various moulds

CARACTERÍSTICAS TÉCNICAS ANTIDESLIZAMIENTO | ANTI-SLIP CHARACTERISTICS

Ensayo Essay	Características Features	Resultado Result
DIN 51130	Ángulo crítico (Pies calzados) Critical angle (footwear)	R9
UNE 41901 EX	Antideslizamiento (Test del péndulo) Slip resistance (Pendulum test)	Class 1
ISO 10545-7	Resistencia a la Abrasión Superficial Resistance to Surface Abrasion	PEI 4



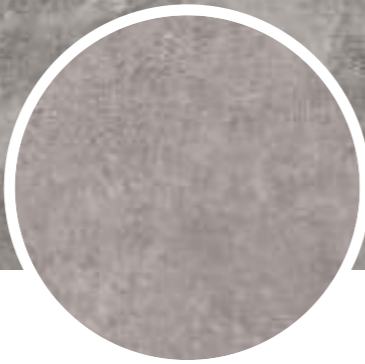

Grunge Grey
AS_90*90

Grunge floor



White



Beige



Grey



Anthracite

MATCHING WALL COLLECTIONS
GRUNGE_WHITE BODY | Pag. 209



GRUNGE floor

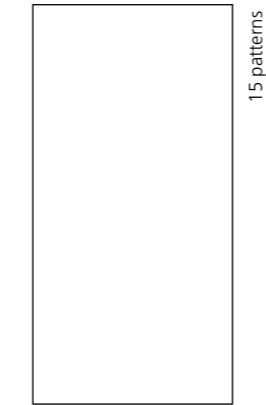

75,5 * 151 * 1 cm 30 * 59"	
RECTIFIED	ALL IN ONE
	BN119
ANTHRACITE	27432
BEIGE	27433
GREY	27434
WHITE	27435

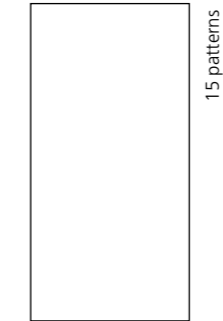

60 * 120 * 1 cm 24 * 48"	
RECTIFIED	ALL IN ONE
	BN116
ANTHRACITE	27400
BEIGE	27401
GREY	27402
WHITE	27399

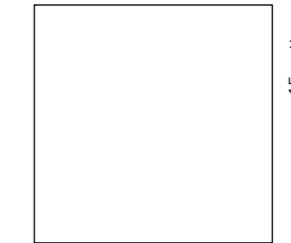

90 * 90 * 1 cm 36 * 36"	
RECTIFIED	ALL IN ONE
	BN90
ANTHRACITE	27424
BEIGE	27425
GREY	27426
WHITE	27427



60 * 60 * 1 cm 24 * 24"	
RECTIFIED	ALL IN ONE
	BN88
ANTHRACITE	27409
BEIGE	27410
GREY	27411
WHITE	27408

D. GRUNGE MOSAIC

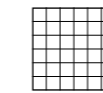

30 * 30 cm 12 * 12"	
NO RECTIFIED	ALL IN ONE
	P37
ANTHRACITE	27603
BEIGE	27605
GREY	27606
WHITE	27607

D. GRUNGE SPAC

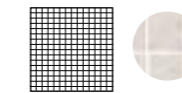

30 * 30 cm 12 * 12"	
NO RECTIFIED	ALL IN ONE
	P58
ANTHRACITE	27608
BEIGE	27609
GREY	27610
WHITE	27611



- 26805** ALUMINIO/60/MAT _ 60 * 0,5 cm | 24 * 0,2" _ **P32**
- 26200** ALUMINIO/90/MAT _ 90 * 0,5 cm | 35 * 0,2" _ **P39**
- 26201** L. GOLDEN/MAT/90 _ 90 * 0,5 cm | 35 * 0,2" _ **P39**



- 20347** L. IRON ANTHRACITE _ 1,5 * 90 cm | 0,6 * 36" _ **P38**
- 20348** L. IRON MOCCHA _ 1,5 * 90 cm | 0,6 * 36" _ **P38**

CARACTERÍSTICAS TÉCNICAS | TECHNICAL CHARACTERISTICS

joint	frost proof	versatile	matt	full body	different shades	shade variation	various graphics

CARACTERÍSTICAS TÉCNICAS ANTIDESLIZAMIENTO | ANTI-SLIP CHARACTERISTICS

Ensayo Essay	Características Features	Resultado Result		90 * 90 cm 36 * 36" 60 * 120 cm 24 * 48"	60 * 60 cm 24 * 24"
DIN 51130	Ángulo crítico (Pies calzados) Critical angle (footwear)	R11		ALL IN ONE	ALL IN ONE
BS 7976-2	Antideslizamiento (Test del péndulo) Slip resistance (Pendulum test-PTV)	+36 Wet		ANTH	U4 P3 E3 C2
UNE 41901 EX	Antideslizamiento (Test del péndulo) Slip resistance (Pendulum test)	Class 3		BEIGE	U4 P3 E3 C2
ANSI A.1371	Coefficiente de Fricción Dinámico Dynamic Coefficient of Friction (DCOF)	> 0,42		GREY	U4 P3 E3 C2
ISO 10545-6	Resistencia a la Abrasión Profunda Resistance to Deep Abrasion	< 175 mm3		WHITE	U4 P3 E3 C2
					U4 P4+ E3 C2



COMPLEMENTARY PIECE



PIECE POOL



PACKING

+ INFO | Pag. 260

Grunge floor

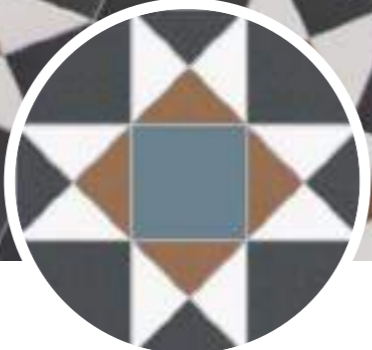

HV-2

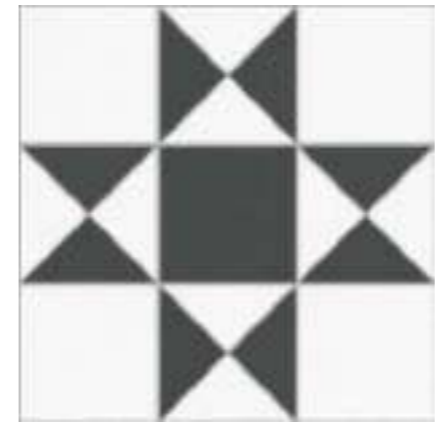

HV-1

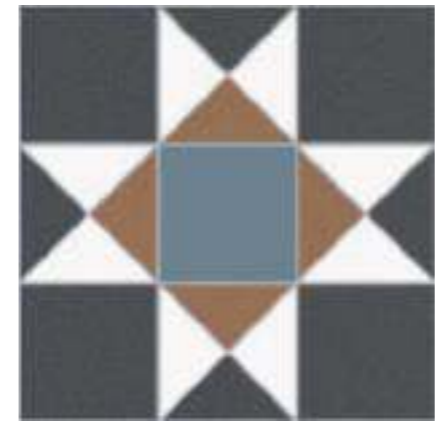

HV-2



C.HV-12



T.HV-12



HV-4



HV-3



C.HV-34



T.HV-34

HV

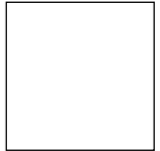

33 * 33 * 0,9 cm | 13 * 13"

NO RECTIFIED	NATURAL
	BN61
HV-1	14644
HV-2	14645
HV-3	14646
HV-4	14647

C.HV

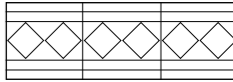

11 * 33 cm | 4 * 13"

NO RECTIFIED	NATURAL
	P12
C.HV-12	14683
C.HV-34	14684

T.HV



11 * 11 cm | 4 * 4"

NO RECTIFIED	NATURAL
	P6
T.HV-12	14685
T.HV-34	14686

CARACTERÍSTICAS TÉCNICAS | TECHNICAL CHARACTERISTICS

joint	frost proof	versatile	matt

CARACTERÍSTICAS TÉCNICAS ANTIDESLIZAMIENTO | ANTI-SLIP CHARACTERISTICS

Ensayo Essay	Características Features	Resultado Result
DIN 51130	Ángulo crítico (Pies calzados) Critical angle (footwear)	R9
UNE 41901 EX	Antideslizamiento (Test del péndulo) Slip resistance (Pendulum test)	Class 1
ISO 10545-7	Resistencia a la Abrasión Superficial Resistance to Surface Abrasion	PEI 4



+ INFO | Pag. 260



Ice Waves_33,3*100
Ice_33,3*100

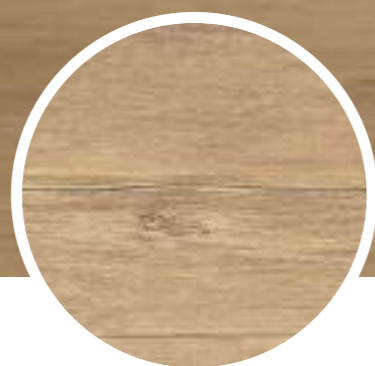

Lenk Honey
AS_24*151

Lenk

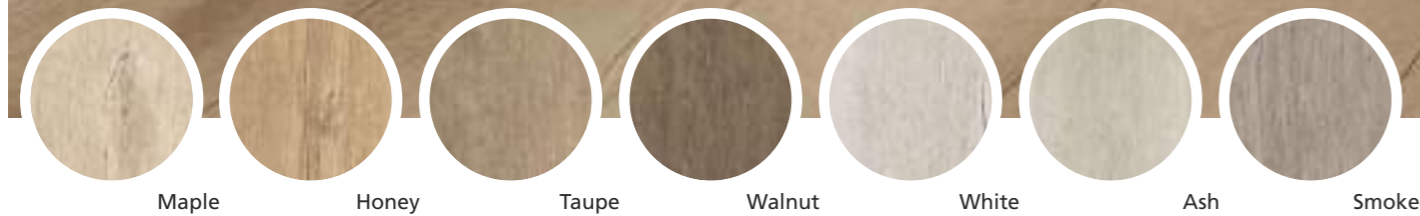

LENK



24 * 151 * 1 cm | 9 * 59"

36 patterns

RECTIFIED	ALL IN ONE
	BN121
ASH	27397
HONEY	27237
MAPLE	27238
SMOKE	27398
TAUPE	27236
WALNUT	27239
WHITE	27475

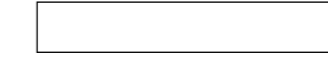

19,5 * 121,5 * 1 cm | 8 * 48"

48 patterns

RECTIFIED	ALL IN ONE
	BN95
ASH	28315
HONEY	28316
MAPLE	28317
SMOKE	28318
TAUPE	28319
WALNUT	28320
WHITE	28321

D. LENK STRIPES

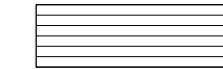

24 * 75 * 1 cm | 9 * 30"

RECTIFIED	ALL IN ONE
	P51
ASH	27756
HONEY	27757
MAPLE	27758
SMOKE	27759
TAUPE	27760
WALNUT	27761
WHITE	27762

*D. LENK TANGRAM

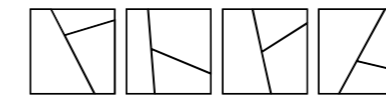

30 * 30 cm | 12 * 12"

RECTIFIED	ALL IN ONE
	P53
ASH	27734
HONEY	27735
MAPLE	27740
SMOKE	27741
TAUPE	27742
WALNUT	27743
WHITE	27744

* Se comercializan en conjuntos de 4 piezas. Precio por pieza individual.
...They are sold in groups of 4 pieces. Price to the individual piece.

D. LENK CHEVRON 1

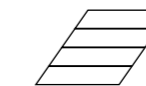

32 * 28 cm | 13 * 11"

RECTIFIED	ALL IN ONE
	P47
ASH	27720
HONEY	27721
MAPLE	27722
SMOKE	27723
TAUPE	27724
WALNUT	27725
WHITE	27726

D. LENK CHEVRON 2

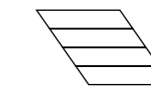

32 * 28 cm | 13 * 11"

RECTIFIED	ALL IN ONE
	P47
ASH	27727
HONEY	27728
MAPLE	27729
SMOKE	27730
TAUPE	27731
WALNUT	27732
WHITE	27733

CARACTERÍSTICAS TÉCNICAS | TECHNICAL CHARACTERISTICS

joint	frost proof	versatile	matt	various moulds	different shades	shade variation	various graphics

CARACTERÍSTICAS TÉCNICAS ANTIDESLIZAMIENTO | ANTI-SLIP CHARACTERISTICS

Ensayo Essay	Características Features	Resultado Result
		ALL IN ONE
DIN 51130	Ángulo crítico (Pies calzados) Critical angle (footwear)	R11
DIN 51097	Ángulo crítico (Pies descalzados) Critical angle (Wet loaded barefoot)	A+B+C
BS 7976-2	Antideslizamiento (Test del péndulo) Slip resistance (Pendulum test-PTV)	+36 Wet
UNE 41901 EX	Antideslizamiento (Test del péndulo) Slip resistance (Pendulum test)	Class 3
ANSI A137.1	Coefficiente de Fricción Dinámico Dynamic Coefficient of Friction (DCOF)	> 0,42

UPEC	24 * 151 cm 9 * 59"
	19,5 * 121,5 cm 8 * 48"
	ALL IN ONE
ASH	U3 P2 E3 C2
HONEY	U3 P2 E3 C2
SMOKE	U2S P2 E3 C2
TAUPE	U2S P2 E3 C2
WALNUT	U3 P2 E3 C2
WHITE	U3 P2 E3 C2



+ INFO | Pag. 260

Lenk



Lucca Beige
SP_100*275

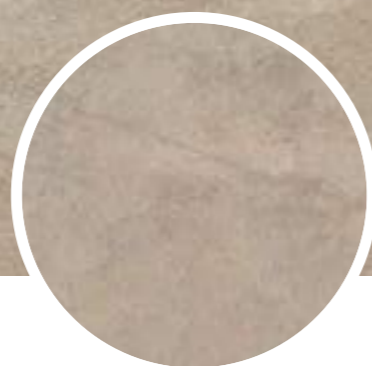

Lucca Beige
SP_100*100

Lucca 4D

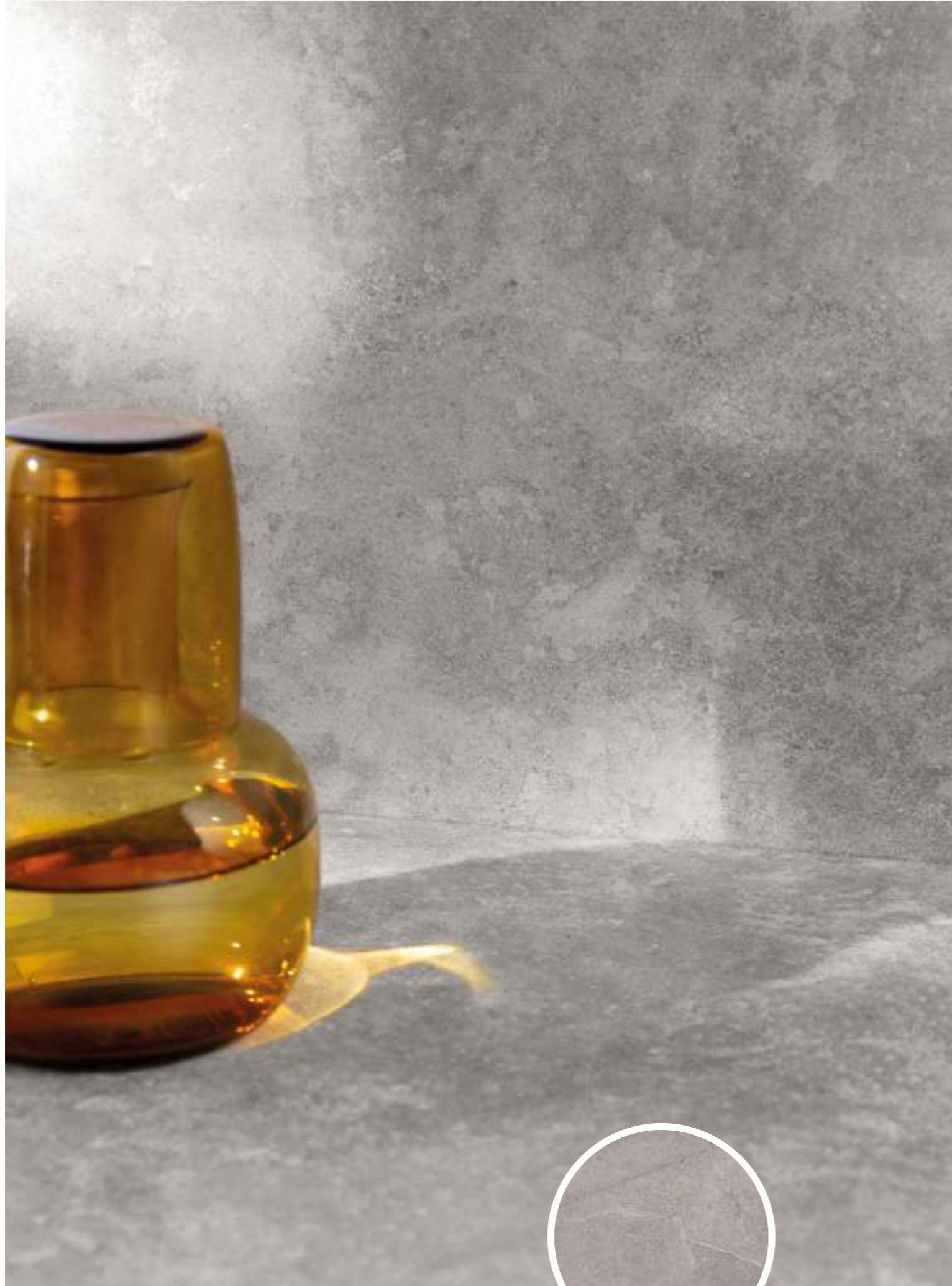

Lucca Grey
SP_100*275



Lucca Beige
SP_100*275

Lucca 4D

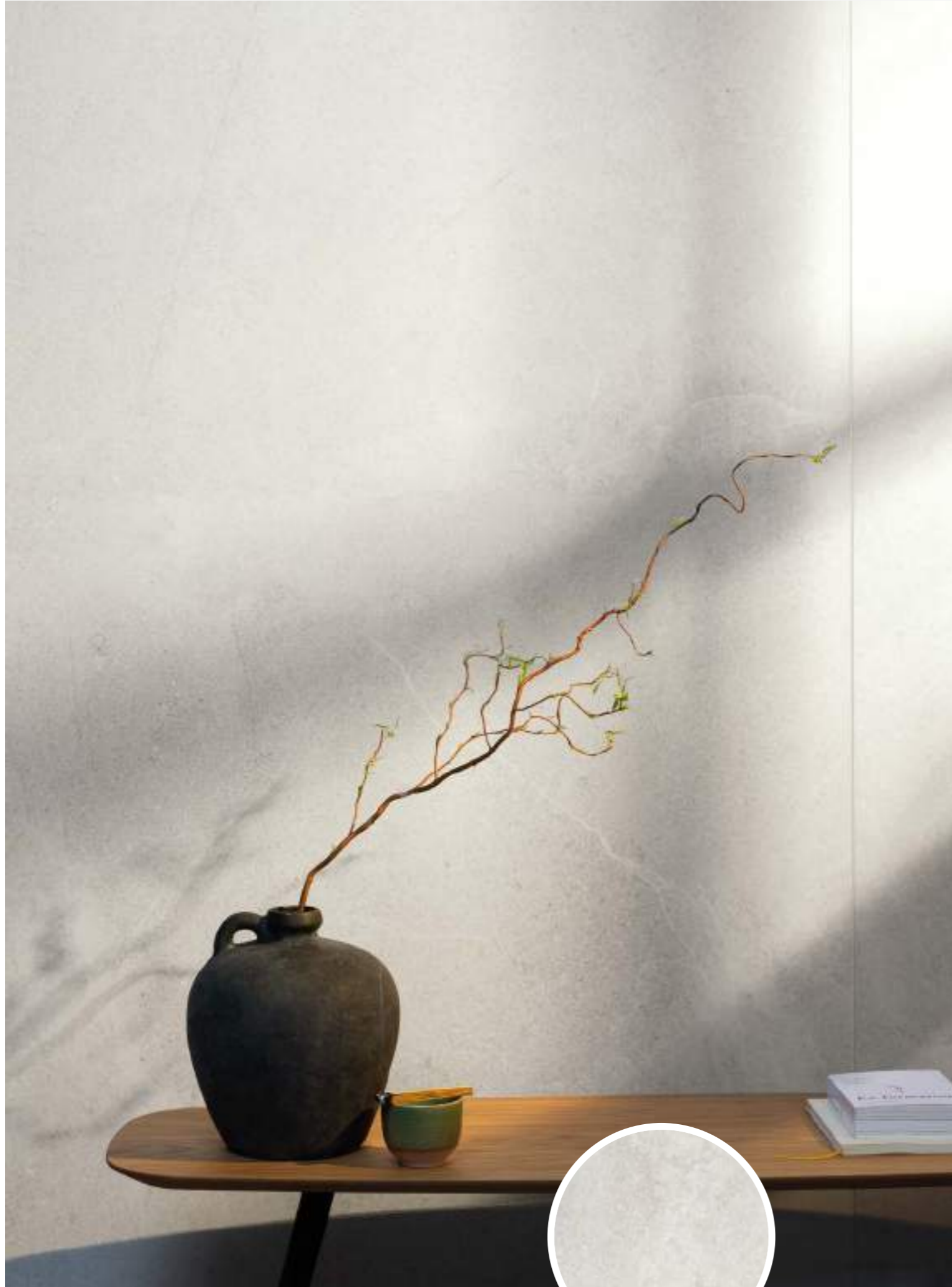

Lucca White
SP_100*275

MATCHING WALL COLLECTIONS
LUCCA_WHITE BODY | Pag. 225

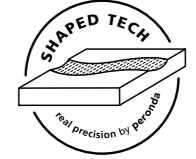

White



Beige

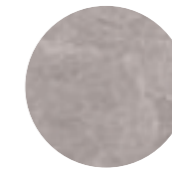

Grey



Anthracite

Por motivos estéticos la intensidad de color de los formatos 100x100 y 100x180 es ligeramente superior a la del formato 100x275 en esta colección.
For aesthetic reasons, the color intensity of the 100x100 and 100x180 formats is slightly higher than the 100x275 format in this collection.

LUCCA

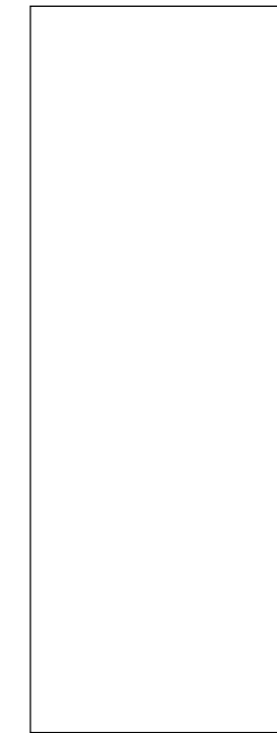

100 * 275 * 0,6 cm | 39 * 108"

	RECTIFIED	SHAPED	
		BN141	BN142
ANTHRACITE	-	-	-
BEIGE		35903	
GREY		35902	
WHITE			35901

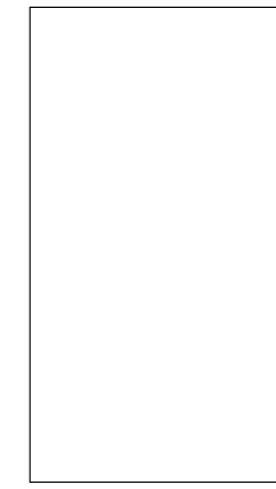

100 * 180 * 0,6 cm | 39 * 71"

	RECTIFIED	SHAPED	
		BN137	BN138
ANTHRACITE		29848	
BEIGE		29850	
GREY		29851	
WHITE			29849

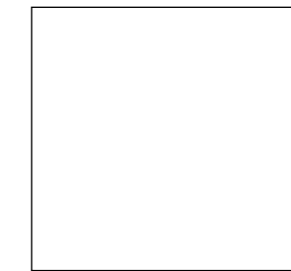

100 * 100 * 0,6 cm | 39 * 39"

	RECTIFIED	SHAPED	
		BN135	BN136
ANTHRACITE		32881	
BEIGE		32880	
GREY		32879	
WHITE			32878

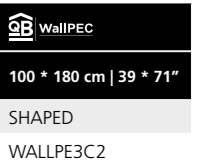

CARACTERÍSTICAS TÉCNICAS
TECHNICAL CHARACTERISTICS

joint	frost proof	versatile	matt	full body
different shades	shade variation	various graphics	thickness	

CARACTERÍSTICAS TÉCNICAS ANTIDESLIZAMIENTO | ANTI-SLIP CHARACTERISTICS

Ensayo Essay	Características Features	Resultado Result
UNE 41901 EX	Antideslizamiento (Test del péndulo) Slip resistance (Pendulum test)	Class 1
ANSI A137.1	Coefficiente de Fricción Dinámico Dynamic Coefficient of Friction (DCOF)	> 0,42
ISO 10545-6	Resistencia a la Abrasión Profunda Resistance to Deep Abrasion	< 175 mm3



+ INFO | Pag. 260

Lucca 4D



Lucca Beige
AS_60*120

Lucca floor



Lucca Grey SP_100*180
Lucca Grey SF_90*90

MATCHING WALL COLLECTIONS
LUCCA_WHITE BODY | Pag. 225



White



Beige

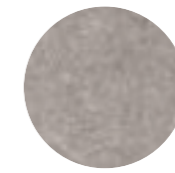

Grey



Anthracite

LUCCA floor



13 patterns

60 * 120 * 1 cm | 24 * 48"

RECTIFIED	ALL IN ONE	HONED	SOFT
	BN116	BN132	BN72
ANTHRACITE	29852	30105	30109
BEIGE	29855	30106	30111
GREY	29853	30107	30110
WHITE	29854	30108	30112

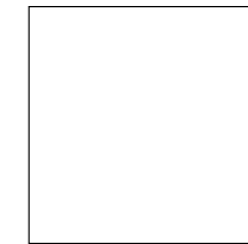

15 patterns

90 * 90 * 1 cm | 36 * 36"

RECTIFIED	ALL IN ONE	HONED	SOFT
	BN90	BN131	BN48
ANTHRACITE	29856	30099	30101
BEIGE	29858	30097	30102
GREY	29857	30100	30103
WHITE	29859	30098	30104



26 patterns

60 * 60 * 1 cm | 24 * 24"

RECTIFIED	NATURAL
	BN33
ANTHRACITE	31354
BEIGE	31355
GREY	31356
WHITE	31357

CARACTERÍSTICAS TÉCNICAS | TECHNICAL CHARACTERISTICS

joint	frost proof	versatile	matt	full body	different shades	shade variation	various graphics

CARACTERÍSTICAS TÉCNICAS ANTIDESLIZAMIENTO | ANTI-SLIP CHARACTERISTICS

Ensayo Essay	Características Features	ALL IN ONE	HONED	SOFT	NATURAL
DIN 51130	Ángulo crítico (Pies calzados) Critical angle (footwear)	R11	-	-	R10
DIN 51097	Ángulo crítico (Pies descalzados) Critical angle (Wet loaded barefoot)	A+B+C	-	-	A+B
BS 7976-2	Antideslizamiento (Test del péndulo) Slip resistance (Pendulum test-PTV)	+36 Wet	-	-	+36 Wet
UNE 41901 EX	Antideslizamiento (Test del péndulo) Slip resistance (Pendulum test)	Class 3	-	Class 1	Class 2
ANSI A137.1	Coefficiente de Fricción Dinámico Dynamic Coefficient of Friction (DCOF)	> 0,42	-	-	> 0,42
ISO 10545-6	Resistencia a la Abrasión Profunda Resistance to Deep Abrasion	< 175 mm ³	< 175 mm ³	< 175 mm ³	< 175 mm ³



+ INFO | Pag. 260

Lucca floor



Manhattan Grey SP_100x275
Manhattan Grey SP_100x100

Manhattan 4D



Manhattan White SP_100x275
Manhattan White SP_100x100 A P.V. | ANG. P.V. | REJ. | ANG.REJ.



Manhattan White
SP_100x275

Manhattan 4D



Manhattan Bone
SP_100x275

Manhattan Silver
SP_100x275

MATCHING WALL COLLECTIONS
MANHATTAN_WHITE BODY | Pag. 229

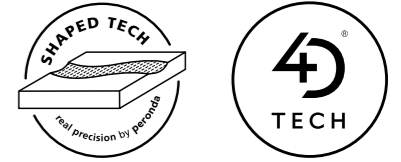

White



Bone

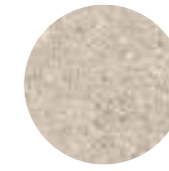

Silver

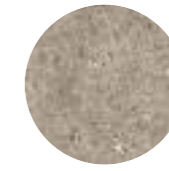

Grey

MANHATTAN 4D



100 * 275 * 0,6 cm
39 * 108"

RECTIFIED	SHAPED
	BN141 BN142
BONE	34685
GREY	34880
SILVER	34686
WHITE	34687

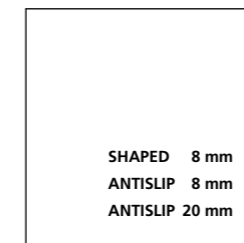

100 * 100 * 0,8 cm
39 * 39"

RECTIFIED	SHAPED	ANTISLIP		ANTISLIP 20mm
	BN135 BN136	BN144	BN143	BN145
BONE	34737	34738		36333
GREY	34735	34740		36334
SILVER	34736	34739		36335
WHITE	34876	34877		36332

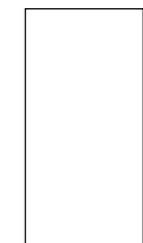

100 * 100 * 2 cm
39 * 39"

RECTIFIED	ANTISLIP 20mm
	BN147
BONE	36911
GREY	36908
SILVER	36909
WHITE	36910

CARACTERÍSTICAS TÉCNICAS
TECHNICAL CHARACTERISTICS

joint	frost proof	versatile	matt	full body
different shades	shade variation	various graphics	thickness	

CARACTERÍSTICAS TÉCNICAS ANTIDESLIZAMIENTO | ANTI-SLIP CHARACTERISTICS

Ensayo Essay	Características Features	Resultado Result	
		SHAPED	ANTISLIP
DIN 51130	Ángulo crítico (Pies calzados) Critical angle (footwear)	-	R11
DIN 51097	Ángulo crítico (Pies descalzos) Critical angle (Wet loaded barefoot)	-	A+B+C
BS 7976-2	Antideslizamiento (Test del péndulo) Slip resistance (Pendulum test-PTV)	-	+36 Wet
UNE 41901 EX	Antideslizamiento (Test del péndulo) Slip resistance (Pendulum test)	Class 1	Class 3
ANSI A137.1	Coefficiente de Fricción Dinámico Dynamic Coefficient of Friction (DCOF)	-	> 0,42
ISO 10545-6	Resistencia a la Abrasión Profunda Resistance to Deep Abrasion	< 175 mm ³	< 175 mm ³



+ INFO | Pag. 260

Manhattan 4D

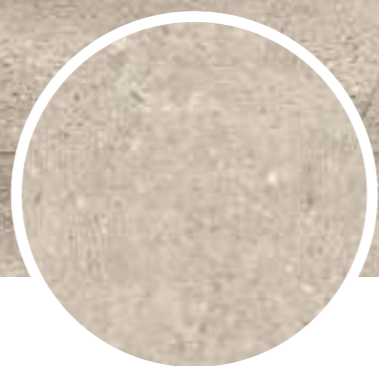

Manhattan Silver
_90*90 AS

Manhattan floor



Manhattan White
_90*90 AS

MATCHING WALL COLLECTIONS
MANHATTAN_WHITE BODY | Pag. 229

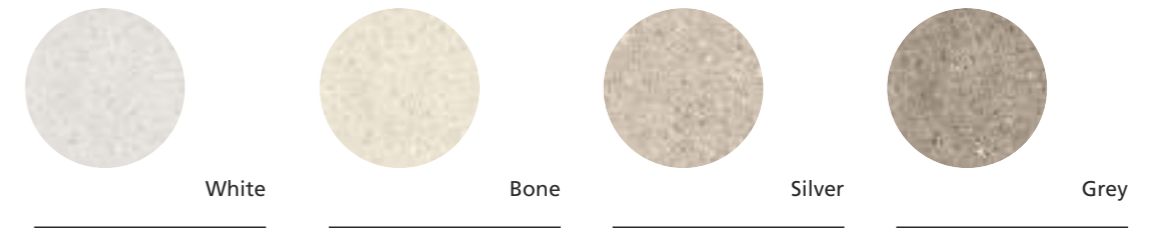

MANHATTAN floor

RECTIFIED	ALL IN ONE	RECTIFIED	ALL IN ONE	RECTIFIED	ALL IN ONE
	BN116	BN90		BN88	
BONE	34745	BONE	34747	BONE	34750
GREY	34742	GREY	34746	GREY	34749
SILVER	34744	SILVER	34748	SILVER	34751
WHITE	34782	WHITE	34874	WHITE	34873

CARACTERÍSTICAS TÉCNICAS | TECHNICAL CHARACTERISTICS

joint	frost proof	versatile	matt	full body	different shades	shade variation	various graphics

CARACTERÍSTICAS TÉCNICAS ANTIDESLIZAMIENTO | ANTI-SLIP CHARACTERISTICS

Ensayo Essay	Características Features	ALL IN ONE
DIN 51130	Ángulo crítico (Pies calzados) Critical angle (footwear)	R11
DIN 51097	Ángulo crítico (Pies descalzados) Critical angle (Wet loaded barefoot)	A+B+C
BS 7976-2	Antideslizamiento (Test del péndulo) Slip resistance (Pendulum test-PTV)	+36 Wet
UNE 41901 EX	Antideslizamiento (Test del péndulo) Slip resistance (Pendulum test)	Class 3
ANSI A137.1	Coefficiente de Fricción Dinámico Dynamic Coefficient of Friction (DCOF)	> 0,42
ISO 10545-6	Resistencia a la Abrasión Profunda Resistance to Deep Abrasion	< 175 mm3

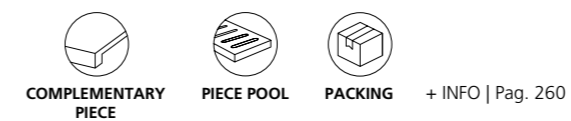

Manhattan floor



Mumble-H_23*180
Mumble-H/A_15*90

Mumble



G

B

H

C

T

MUMBLE

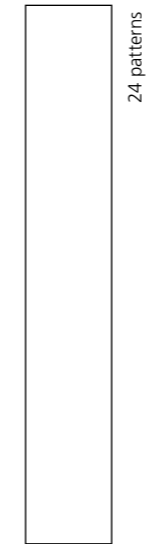

23*180 * 1,1 cm | 9 * 71"

	RECTIFIED	NATURAL
		BN41
G		19358
B		19356
C		19357
H		19359
T		19360

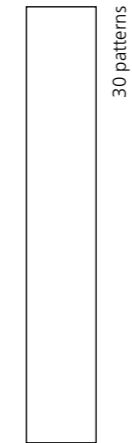

19,5 * 121,5 * 1 cm | 8 * 48"

	RECTIFIED	NATURAL
		BN2
G		25351
B		25346
C		25350
H		25352
T		25353

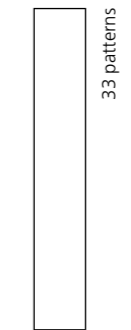

15 * 90 * 1 cm | 6 * 36"

	RECTIFIED	NATURAL	ANTISLIP
		BN27	BN76
G		25334	25338
B		25331	25332
C		25333	25337
H		25335	25339
T		25336	25340

BARCELOS



15 * 90 * 1 cm | 6 * 36"

	RECTIFIED	NATURAL
		BN76
BARCELOS		25369

T.BARCELOS



19,5 * 19,5 cm | 8 * 8"

	RECTIFIED	NATURAL
		P23
T. BARCELOS		25371

T.OXIK



19,5 * 19,5 cm | 8 * 8"

	RECTIFIED	NATURAL
		P23
T. OXIK		25372

**CARACTERÍSTICAS TÉCNICAS
TECHNICAL CHARACTERISTICS**

joint	frost proof	versatile	matt
different shades	shade variation	various graphics	various moulds

CARACTERÍSTICAS TÉCNICAS ANTIDESLIZAMIENTO | ANTI-SLIP CHARACTERISTICS

Ensayo Essay	Características Features	Resultado Result	
		NATURAL	ANTISLIP
DIN 51130	Ángulo crítico (Pies calzados) Critical angle (footwear)	R9	R11
DIN 51097	Ángulo crítico (Pies descalzos) Critical angle (Wet loaded barefoot)	-	A+B+C
BS 7976-2	Antideslizamiento (Test del péndulo) Slip resistance (Pendulum test-PTV)	-	+36 Wet
UNE 41901 EX	Antideslizamiento (Test del péndulo) Slip resistance (Pendulum test)	Class 1	Class 3
AINSI A137.1	Coefficiente de Fricción Dinámico Dynamic Coefficient of Friction (DCOF)	-	> 0,42
ISO 10545-7	Resistencia a la Abrasión Superficial Resistance to Surface Abrasion	PEI 4	PEI 4



COMPLEMENTARY PIECE



PIECE POOL



PACKING

+ INFO | Pag. 260

Mumble

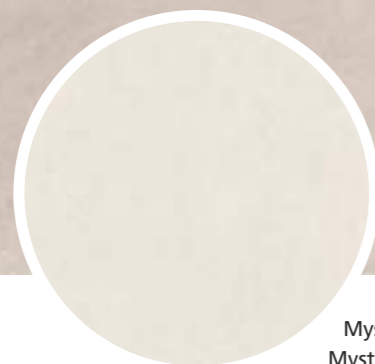

Mystic White_100*100 BH
Mystic White_100*100 BHA



White



Sand



Grey

MYSTIC 4D

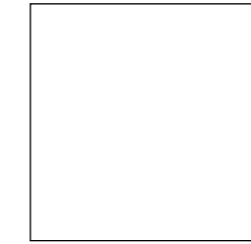

12 patterns

100 * 100 * 0,8 cm | 39 * 39"

RECTIFIED	NATURAL	BUSH HAMMERED	ANTISLIP BUSH HAMMERED
	BN94	BN94	BN99
WHITE	25394	25391	25390
SAND	24340	24344	24355
GREY	24342	24346	24354

D. MYSTIC MOSAIC

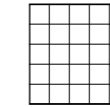

25 * 25 cm | 10 * 10"

NO RECTIFIED	NATURAL
	P39
WHITE	25428
SAND	24479
GREY	24477

D. MYSTIC BRICK



29,8 * 29,2 cm | 12 * 12"

NO RECTIFIED	NATURAL
	P50
WHITE	25427
SAND	24461
GREY	24459



22303 ALUMINIO/100/MAT _ 100 * 0,5 cm
39 * 0,2" _ P42



26153 L. GOLDEN/MAT/100 _ 100 * 0,5 cm
39 * 0,2" _ P42

CARACTERÍSTICAS TÉCNICAS | TECHNICAL CHARACTERISTICS

joint	frost proof	versatile	matt	full body	different shades	shade variation	various graphics	thickness

CARACTERÍSTICAS TÉCNICAS ANTIDESLIZAMIENTO | ANTI-SLIP CHARACTERISTICS

Ensayo Essay	Características Features	Resultado Result		
		NATURAL	ANTISLIP BUSH HAMMERED	ANTISLIP BUSH HAMMERED
DIN 51130	Ángulo crítico (Pies calzados) Critical angle (footwear)	R9	R10	R11
DIN 51097	Ángulo crítico (Pies descalzos) Critical angle (Wet loaded barefoot)	-	A+B	A+B+C
BS 7976-2	Antideslizamiento (Test del péndulo) Slip resistance (Pendulum test-PTV)	-	+36 Wet	+36 Wet
UNE 41901 EX	Antideslizamiento (Test del péndulo) Slip resistance (Pendulum test)	Class 1	Class 2	Class 3
ANSI A137.1	Coefficiente de Fricción Dinámico Dynamic Coefficient of Friction (DCOF)	>0,42	>0,42	>0,42
ISO 10545-6	Resistencia a la Abrasión Profunda Resistance to Deep Abrasion	< 175 mm3	< 175 mm3	< 175 mm3



COMPLEMENTARY PIECE



PIECE POOL



PACKING

+ INFO | Pag. 260

Mystic 4D



Nature White_60*120 SF Nature White_60*60 BHA D. Nature Mosaic
P.V ANG.P.V. E.P.V Rej. Ang.Rej. T.Rej. Nature White

Nature floor



White



Beige



Grey



Anthracite

MATCHING WALL COLLECTIONS
NATURE_WHITE BODY | Pag. 237

NATURE

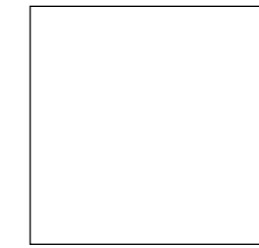

90 * 90 * 1 cm | 36 * 36"

	ANTISLIP BUSH HAMMERED	
	RECTIFIED	SOFT
		BN48 BN90
WHITE	25742	25755
GREY	25747	25756
BEIGE	25748	25757
ANTHRACITE	25749	25758

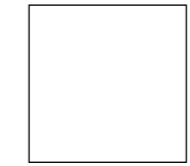

60 * 60 * 1 cm | 24 * 24"

	ANTISLIP BUSH HAMMERED	
	RECTIFIED	SOFT
		BN33 BN88
WHITE	25764	25801
GREY	25765	25802
BEIGE	25766	25803
ANTHRACITE	25767	25804

D. NATURE MOSAIC

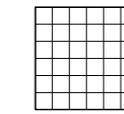

30 * 30 cm | 12 * 12"

	NO RECTIFIED	
	RECTIFIED	SOFT
		P37
WHITE	26086	
GREY	26084	
BEIGE	26083	
ANTHRACITE	26082	

D. NATURE SPAC

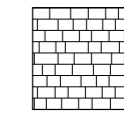

30 * 30 cm | 12 * 12"

	NO RECTIFIED	
	RECTIFIED	SOFT
		P58
WHITE	26101	
GREY	26099	
BEIGE	26098	
ANTHRACITE	26097	

RHOM. NATURE

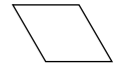

14,8 * 17 cm | 6 * 7"

	NO RECTIFIED	
	RECTIFIED	SOFT
		P17
WHITE	26189	
GREY	26188	
BEIGE	26187	
ANTHRACITE	26186	

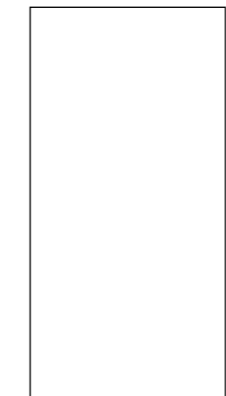

75,5 * 151 * 1 cm | 30 * 59"

	ANTISLIP BUSH HAMMERED	
	RECTIFIED	SOFT
		BN118
WHITE	25841	
GREY	25842	
BEIGE	25843	
ANTHRACITE	25844	

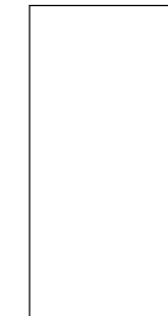

60 * 120 * 1 cm | 24 * 48"

	ANTISLIP BUSH HAMMERED	
	RECTIFIED	SOFT
		BN116
WHITE	25818	25829
GREY	25819	25830
BEIGE	25820	25831
ANTHRACITE	25821	25832

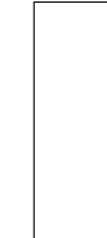

29 * 90 * 1 cm | 12 * 36"

	NO RECTIFIED	
	RECTIFIED	SOFT
		BN114
WHITE	26212	
GREY	26211	
BEIGE	26210	
ANTHRACITE	26204	

UPEEC	
SOFT	
90 * 90 cm 36 * 36"	
60 * 120 cm 24 * 48"	
U4 P3 E3 C2	
60 * 60 cm 24 * 24"	
U4 P4+ E3 C2	

CARACTERÍSTICAS TÉCNICAS
TECHNICAL CHARACTERISTICS

joint	frost proof	versatile	full body
different shades	shade variation	various graphics	

CARACTERÍSTICAS TÉCNICAS ANTIDESLIZAMIENTO | ANTI-SLIP CHARACTERISTICS

Ensayo Essay	Características Features	Resultado Result	
		SOFT	ANTISLIP BH
DIN 51130	Ángulo crítico (Pies calzados) Critical angle (footwear)	R10	R11
DIN 51097	Ángulo crítico (Pies descalzos) Critical angle (Wet loaded barefoot)	A+B	A+B+C
BS 7976-2	Antideslizamiento (Test del péndulo) Slip resistance (Pendulum test-PTV)	+36 Wet	+36 Wet
UNE 41901 EX	Antideslizamiento (Test del péndulo) Slip resistance (Pendulum test)	Class 2	Class 3
ANSI A.1371	Coefficiente de Fricción Dinámico Dynamic Coefficient of Friction (DCOF)	> 0,42	> 0,42
ISO 10545-6	Resistencia a la Abrasión Profunda Resistance to Deep Abrasion	< 175 mm³	< 175 mm³



COMPLEMENTARY PIECE



PIECE POOL



PACKING

+ INFO | Pag. 260

Nature floor



Planet White



Planet Silver_60*60 A P.V. | Ang. PV | E.P.V. | Rej. | Ang.Rej. | T. Rej. | P. | D. Planet Silver Mosaic



Planet Bone SF_90x90

Planet



Anthracite



Silver



White



Bone



Mud

PLANET

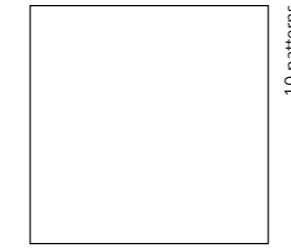

90 * 90 * 1 cm | 36 * 36"

RECTIFIED	SOFT	NATURAL	ANTISLIP
	BN48	BN48	BN90
ANTH	25019	25061	25056
SILVER	25023	25065	25060
BONE	25020	25062	25057
MUD	25022	25064	25059
WHITE	25774	25776	-

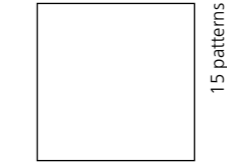

60 * 60 * 1 cm | 24 * 24"

RECTIFIED	SOFT	NATURAL	ANTISLIP
	BN33	BN33	BN88
ANTH	25071	25101	25076
SILVER	25075	25105	25080
BONE	25072	25102	25077
MUD	25074	25104	25079
WHITE	25190	25780	-

D. PLANET MOSAIC

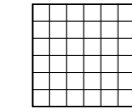

30 * 30 cm | 12 * 12"

NO RECTIFIED	SOFT
	P37
ANTH	22502
SILVER	22504
BONE	22505
MUD	22506
WHITE	25800

ARR. PLANET

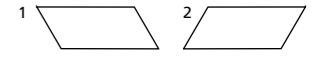

34,4 * 14,6 cm | 14 * 6"

NO RECTIFIED	SOFT
	P35
	1 2
ANTH	22490 22495
SILVER	22494 22499
BONE	22491 22496
MUD	22493 22498
WHITE	25794 25796

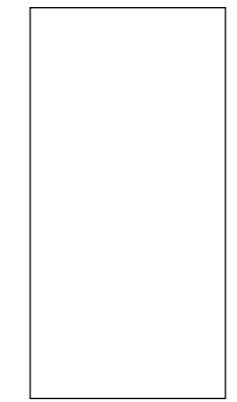

75,5 * 151 * 1 cm | 30 * 59"

RECT.	SOFT
	BN118
ANTH	26064
SILVER	26065
BONE	26068
MUD	26069
WHITE	26066



60 * 120 * 1 cm | 24 * 48"

RECT.	SOFT
	BN72
ANTH	25177
SILVER	25180
BONE	25179
MUD	25178
WHITE	25181

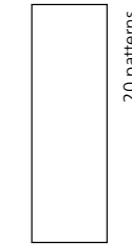

29 * 90 * 1 cm | 12 * 36"

RECT.	SOFT
	BN114
ANTH	25009
SILVER	25013
BONE	25010
MUD	25012
WHITE	25812

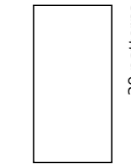

30 * 60 * 1 cm | 12 * 24"

RECT.	SOFT
	BN39
ANTH	25096
SILVER	25100
BONE	25097
MUD	25099
WHITE	25187

TRI. PLANET

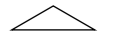

8,6 * 29,6 cm | 3 * 12"

NO RECTIFIED	SOFT
	P15
ANTH	22485
SILVER	22489
BONE	22486
MUD	22488
WHITE	25798

CARACTERÍSTICAS TÉCNICAS | TECHNICAL CHARACTERISTICS

joint	frost proof	versatile	matt	full body	different shades	shade variation	variousgraphics

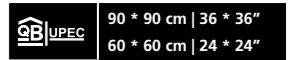

SOFT U4 P3 E3 C2

CARACTERÍSTICAS TÉCNICAS ANTIDESLIZAMIENTO | ANTI-SLIP CHARACTERISTICS

Ensayo Essay	Características Features	Resultado Result		
		SOFT	NATURAL	ANTISLIP
DIN 51130	Ángulo crítico (Pies calzados) Critical angle (footwear)	R9	R10	R12
DIN 51097	Ángulo crítico (Pies descalzos) Critical angle (Wet loaded barefoot)	A+B	A+B	A+B+C
BS 7976-2	Antideslizamiento (Test del péndulo) Slip resistance (Pendulum test-PTV)	+36 Wet	+36 Wet	+36 Wet
UNE 41901 EX	Antideslizamiento (Test del péndulo) Slip resistance (Pendulum test)	Class 1	Class 2	Class 3
AINSI A137.1	Coefficiente de Fricción Dinámico Dynamic Coefficient of Friction (DCOF)	> 0,42	> 0,42	> 0,42
ISO 10545-6	Resistencia a la Abrasión Profunda Resistance to Deep Abrasion	< 175 mm3	< 175 mm3	< 175 mm3



COMPLEMENTARY PIECE



PIECE POOL



PACKING

+ INFO | Pag. 260

Planet



Satya-H_90*90



Satya-G_90*90 R. R.P. P.V. Ang. P.V. E.P.V. Rej. Ang. Rej.

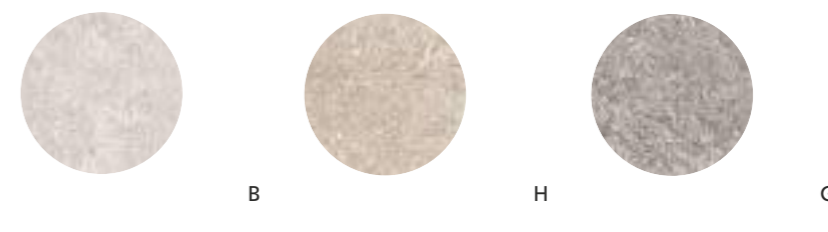

SATYA

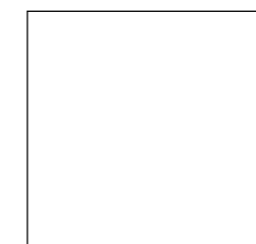

90 * 90 * 1 cm | 36 * 36"

RECTIFIED	NATURAL	ANTISLIP
	BN48	BN90
B	25442	25445
H	25444	25447
G	25443	25446

D. SATYER

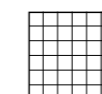

30 * 30 cm | 12 * 12"

NO RECTIFIED	NATURAL
	P45
B	21424
H	21415
G	21416



26201 L. GOLDEN/MAT/90 _ 90 * 0,5 cm
35 * 0,2" _ **P39**



26200 ALUMINIO/90/MAT _ 90 * 0,5 cm
35 * 0,2" _ **P39**

CARACTERÍSTICAS TÉCNICAS | TECHNICAL CHARACTERISTICS

joint	frost proof	versatile	matt	shade variation	various graphics	different shades

LUPEC	90 * 90 cm 36 * 36"
	NATURAL ANTISLIP

CARACTERÍSTICAS TÉCNICAS ANTIDESLIZAMIENTO | ANTI-SLIP CHARACTERISTICS

Ensayo Essay	Características Features	Resultado Result
SATYA B	U3 P3 E3 C2	NATURAL ANTISLIP
SATYA G	U2S P3 E3 C2	DIN 51130 Ángulo crítico (Pies calzados) Critical angle (footwear)
SATYA H	U3 P3 E3 C2	DIN 51097 Ángulo crítico (Pies descalzos) Critical angle (Wet loaded barefoot)
SATYA B/A	U3S P3 E3 C2	BS 7976-2 Antideslizamiento (Test del péndulo) Slip resistance (Pendulum test-PTV)
SATYA G/A	U2S P3 E3 C2	UNE 41901 EX Antideslizamiento (Test del péndulo) Slip resistance (Pendulum test)
SATYA H/A	U3S P3 E3 C2	ANSI A137.1 Coeficiente de Fricción Dinámico Dynamic Coefficient of Friction (DCOF)
	ISO 10545-7 Resistencia a la Abrasión Superficial Resistance to Surface Abrasion	PEI 4 PEI 4



+ INFO | Pag. 260

Satya



Shark-N_60*60

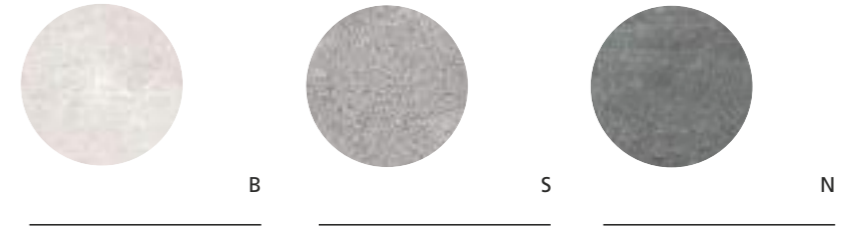

SHARK

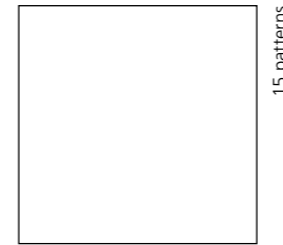

90 * 90 * 1 cm | 36 * 36"

	RECTIFIED	NATURAL	LAPATTO
		BN48	BN42
B		25531	25534
S		25532	25535
N		25533	25536

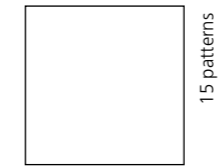

60 * 60 * 1 cm | 24 * 24"

	RECTIFIED	NATURAL	LAPATTO
		BN33	BN38
B		25527	25524
S		25528	25525
N		25529	25526

MOTOWN

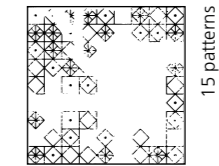

60 * 60 * 1 cm | 24 * 24"

	RECTIFIED	NATURAL	LAPATTO
		BN40	BN83
B		25556	25570
S		25569	25571
N		25568	25572



26201 L. GOLDEN/MAT/90 _ 90 * 0,5 cm
35 * 0,2" _ P39



26200 ALUMINIO/90/MAT _ 90 * 0,5 cm
35 * 0,2" _ P39

CARACTERÍSTICAS TÉCNICAS | TECHNICAL CHARACTERISTICS

joint	frost proof	versatile	matt	different shades	shade variation	various graphics

CARACTERÍSTICAS TÉCNICAS ANTIDESLIZAMIENTO | ANTI-SLIP CHARACTERISTICS

Ensayo Essay	Características Features	Resultado Result	
		NATURAL	LAPATTO
DIN 51130	Ángulo crítico (Pies calzados) Critical angle (footwear)	R10	R9
DIN 51097	Ángulo crítico (Pies descalzos) Critical angle (Wet loaded barefoot)	A+B	-
BS 7976-2	Antideslizamiento (Test del péndulo) Slip resistance (Pendulum test-PTV)	+36 Wet	-
UNE 41901 EX	Antideslizamiento (Test del péndulo) Slip resistance (Pendulum test)	Class 2	Class 2
ISO 10545-7	Resistencia a la Abrasión Superficial Resistance to Surface Abrasion	PEI 4	PEI 4

LUPEC	60 * 60 cm 24 * 24"	
	NATURAL	LAPATTO
SHARK B	U3S P3 E3 C2	U4 P4 E3 C2
SHARK S	U3 P3 E3 C2	U4 P4 E3 C2
SHARK N	U3 P3 E3 C2	U4 P4 E3 C2



+ INFO | Pag. 260

Shark



Unique_19,5 * 121,5
T.Oxik

UNIQUE



19,5 * 121,5 * 1 cm | 8 * 48"

RECTIFIED	NATURAL
	BN2
UNIQUE	25645

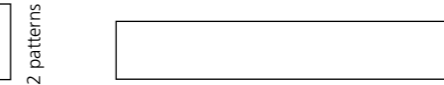

15 * 90 * 1 cm | 6 * 36"

RECTIFIED	NATURAL
	BN27
UNIQUE	25646

T.BARCELOS



17 patterns

19,5 * 19,5 cm | 8 * 8"

RECTIFIED	NATURAL
	P23
T. BARCELOS	25371

T. BARCELOS



T.OXIK



30 patterns

19,5 * 19,5 cm | 8 * 8"

RECTIFIED	NATURAL
	P23
T. OXIK	25372

T. OXIK



CARACTERÍSTICAS TÉCNICAS | TECHNICAL CHARACTERISTICS

joint	frost proof	versatile	matt/ gloss	different shades	shade variation	various graphics	various moulds

CARACTERÍSTICAS TÉCNICAS ANTIDESLIZAMIENTO | ANTI-SLIP CHARACTERISTICS

Ensayo Essay	Características Features	Resultado Result
DIN 51130	Ángulo crítico (Pies calzados) Critical angle (footwear)	R9
UNE 41901 EX	Antideslizamiento (Test del péndulo) Slip resistance (Pendulum test)	Class 1



+ INFO | Pag. 260

Unique

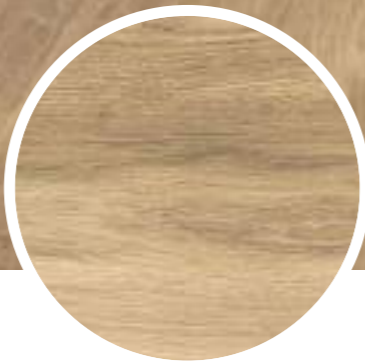

Verbier Honey
_24*151 AS

Verbier floor



Verbier Ash_24*151 AS



Verbier Taupe_24*151 AS

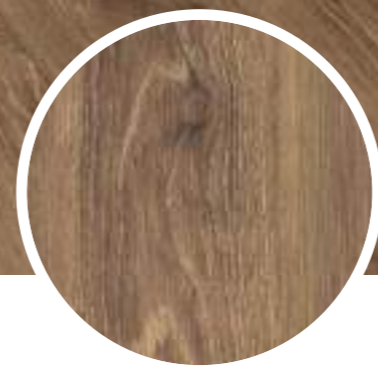

Verbier Cigar
_24*151 AS

Verbier floor



Verbier Straw
_24*151 AS

MATCHING WALL COLLECTIONS
VERBIER_WHITE BODY | Pag. 255

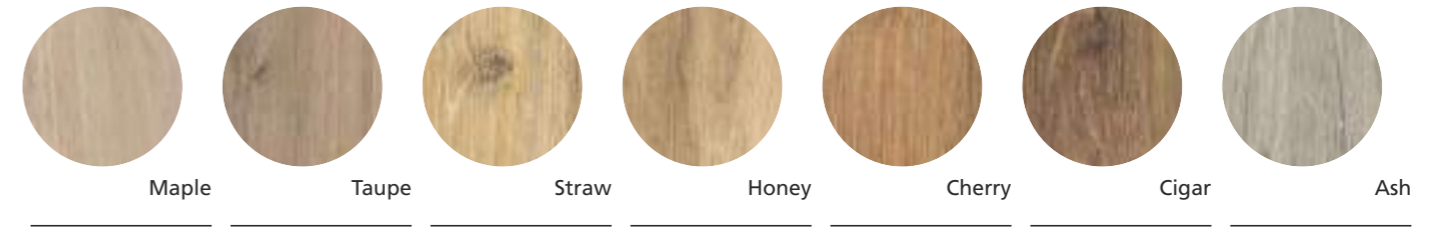

VERBIER floor



24 * 151 * 1 cm | 9 * 59"

36 patterns

RECTIFIED	ALL IN ONE
	BN121
ASH	31730
CHERRY	31599
CIGAR	31601
HONEY	31604
MAPLE	31603
STRAW	31600
TAUPE	31602

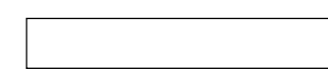

19,5 * 121,5 * 1 cm | 8 * 48"

48 patterns

RECTIFIED	ALL IN ONE
	BN95
ASH	32079
CHERRY	32080
CIGAR	32081
HONEY	32078
MAPLE	32082
STRAW	32083
TAUPE	32084

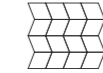

24 * 27,5 * 1 cm | 9 * 12"

RECTIFIED	ALL IN ONE
	P53
ASH	32092
CHERRY	32093
CIGAR	32094
HONEY	32095
MAPLE	32096
STRAW	32097
TAUPE	32098

D. VERBIER CHEV.

CARACTERÍSTICAS TÉCNICAS | TECHNICAL CHARACTERISTICS

joint	frost proof	versatile	matt	varios moulds	different shades	shade variation	various graphics

CARACTERÍSTICAS TÉCNICAS ANTIDESLIZAMIENTO | ANTI-SLIP CHARACTERISTICS

Ensayo Essay	Características Features	Resultado Result
		ALL IN ONE
DIN 51130	Ángulo crítico (Pies calzados) Critical angle (footwear)	R11
DIN 51097	Ángulo crítico (Pies descalzados) Critical angle (Wet loaded barefoot)	A+B+C
BS 7976-2	Antideslizamiento (Test del péndulo) Slip resistance (Pendulum test-PTV)	+36 Wet
UNE-ENV 12633	Antideslizamiento (Test del péndulo) Slip resistance (Pendulum test)	Class 3
ANSI A137.1	Coefficiente de Fricción Dinámico Dynamic Coefficient of Friction (DCOF)	> 0,42



+ INFO | Pag. 260

Verbier floor



Nature White
Decor_32*90



Whistler Honey
_24*151 A

Whistler



Whistler Honey
_24*151

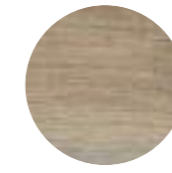

Taupe



Maple



Honey

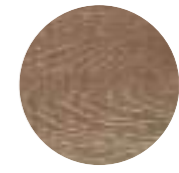

Brown

WHISTLER



30 patterns

24 * 151 * 1 cm | 9 * 59"

RECTIFIED	NATURAL	ANTISLIP
	BN93	BN121
BROWN	23930	25370
HONEY	23929	25376
MAPLE	23928	25377
TAUPE	23927	25378

CARACTERÍSTICAS TÉCNICAS | TECHNICAL CHARACTERISTICS

joint	frost proof	versatile	matt	different shades	shade variation	various graphics	various moulds

CARACTERÍSTICAS TÉCNICAS ANTIDESLIZAMIENTO | ANTI-SLIP CHARACTERISTICS

Ensayo Essay	Características Features	Resultado Result	
		NATURAL	ANTISLIP
DIN 51130	Ángulo crítico (Pies calzados) Critical angle (footwear)	R9	R11
DIN 51097	Ángulo crítico (Pies descalzos) Critical angle (Wet loaded barefoot)	-	A+B
BS 7976-2	Antideslizamiento (Test del péndulo) Slip resistance (Pendulum test-PTV)	-	+36 Wet
UNE 41901 EX	Antideslizamiento (Test del péndulo) Slip resistance (Pendulum test)	Class 1	Class 3
AINSI A137.1	Coefficiente de Fricción Dinámico Dynamic Coefficient of Friction (DCOF)	> 0,42	> 0,42
ISO 10545-7	Resistencia a la Abrasión Superficial Resistance to Surface Abrasion	HONEY_PEI 4	PEI 4



+ INFO | Pag. 260

Whistler

WHITE

BODY

tiles

CLUNY wall	171
COTTON	177
DANUBIO	181
DONNA	183
DOWNTOWN wall	185
ERTA	191
FROZEN	193
GHENT wall	197
GRANIER wall	201
GROUND wall	205
GRUNGE wall	209
ICE	217
LACCIO	223
LUCCA wall	225
MANHATTAN wall	229
MITTE wall	235
NATURE wall	237
PALETTE	239
PURE	243
SALINES	251
VERBIER wall	255
VIBRATO	259
PIEZA COMPLEMENTARIA COMPLEMENTARY PIECE	261
PIEZA PISCINA POOL PIECE	263
EMBALAJE PACKING	265



Cluny
White_33,3*100



Cluny decor
White_33,3*100

Cluny wall



Cluny Sand_33,3*100
Cluny Textured Sand_33,3*100

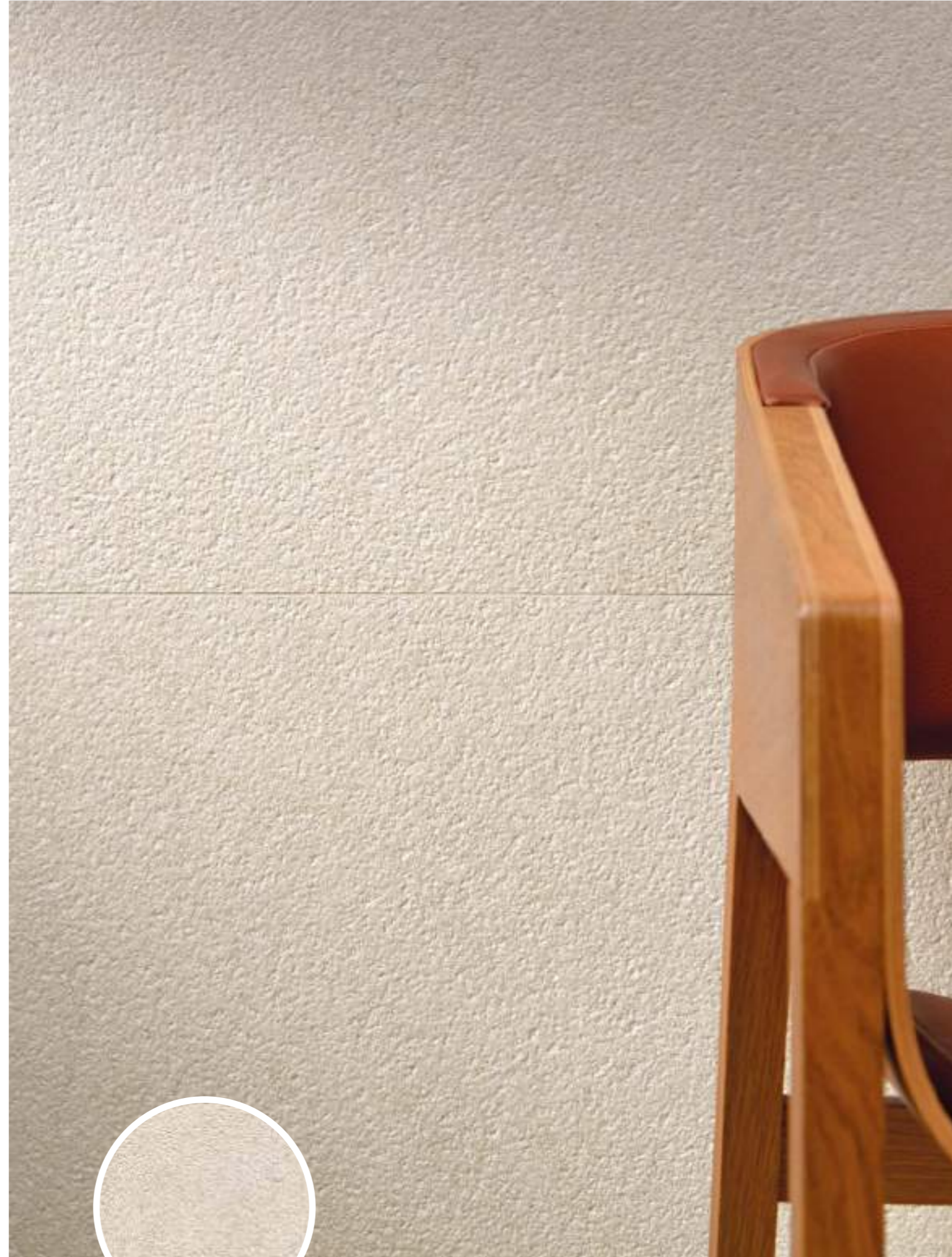

Cluny Textured
Sand_33,3*100

Cluny wall



CLUNY White



CLUNY White
Texture



CLUNY Sand



CLUNY Sand
Texture



CLUNY Silver



CLUNY Silver
Texture

CLUNY



12 patterns

33,3 * 100 * 0,75 cm | 13 * 39"

RECTIFIED	NATURAL
	BN65
SAND	36365
SILVER	36366
WHITE	36363

CLUNYTEXTURED



12 patterns

33,3 * 100 * 0,75 cm | 13 * 39"

RECTIFIED	NATURAL
	BN65
SAND	36368
SILVER	36370
WHITE	36364

MATCHING FLOOR COLLECTIONS
CLUNY_PORCELAIN | Pag. 69



CLUNY White
Decor



CLUNY Sand
Decor



CLUNY Silver
Decor

CLUNY DECOR

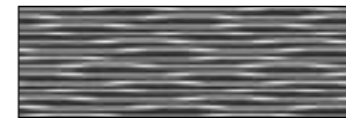

12 patterns

33,3 * 100 * 0,86 cm | 13 * 39"

RECTIFIED	NATURAL
	BN66
SAND	36369
SILVER	36371
WHITE	36367

CLUNY FLOOR



CLUNY White

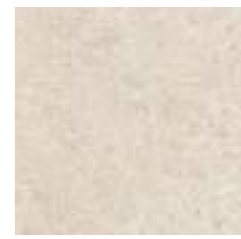

CLUNY Sand



CLUNY Beige

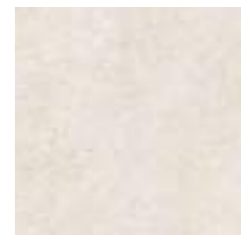

CLUNY Silver

CLUNY FLOOR

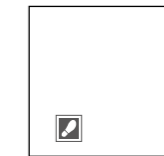

10 patterns

100 * 100 * 0,8 cm
39 * 39"

RECTIFIED	SHAPED	
	BN135	BN136
BEIGE	36337	
SAND	36338	
SILVER	36339	
WHITE	36336	

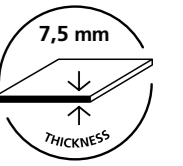

CARACTERÍSTICAS TÉCNICAS | TECHNICAL CHARACTERISTICS

joint	wall tiles	matt	different shades	shade variation	various graphics



PACKING + INFO | Pag. 264

Cluny wall

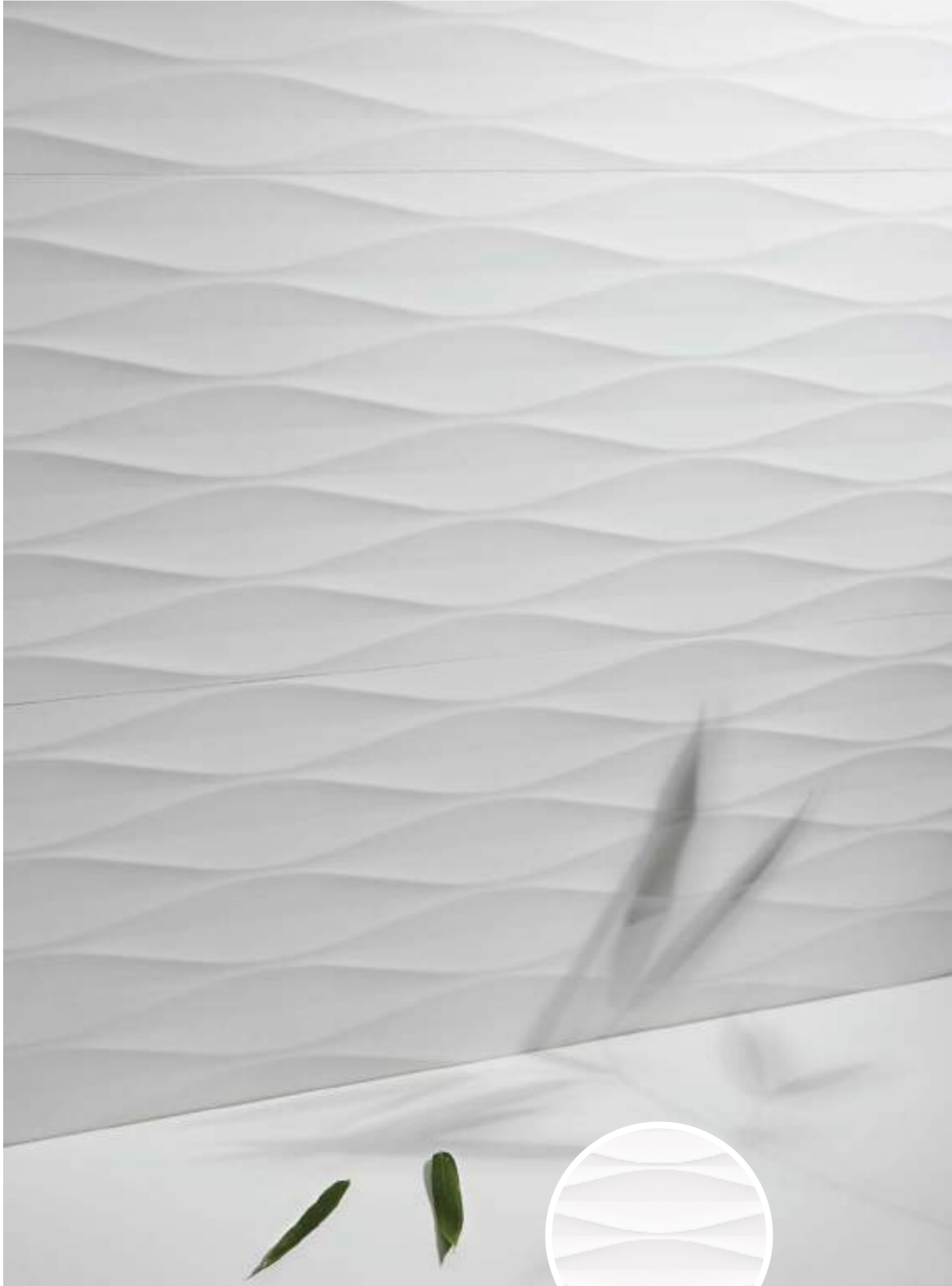

Cotton
Diamond_33,3*100



Cotton
Fold_33,3*100

Cotton



Cotton
Waves_33,3*100

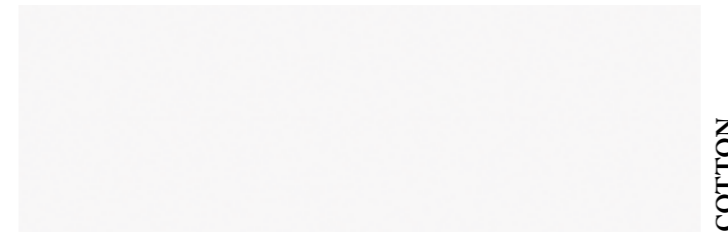

COTTON



COTTON Waves

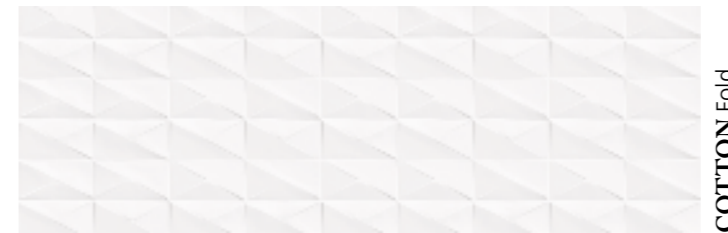

COTTON Fold



COTTON Diamond

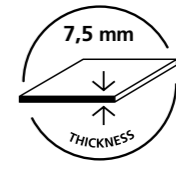

COTTON



33,3 * 100 * 0,75 cm | 13 * 39"

RECTIFIED	EXTRA WHITE
	BN4
COTTON	30852

COTTON FOLD

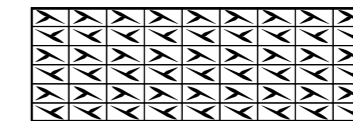

33,3 * 100 * 0,86 cm | 13 * 39"

RECTIFIED	EXTRA WHITE
	BN5
FOLD	30855

COTTON WAVES



33,3 * 100 * 0,86 cm | 13 * 39"

RECTIFIED	EXTRA WHITE
	BN5
WAVES	30856

COTTON DIAMOND

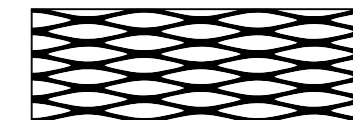

33,3 * 100 * 0,86 cm | 13 * 39"

RECTIFIED	EXTRA WHITE
	BN5
DIAMOND	30854

CARACTERÍSTICAS TÉCNICAS | TECHNICAL CHARACTERISTICS

joint	wall tiles	matt	thickness



PACKING + INFO | Pag. 264

Cotton



Danubio-H Vosgos-H
Aluminio/90



DANUBIO G



VOSGOS G



DANUBIO H



VOSGOS H

DANUBIO



32 * 90 * 1,05 cm | 13 * 36" 33 * 91 * 1,05 cm | 13 * 36"

RECTIFIED	NATURAL	NO RECTIFIED (joint 1,5 mm)	NATURAL
	BN29	BN21	
G	14430	G	14364
H	14431	H	14365



26200 ALUMINIO/90/MAT _ 90 * 0,5 cm | 35 * 0,2" _ P39



07021 ACERO/90 _ 1,5 * 90 cm | 0,6 * 36" _ P30

VOSGOS



32 * 90 * 1,05 cm | 13 * 36" 33 * 91 * 1,05 cm | 13 * 36"

RECTIFIED	NATURAL	NO RECTIFIED (joint 1,5 mm)	NATURAL
	BN36	BN25	
G	14432	G	14406
H	14433	H	14405



07605 ALUMINIO/90 _ 0,5 * 90 cm | 0,2 * 36" _ P39



26201 L. GOLDEN/MAT/90 _ 90 * 0,5 cm | 35 * 0,2" _ P39

CARACTERÍSTICAS TÉCNICAS | TECHNICAL CHARACTERISTICS

joint	wall tiles	matt	diferent shades	shade variation	various graphics



PACKING + INFO | Pag. 264

Danubio



Donna Sand
Decor_33,3*100

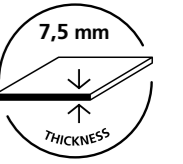

DONNA

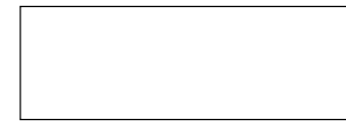

25 patterns

33,3 * 100 * 0,75 cm 13 * 39"	
RECTIFIED	NATURAL
	BN65
SAND	27534
SILVER	27535
WHITE	27536

DONNA DECOR

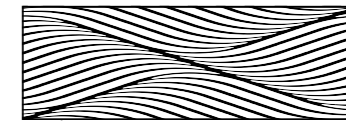

25 patterns

33,3 * 100 * 0,86 cm 13 * 39"	
RECTIFIED	NATURAL
	BN66
SAND	27539
SILVER	27538
WHITE	27537

***D. DONNA LEAVES**



33,3 * 100 * 0,75 cm 13 * 39"	
RECTIFIED	NATURAL
	P77
WHITE	27776

* Se comercializan en conjuntos de 2 piezas. Precio por pieza individual. They are sold in groups of 2 pieces. Price to the individual piece.



22303 ALUMINIO/100/MAT _ 100 * 0,5 cm | 39 * 0,2" _ P42

26153 L. GOLDEN/MAT/100 _ 100 * 0,5 cm | 39 * 0,2" _ P42

WallPEC	100 * 180 cm 39 * 71"
SHAPED	
WALLPE3C2	

CARACTERÍSTICAS TÉCNICAS TECHNICAL CHARACTERISTICS			
joint	wall tiles	matt	thickness
0,5 mm			7,5 mm



PACKING + INFO | Pag. 264

Donna

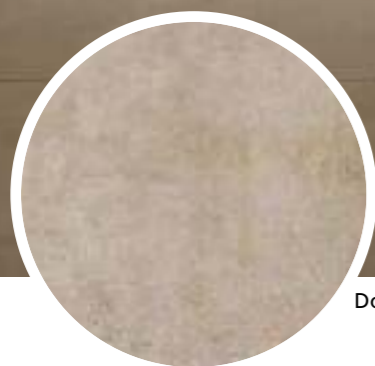

Downtown Beige_33,3*100 SP
Downtown Beige_90*90 SP
Lenk Walnut 19,5*121,5 AS



Downtown Material
Beige_33,3*100 SP

Downtown wall

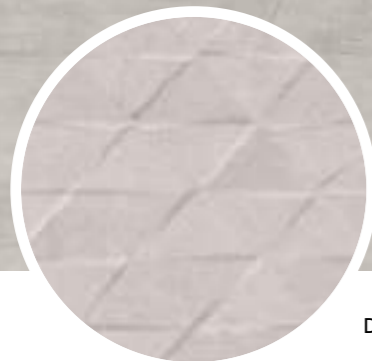

Downtown Grey_33,3*100 SP
Downtown Triangle Grey_33,3*100 SP
Downtown Grey_60*60

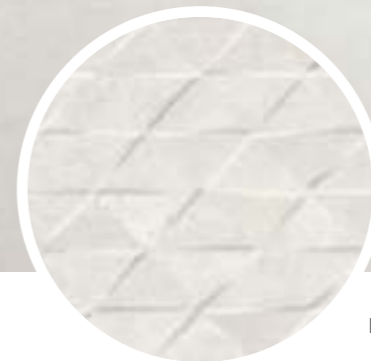

Downtown Triangle
White_33,3*100 SP

Downtown wall



DOWNTOWN
White



DOWNTOWN
White Triangle



DOWNTOWN
Beige



DOWNTOWN
Beige Triangle



DOWNTOWN
Grey



DOWNTOWN
Grey Triangle

DOWNTOWN



14 patterns

33,3 * 100 * 0,75 cm | 13 * 39"

RECTIFIED	SHAPED
	BN8
BEIGE	29725
GREY	29724
WHITE	29723

DOWNTOWN TRIANGLE

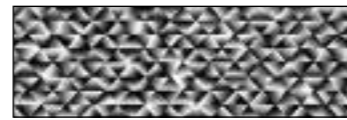

7 patterns

33,3 * 100 * 0,86 cm | 13 * 39"

RECTIFIED	SHAPED
	BN10
BEIGE	29727
GREY	29726
WHITE	29728

MATCHING FLOOR COLLECTIONS
DOWNTOWN_PORCELAIN | Pag. 77



DOWNTOWN
White Material



DOWNTOWN
Beige Material



DOWNTOWN
Grey Material

DOWNTOWN MATERIAL

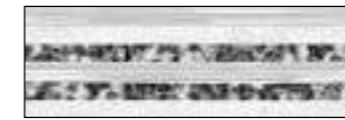

7 patterns

33,3 * 100 * 0,86 cm | 13 * 39"

RECTIFIED	SHAPED
	BN10
BEIGE	30754
GREY	30756
WHITE	30755

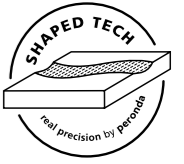
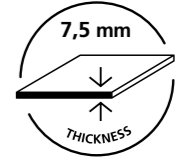

DOWNTOWN FLOOR



DOWNTOWN
White



DOWNTOWN
Beige



DOWNTOWN
Grey



DOWNTOWN
Anthracite

DOWNTOWN FLOOR

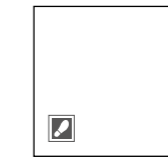

26 patterns

60 * 60 * 1 cm | 24 * 24"

RECTIFIED	NATURAL
	BN33
ANTHRACITE	29698
BEIGE	29700
GREY	29699
WHITE	29689

CARACTERÍSTICAS TÉCNICAS | TECHNICAL CHARACTERISTICS

joint	wall tiles	mat	diferent shades	shade variation	various graphics



PACKING + INFO | Pag. 264

Downtown wall



Erta Beige Decor
Erta Beige_25*75

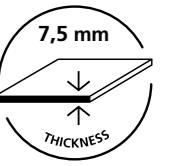

ERTA Beige



ERTA Beige | Decor



ERTA Silver



ERTA Silver | Decor

ERTA



12 patterns



12 patterns

33,3 * 100 * 0,75 cm | 13 * 39"

RECTIFIED	NATURAL
	BN65

BEIGE 22122

SILVER 22124

25 * 75 * 1,05 cm | 10 * 30"

NO RECTIFIED (joint 1,5 mm)	NATURAL
	BN16

BEIGE 21842

SILVER 21843



22303 ALUMINIO/100/MAT _ 100 * 0,5 cm | 39 * 0,2" _ P42

ERTA DECOR

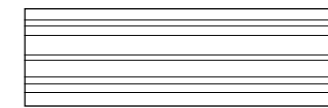

6 patterns

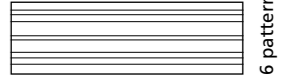

6 patterns

33,3 * 100 * 0,75 cm | 13 * 39"

RECTIFIED	NATURAL
	BN66

BEIGE 22123

SILVER 22125

25 * 75 * 1,05 cm | 10 * 30"

NO RECTIFIED (joint 1,5 mm)	NATURAL
	BN20

BEIGE 21841

SILVER 21840



26153 L. GOLDEN/MAT/100 _ 100 * 0,5 cm | 39 * 0,2" _ P42

CARACTERÍSTICAS TÉCNICAS | TECHNICAL CHARACTERISTICS

joint	wall tiles	matt	diferent shades	shade variation	various graphics



PACKING + INFO | Pag. 264

Erta



Frozen Lined-W Essence Nut



Tycho-W Frozen-W90 Shark S_90x90



Frozen Mosaic-W_100

Frozen

33,3 * 100 cm | 13 * 39"

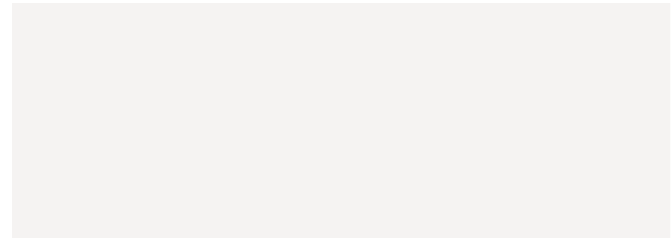
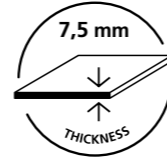

FROZEN W

FROZEN

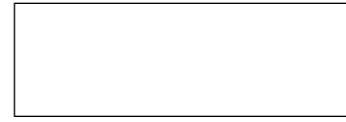

33,3 * 100 * 0,75 cm | 13 * 39"

RECTIFIED	NATURAL
	BN65
W	20585



FROZEN W | Lined

FROZEN LINED

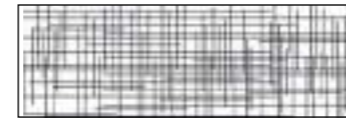

33,3 * 100 * 0,75 cm | 13 * 39"

RECTIFIED	NATURAL
	BN66
W	22305

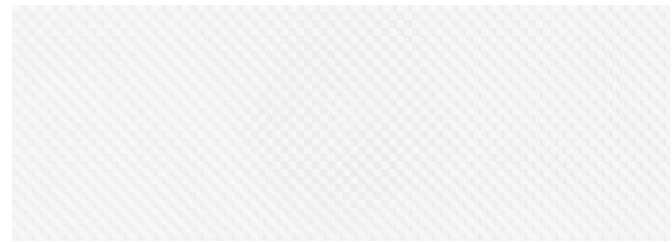

FROZEN W | Mosaic

FROZEN MOSAIC

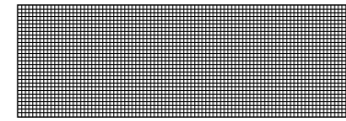

33,3 * 100 * 0,75 cm | 13 * 39"

RECTIFIED	NATURAL
	BN66
W	21372



22245 ALUMINIO/100 _ 100*0,5 cm | 39 * 0,2" _ P42



26153 L. GOLDEN/MAT/100 _ 100 * 0,5 cm | 39 * 0,2" _ P42

WallPEC	33,3 * 100 cm 13 * 39"
	NATURAL
FROZEN-W	WALLPE3C2

CARACTERÍSTICAS TÉCNICAS | TECHNICAL CHARACTERISTICS

joint	wall tiles	gloss	thickness

WallPEC	32 * 90 cm 13 * 36"
	NATURAL
FROZEN-W	WALLPE3C2

CARACTERÍSTICAS TÉCNICAS | TECHNICAL CHARACTERISTICS

joint	wall tiles	gloss



PACKING + INFO | Pag. 264

32 * 90 cm | 13 * 36"

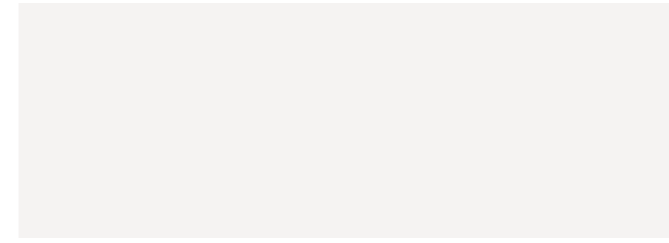

FROZEN W

FROZEN



32 * 90 * 1,05 cm | 13 * 36"

RECTIFIED	NATURAL
	BN29
W	17393

33 * 91 * 1,05 cm | 13 * 36"

NO RECTIFIED (joint 1,5 mm)	NATURAL
	BN21
W	17131



TYCHO W

TYCHO

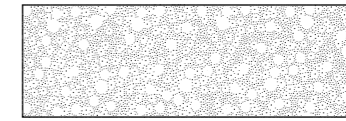

32 * 90 * 1,05 cm | 13 * 36"

RECTIFIED	NATURAL
	BN36
W	19868

33 * 91 * 1,05 cm | 13 * 36"

NO RECTIFIED (joint 1,5 mm)	NATURAL
	BN25
W	19397



20347 L. IRON ANTHRACITE _ 1,5 * 90 cm | 0,6 * 36" _ P38



17317 L. NORIAN-N/90/R _ 0,8 * 90 cm | 0,3 * 36" _ P32



20348 L. IRON MOCCHA _ 1,5 * 90 cm | 0,6 * 36" _ P38



07021 ACERO/90 _ 1,5 * 90 cm | 0,6 * 36" _ P30

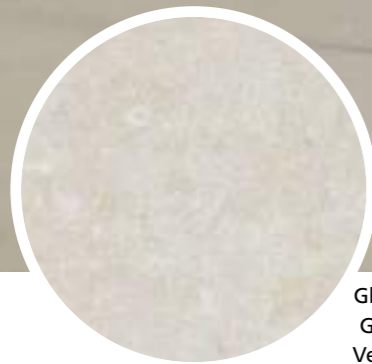

Ghent Beige_33,3*100 SP
Ghent Beige_100*100 SP
Verbier Taupe_24*151 AS



Ghent Beige Decor
_33,3*100 SP

Ghent wall



Ghent Decor
White_33,3*100 SP

MATCHING FLOOR COLLECTIONS
GHENT_PORCELAIN | Pag. 87

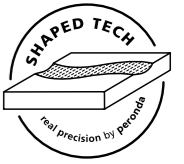
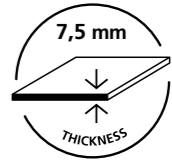

GHENT White



GHENT Beige



GHENT Silver



GHENT White decor



GHENT Beige decor



GHENT Silver decor

GHENT wall

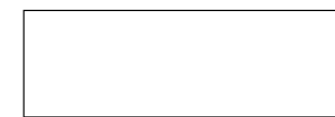

12 patterns

33,3 * 100 * 0,75 cm | 13 * 39"

RECTIFIED	SHAPED
	BN8
BEIGE	31860
SILVER	31862
WHITE	31861

GHENT DECOR

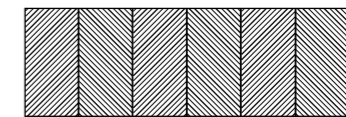

5 patterns

33,3 * 100 * 0,86 cm | 13 * 39"

RECTIFIED	SHAPED
	BN10
BEIGE	31863
SILVER	31864
WHITE	31865

PORCELAIN

GHENT floor



20 patterns

60 * 60 * 1 cm | 24 * 24"

RECTIFIED	NATURAL
	BN33
BEIGE	31755
GREY	31756
SILVER	31757
WHITE	31754



Beige



Silver



Grey

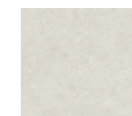

White

CARACTERÍSTICAS TÉCNICAS | TECHNICAL CHARACTERISTICS

joint	wall tiles	matt	diferent shades	shade variation	various graphics	thickness
0,5 mm				V2		7,5 mm



PACKING + INFO | Pag. 264

Ghent wall



Granier decor
Natural_33,3*100 SP



Granier decor
Taupe_33,3*100 SP

Granier wall



Granier decor
Honey_33,3*100 SP

MATCHING FLOOR COLLECTIONS
GRANIER_PORCELAIN | Pag. 91



GRANIER wall

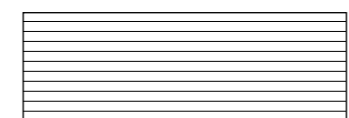

33,3 * 100 * 0,86 cm | 13 * 39"

RECTIFIED	SHAPED
	BN10
HONEY	34773
NATURAL	34772
TAUPE	34774

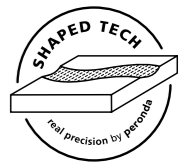
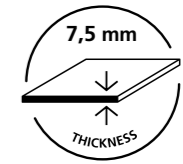

GRANIER FLOOR

PORCELAIN



GRANIER FLOOR

PORCELAIN

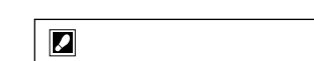

24 * 151 * 1 cm | 9 * 59"

RECTIFIED	ALL IN ONE
	BN121
ASH	34641
HONEY	34637
MAPLE	34639
NATURAL	34638
TAUPE	34640

CARACTERÍSTICAS TÉCNICAS | TECHNICAL CHARACTERISTICS

joint	wall tiles	matt	thickness	diferent shades	shade variation	various graphics



PACKING + INFO | Pag. 264

Granier wall



Ground
Bone_33,3*100



Ground Bone
decor_33,3*100

Ground wall



Ground
Silver_32*90

MATCHING FLOOR COLLECTIONS
GROUND_PORCELAIN | Pag. 101

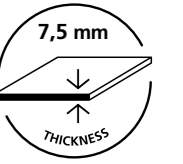

GROUND White



GROUND Silver



GROUND Bone



GROUND White
decor



GROUND Silver
decor



GROUND Bone
decor

GROUND



15 patterns

33,3 * 100 * 0,75 cm | 13 * 39"

RECTIFIED	NATURAL
	BN65
BONE	34761
SILVER	34762
WHITE	34763

GROUND DECOR

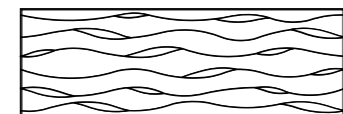

15 patterns

33,3 * 100 * 0,86 cm | 13 * 39"

RECTIFIED	NATURAL
	BN66
BONE	34813
SILVER	34815
WHITE	34814

GROUND FLOOR



30 patterns

60 * 60 * 1 cm | 24 * 24"

RECTIFIED	SOFT
	BN33
BONE	24936
GREY	24937
SILVER	24938



PORCELAIN

CARACTERÍSTICAS TÉCNICAS | TECHNICAL CHARACTERISTICS

joint	wall tiles	matt	thickness	diferent shades	shade variation	various graphics



PACKING + INFO | Pag. 264

Ground wall



Grunge Beige
Stripes_32*90



Grunge Beige
Stripes_32*90



Grunge
Beige_60*60 AS

Grunge wall



Grunge White
Stripe_32*90



Grunge beige
Peak_32*90

Grunge wall

32 * 90 cm | 13 * 36"

White body tiles



GRUNGE White



GRUNGE White Peak



GRUNGE Beige



GRUNGE Beige Peak



GRUNGE Grey

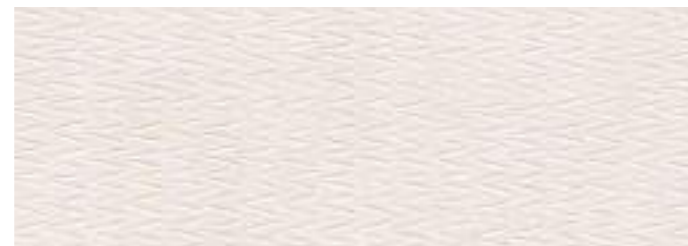

GRUNGE Grey Peak



GRUNGE White Stripes

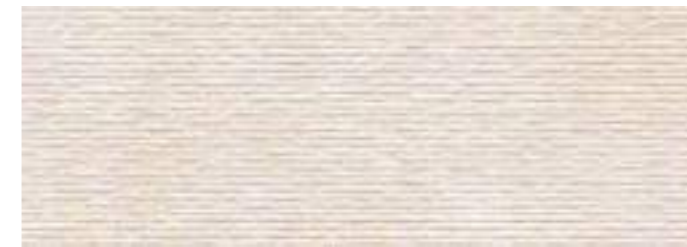

GRUNGE Beige Stripes



GRUNGE Grey Stripes

GRUNGE FLOOR

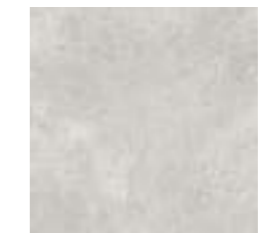

GRUNGE White

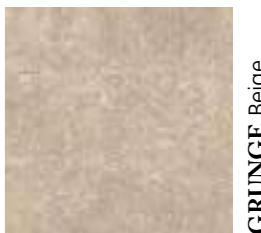

GRUNGE Beige



GRUNGE Grey



GRUNGE Anthracite

GRUNGE wall



16 patterns

32 * 90 * 1,05 cm | 13 * 36"

RECTIFIED	NATURAL
	BN29
WHITE	27490
BEIGE	27491
GREY	27492

GRUNGE PEAK

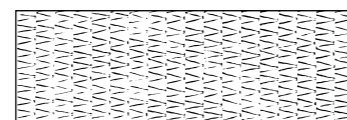

16 patterns

32 * 90 * 1,05 cm | 13 * 36"

RECTIFIED	NATURAL
	BN36
WHITE	27497
BEIGE	27498
GREY	27496

GRUNGE STRIPES

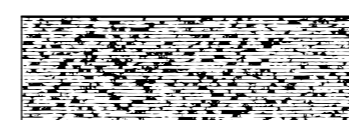

16 patterns

32 * 90 * 1,05 cm | 13 * 36"

RECTIFIED	NATURAL
	BN36
WHITE	27495
BEIGE	27493
GREY	27494

GRUNGE floor

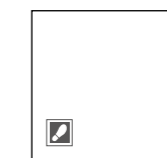

30 patterns

60 * 60 * 1 cm | 24 * 24"

RECTIFIED	ALL IN ONE
	BN88
ANTHRACITE	27409
BEIGE	27410
GREY	27411
WHITE	27408

D. GRUNGE WALL MOSAIC

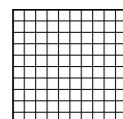

30 * 30 cm | 12 * 12"

NO RECTIFIED	NATURAL
	P44
WHITE	27612
BEIGE	27613
GREY	27614



07021 ACERO/90 _ 1,5 * 90 cm | 0,6 * 36 _ P30

20347 L. IRON ANTHRACITE _ 1,5 * 90 cm | 0,6 * 36" _ P38

20348 L. IRON MOCCHA _ 1,5 * 90 cm | 0,6 * 36" _ P38

07605 ALUMINIO/90 _ 0,5 * 90 cm | 0,2 * 36 _ P39

CARACTERÍSTICAS TÉCNICAS | TECHNICAL CHARACTERISTICS

joint	wall tiles	matt	diferent shades	shade variation	various graphics



PACKING + INFO | Pag. 264

Grunge wall



25 * 75 cm | 10 * 30"



GRUNGE White



GRUNGE Beige



GRUNGE Grey



GRUNGE White decor



GRUNGE Beige decor



GRUNGE Grey decor

GRUNGE



20 patterns

25 * 75 * 1,05 cm | 10 * 30"

NO RECTIFIED	NATURAL
	BN16
WHITE	27156
BEIGE	27158
GREY	27157

GRUNGE DECOR

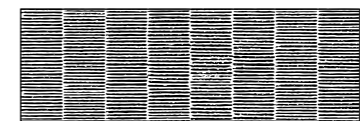

7 patterns

25 * 75 * 1,05 cm | 10 * 30"

NO RECTIFIED	NATURAL
	BN20
WHITE	27161
BEIGE	27159
GREY	27160

D. GRUNGE WALL MOSAIC

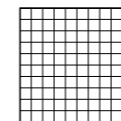

30 * 30 cm | 12 * 12"

NO RECTIFIED	NATURAL
	P44
WHITE	27612
BEIGE	27613
GREY	27614

11899 ALUMINIO/75 _ 0,5 * 75 cm | 0,2 * 30" _ P36

20345 L. IRON SNUFF _ 1 * 75 cm | 0,4 * 30" _ P35

20346 L. IRON NATURAL _ 1 * 75 cm | 0,4 * 30" _ P35

CARACTERÍSTICAS TÉCNICAS | TECHNICAL CHARACTERISTICS

joint	wall tiles	matt	diferent shades	shade variation	various graphics

Grunge Grey Decor_25*75



PACKING + INFO | Pag. 264

Grunge wall



Downtown
Anthracite_100*100 SP

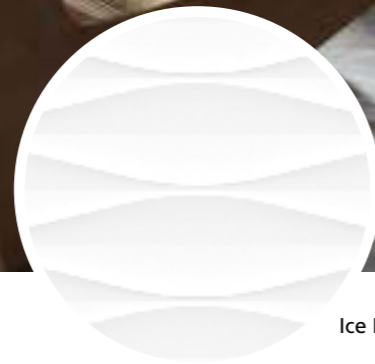

Ice Diamond_33,3*100
Ice_33,3*100



Ice Fold_33,3*100
Ice_33,3*100



Ice Waves_33,3*100

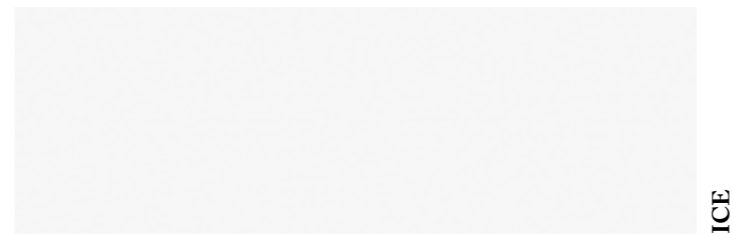
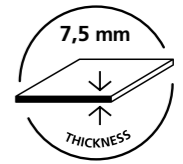

ICE

ICE



33,3 * 100 * 0,75 cm | 13 * 39"

RECTIFIED	EXTRA WHITE
	BN4
COTTON	30853



ICE Waves

ICE FOLD

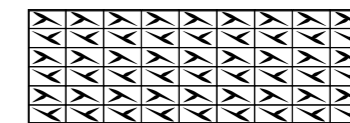

33,3 * 100 * 0,86 cm | 13 * 39"

RECTIFIED	EXTRA WHITE
	BN5
FOLD	30859

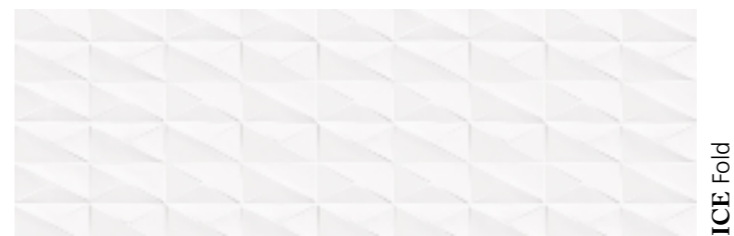

ICE Fold

ICE WAVES



33,3 * 100 * 0,86 cm | 13 * 39"

RECTIFIED	EXTRA WHITE
	BN5
WAVES	30857



ICE Diamond

ICE DIAMOND

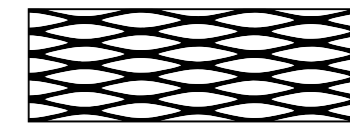

33,3 * 100 * 0,86 cm | 13 * 39"

RECTIFIED	EXTRA WHITE
	BN5
DIAMOND	30858

CARACTERÍSTICAS TÉCNICAS | TECHNICAL CHARACTERISTICS

joint	wall tiles	gloss	thickness



PACKING

+ INFO | Pag. 264

Ice



Laccio Cement-G
Shark-S_90*90



LACCIO Cement-H



LACCIO Wood-H



LACCIO Cement-G



LACCIO Wood-G



LACCIO W

LACCIO

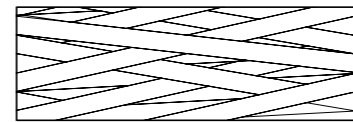

Cement/ Wood_4 patterns
W_1 patterns

32 * 90 * 1,05 cm | 13 * 36"

RECTIFIED	NATURAL
	BN36
CEMENT-H	18502
CEMENT-G	18503
WOOD-H	18500
WOOD-G	18501
W	18158



07605 ALUMINIO/90 _ 0,5 * 90 cm | 0,2 * 36" _ P39



07021 ACERO/90 _ 1,5 * 90 cm | 0,6 * 36" _ P30



26201 L. GOLDEN/MAT/90 _ 90 * 0,5 cm | 35 * 0,2" _ P39

CARACTERÍSTICAS TÉCNICAS | TECHNICAL CHARACTERISTICS

joint	wall tiles	matt	diferent shades	shade variation	various graphics



PACKING + INFO | Pag. 260

Laccio



Lucca Beige_33,3*100 SP
Lucca Beige_90*90 AS



Lucca Decor
Beige_33,3*100 SP

Lucca wall

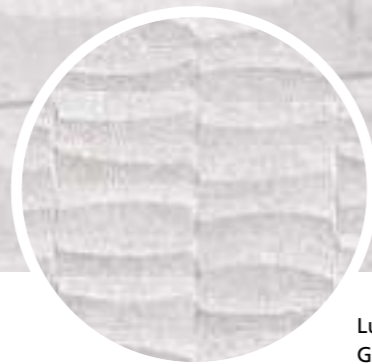

Lucca Decor
Grey_33,3*100 SP

MATCHING FLOOR COLLECTIONS
LUCCA_PORCELAIN | Pag. 123

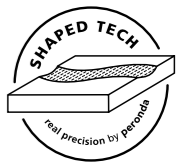
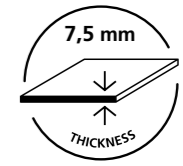

LUCCA White

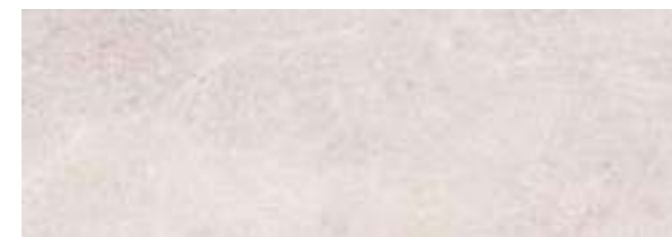

LUCCA Beige



LUCCA Grey



LUCCA White decor



LUCCA Beige decor



LUCCA Grey decor

LUCCA wall



21 patterns

33,3 * 100 * 0,75 cm | 13 * 39"

RECTIFIED	SHAPED
	BN8
WHITE	31789
BEIGE	31791
GREY	31790

LUCCA DECOR

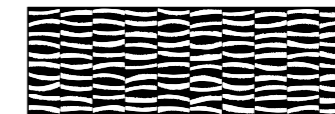

5 patterns

33,3 * 100 * 0,86 cm | 13 * 39"

RECTIFIED	SHAPED
	BN10
WHITE	31792
BEIGE	31794
GREY	31793

LUCCA floor

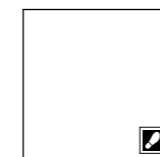

20 patterns

60 * 60 * 1 cm | 24 * 24"

RECTIFIED	NATURAL
	BN33
ANTHRACITE	31354
BEIGE	31355
GREY	31356
WHITE	31357



Anthracite



Beige



Grey



White

PORCELAIN

CARACTERÍSTICAS TÉCNICAS | TECHNICAL CHARACTERISTICS

joint	wall tiles	matt	diferent shades	shade variation	various graphics	thickness



PACKING + INFO | Pag. 260

Lucca wall



Manhattan
Bone_33,3*100 SP



Manhattan Bone
Wavy_33,3*100 SP

Manhattan wall



Manhattan
Bone_33,3*100 SP

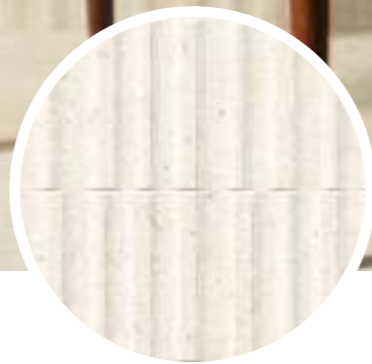

Manhattan Bone
Wavy_33,3*100 SP



Manhattan White
Lines_33,3*100 SP

Manhattan wall



MANHATTAN
White



MANHATTAN
White Wavy



MANHATTAN
Bone



MANHATTAN
Bone Wavy



MANHATTAN
Silver



MANHATTAN
Silver Wavy

MANHATTAN



14 patterns

33,3 * 100 * 0,75 cm | 13 * 39"

RECTIFIED	SHAPED
	BN8
BONE	34752
SILVER	34753
WHITE	34754

MANHATTAN WAVY



14 patterns

33,3 * 100 * 0,86 cm | 13 * 39"

RECTIFIED	SHAPED
	BN10
BEIGE	34758
GREY	34756
WHITE	34760

MATCHING FLOOR COLLECTIONS
MANHATTAN_PORCELAIN | Pag. 133



MANHATTAN
White Lines



MANHATTAN
Bone Lines



MANHATTAN
Silver Lines

MANHATTAN LINES



14 patterns

33,3 * 100 * 0,86 cm | 13 * 39"

RECTIFIED	SHAPED
	BN10
BEIGE	34757
GREY	34755
WHITE	34759

MANHATTAN floor



White



Bone

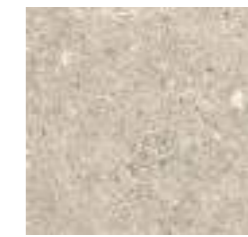

Silver



Grey

MANHATTAN floor



24 patterns

60 * 60 * 1 cm | 24 * 24"

RECTIFIED	ALL IN ONE
	BN88
BONE	34750
GREY	34749
SILVER	34751
WHITE	34873

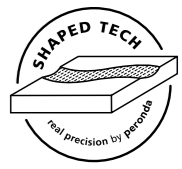
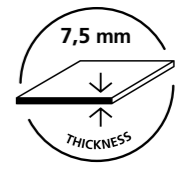

CARACTERÍSTICAS TÉCNICAS | TECHNICAL CHARACTERISTICS

joint	wall tiles	matt	diferent shades	shade variation	various graphics



PACKING + INFO | Pag. 260

Manhattan wall



Mitte-W_25*75

Noah Alex-W



MITTE W



MITTE G



WILMA



ALEX W



ALEX G



NOAH

MITTE



24 patterns

25 * 75 * 1,05 cm | 10 * 30"

NO RECTIFIED	NATURAL
	BN16
W	20172
G	20171

WILMA

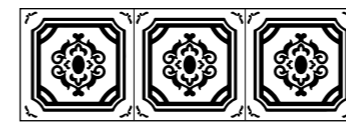

6 patterns

25 * 75 * 1,05 cm | 10 * 30"

NO RECTIFIED	NATURAL
	BN20
WILMA	20176

ALEX

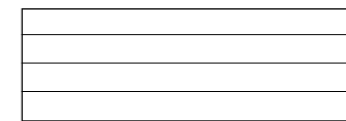

6 patterns

25 * 75 * 1,05 cm | 10 * 30"

NO RECTIFIED	NATURAL
	BN20
W	20174
G	20173

NOAH

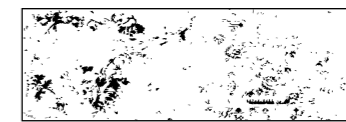

7 patterns

25 * 75 * 1,05 cm | 10 * 30"

NO RECTIFIED	NATURAL
	BN20
NOAH	20175



20345 L. IRON SNUFF _ 1 * 75 cm | 0,4 * 30" _ P35

20346 L. IRON NATURAL _ 1 * 75 cm | 0,4 * 30" _ P35

11899 ALUMINIO/75 _ 0,5 * 75 cm | 0,2 * 30" _ P36



26199 L. GOLDEN/75/MAT _ 0,5 * 75 cm | 0,2 * 30" _ P36

CARACTERÍSTICAS TÉCNICAS | TECHNICAL CHARACTERISTICS

joint	wall tiles	matt	diferent shades	shade variation	various graphics



PACKING + INFO | Pag. 264

Mitte wall



Nature Sand_32*90

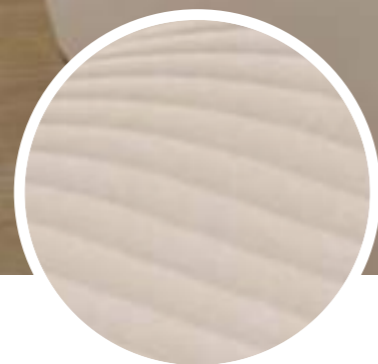

Nature Sand Decor_32*90

MATCHING FLOOR COLLECTIONS
NATURE_PORCELAIN | Pag. 145



NATURE Sand



NATURE Silver



NATURE White



NATURE Sand | Decor



NATURE Silver | Decor



NATURE White | Decor

NATURE wall



17 patterns

32 * 90 * 1,05 cm | 13 * 36"

RECTIFIED	NATURAL
	BN29
WHITE	26279
SAND	24028
SILVER	24027

NATURE DECOR



17 patterns

32 * 90 * 1,05 cm | 13 * 36"

RECTIFIED	NATURAL
	BN36
WHITE	26280
SAND	24029
SILVER	24030

NATURE floor

PORCELAIN

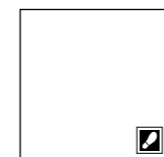

24 patterns

60 * 60 * 1 cm | 24 * 24"

RECTIFIED	SOFT
	BN33
WHITE	25764
GREY	25765
BEIGE	25766
ANTHRACITE	25767



White Grey



Beige Anth.

D. NATURE MOSAIC

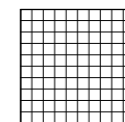

30 * 30 cm | 12 * 12"

NO RECTIFIED	NATURAL
	P44
WHITE	26299
SAND	30870
SILVER	30871

WallPEC	32 * 90 cm 13 * 36"
NATURE Wall	WALLPE3C2

CARACTERÍSTICAS TÉCNICAS | TECHNICAL CHARACTERISTICS

joint	wall tiles	matt	diferent shades	shade variation	various graphics



PACKING + INFO | Pag. 264

Nature wall



D.Palette Mosaic Blue
Urban Silver 90*90 A



Palette Blue
Palette Ash



PALETTE Ash



PALETTE Ecrú

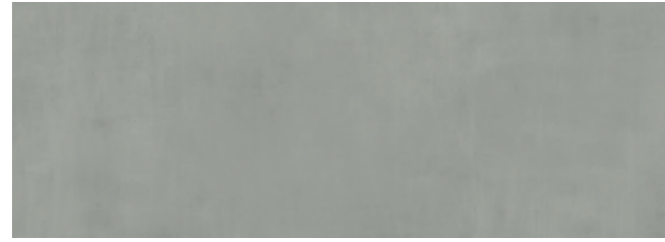

PALETTE Fog



PALETTE Taupe



PALETTE Blue



PALETTE Green



PALETTE Square Cold



PALETTE Square Warm



PALETTE Volute Cold



PALETTE Volute Warm



PALETTE Leaves Cold



PALETTE Leaves Warm

D.PALETTE MOSAIC



Ash

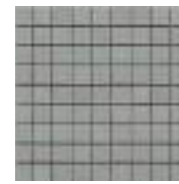

Fog



Blue

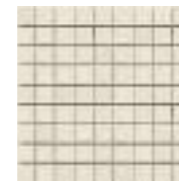

Ecrú



Taupe



Green

PALETTE

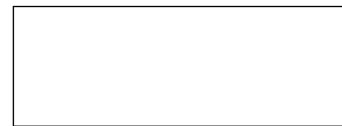

10 patterns

32 * 90 * 1,05 cm | 13 * 36"

RECTIFIED	NATURAL
	BN29
ASH	24402
BLUE	24403
ECRU	24405
FOG	24404
GREEN	24407
TAUPE	24406

D. PALETTE MOSAIC

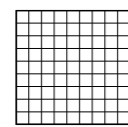

31,5 * 31,5 cm | 12 * 12"

NO RECTIFIED	NATURAL
	P56
ASH	26169
BLUE	26180
ECRU	26181
FOG	26182
GREEN	26183
TAUPE	26184

L. PALETTE



26163 L. PALETTE ASH _ 3 * 90 cm | 1 * 36" _ P38



26166 L. PALETTE FOG _ 3 * 90 cm | 1 * 36" _ P38



26164 L. PALETTE BLUE _ 3 * 90 cm | 1 * 36" _ P38



26165 L. PALETTE ECRU _ 3 * 90 cm | 1 * 36" _ P38



26168 L. PALETTE TAUPE _ 3 * 90 cm | 1 * 36" _ P38



26167 L. PALETTE GREEN _ 3 * 90 cm | 1 * 36" _ P38

PALETTE SQUARE

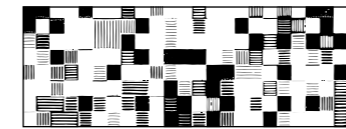

5 patterns

32 * 90 * 1,05 cm | 13 * 36"

RECTIFIED	NATURAL
	BN36
COLD	24493
WARM	24494



26200 ALUMINIO/90/MAT _ 90 * 0,5 cm | 35 * 0,2" _ P39

PALETTE VOLUTE

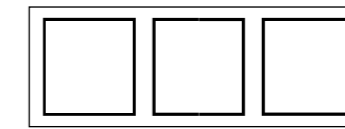

32 * 90 * 1,05 cm | 13 * 36"

RECTIFIED	NATURAL
	BN36
COLD	26156
WARM	26157



26201 L. GOLDEN/MAT/90 _ 90 * 0,5 cm | 35 * 0,2" _ P39

PALETTE LEAVES



32 * 90 * 1,05 cm | 13 * 36"

RECTIFIED	NATURAL
	BN36
COLD	26154
WARM	26155

CARACTERÍSTICAS TÉCNICAS | TECHNICAL CHARACTERISTICS

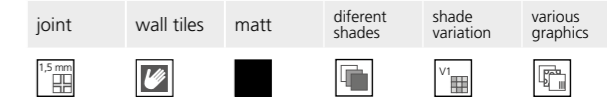

PACKING + INFO | Pag. 264

Palette

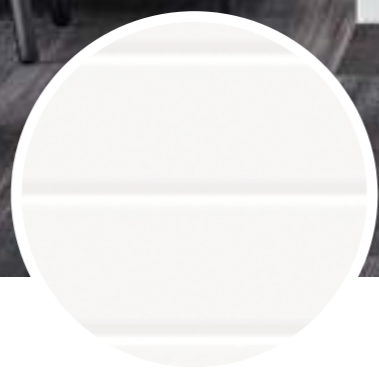

Pure White_25*75
Pure Decor Alex
White_25*75

Pure



Fiber-W
Fiber-G



Pure Striped

Pure

33,3 * 100 cm | 13 * 39"

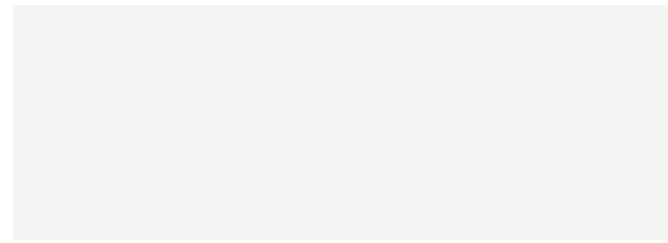
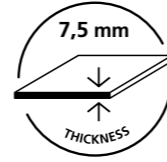

PURE W

PURE



33,3 * 100 * 0,75 cm | 13 * 39"

RECTIFIED	NATURAL
W	BN65
20586	



PURE Striped

PURE STRIPED



33,3 * 100 * 0,75 cm | 13 * 39"

RECTIFIED	NATURAL
PURE STRIPED	BN66
23169	

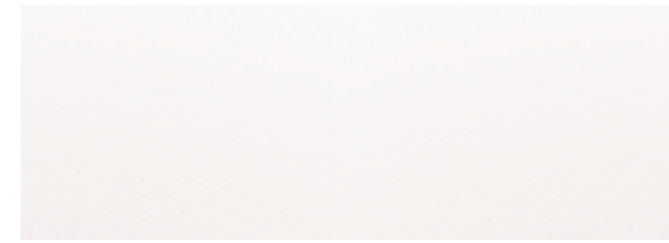

PURE W

PURE



32 * 90 * 1,05 cm | 13 * 36"

RECTIFIED	NATURAL
W	BN29
16159	

33 * 91 * 1,05 cm | 13 * 36"

NO RECTIFIED (joint 1,5 mm)	NATURAL
W	BN21
16150	



FIBER W

FIBER

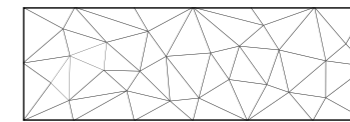

32 * 90 * 1,05 cm | 13 * 36"

RECTIFIED	NATURAL
W	BN36
16161	
G	16160

33 * 91 * 1,05 cm | 13 * 36"

NO RECTIFIED (joint 1,5 mm)	NATURAL
W	BN25
16153	
G	16151



FIBER G



22245 ALUMINIO/100 _ 100*0,5 cm | 39 * 0,2" _ P42



26153 L. GOLDEN/MAT/100 _ 100 * 0,5 cm | 39 * 0,2" _ P42



20347 L. IRON ANTHRACITE _ 1,5 * 90 cm | 0,6 * 36" _ P38



20348 L. IRON MOCCHA _ 1,5 * 90 cm | 0,6 * 36" _ P38



07021 ACERO/90 _ 1,5 * 90 cm | 0,6 * 36" _ P30



07605 ALUMINIO/90 _ 0,5 * 90 cm | 0,2 * 36" _ P39

WallPEC	33,3 * 100 cm 13 * 39"
PURE W	NATURAL WALLPE3C2

CARACTERÍSTICAS TÉCNICAS | TECHNICAL CHARACTERISTICS

joint	wall tiles	matt	thickness
0,5 mm			7,5 mm

WallPEC	32 * 90 cm 13 * 36"
PURE W	NATURAL WALLPE3C2

CARACTERÍSTICAS TÉCNICAS | TECHNICAL CHARACTERISTICS

joint	wall tiles	matt
0,5 mm		



PACKING + INFO | Pag. 264

Pure



Pure White Decor Smith_25*75
 Pure White_25*75 Mila Cold_60*60 SF

25 * 75 cm | 10 * 30"

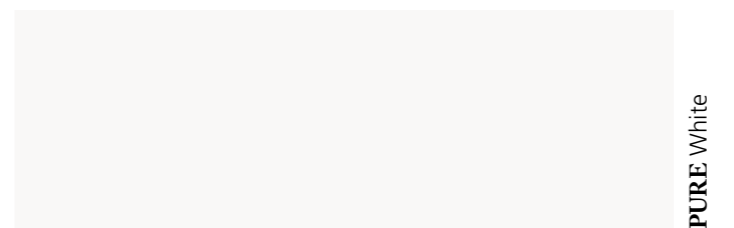

PURE White

PURE



25 * 75 * 1,05 cm | 10 * 30"

NO RECTIFIED	NATURAL
WHITE	BN16
	21786



PURE White | Decor Smith

PURE DECOR SMITH

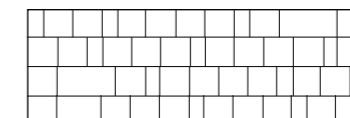

25 * 75 * 1,05 cm | 10 * 30"

NO RECTIFIED	NATURAL
WHITE	BN20
	21788



PURE White | Decor Alex

PURE DECOR ALEX

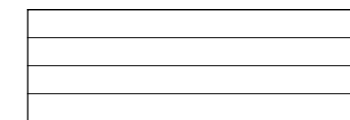

25 * 75 * 1,05 cm | 10 * 30"

NO RECTIFIED	NATURAL
WHITE	BN20
	21787



11899 ALUMINIO/75 _ 0,5 * 75 cm | 0,2 * 30" _ P36



20346 L. IRON NATURAL _ 1 * 75 cm | 0,4 * 30" _ P35



20345 L. IRON SNUFF _ 1 * 75 cm | 0,4 * 30" _ P35

CARACTERÍSTICAS TÉCNICAS | TECHNICAL CHARACTERISTICS

joint	wall tiles	matt



PACKING + INFO | Pag. 264

Pure

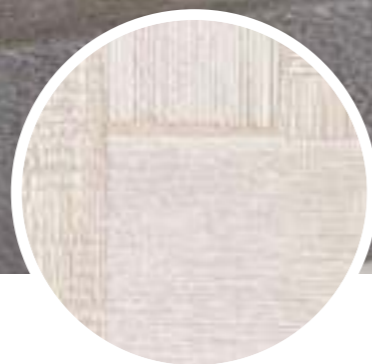

Salines Bone
Decor_100

Salines

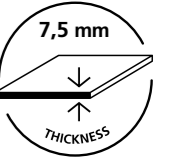

SALINES White



SALINES Bone



SALINES Silver



SALINES White | Decor



SALINES Bone | Decor



SALINES Silver | Decor



SALINES White | Waves



SALINES Bone | Waves



SALINES Silver | Waves

D.SALINES MOSAIC

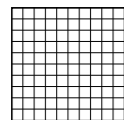

30 * 30 cm | 12 * 12"

NO RECTIFIED	NATURAL
	P44
WHITE	23321
BONE	23322
SILVER	23323
MIX	23320



22303 ALUMINIO/100/MAT _ 100 * 0,5 cm | 39 * 0,2" _ P42



26153 L. GOLDEN/MAT/100 _ 100 * 0,5 cm | 39 * 0,2" _ P42

SALINES

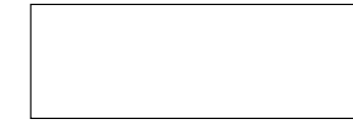

9 patterns

33,3 * 100 * 0,75 cm | 13 * 39"

RECTIFIED	NATURAL
	BN65
WHITE	23142
BONE	23136
SILVER	23143

SALINES DECOR

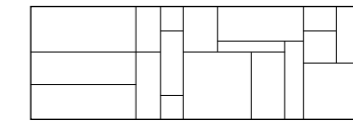

3 patterns

33,3 * 100 * 0,75 cm | 13 * 39"

RECTIFIED	NATURAL
	BN66
WHITE	23145
BONE	23144
SILVER	23146

SALINES WAVES

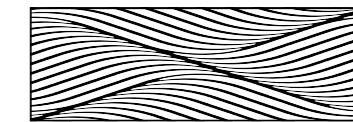

9 patterns

33,3 * 100 * 0,86 cm | 13 * 39"

RECTIFIED	NATURAL
	BN66
WHITE	31189
BONE	31188
SILVER	31190

CARACTERÍSTICAS TÉCNICAS | TECHNICAL CHARACTERISTICS

joint	wall tiles	matt	thickness



PACKING

+ INFO | Pag. 264

Salines



Verbier Honey
_19,5*121,5 AS



Verbier Honey
decor_33,3*100 SP

Verbier wall

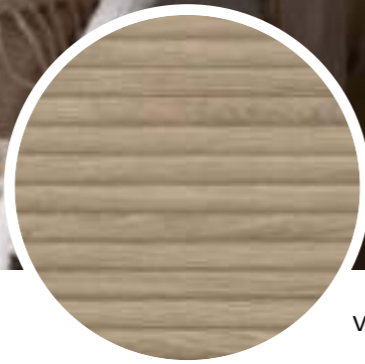

Verbier Taupe decor
_33,3*100 SP

MATCHING FLOOR COLLECTIONS
VERBIER_PORCELAIN | Pag. 159



VERBIER DECOR wall

<p>5 patterns</p>	33,3 * 100 * 0,86 cm 13 * 39"	
	RECTIFIED	SHAPED
		BN10
	HONEY	32893
	TAUPE	32892

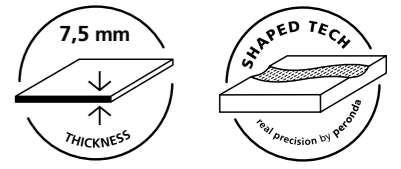

VERBIER floor PORCELAIN

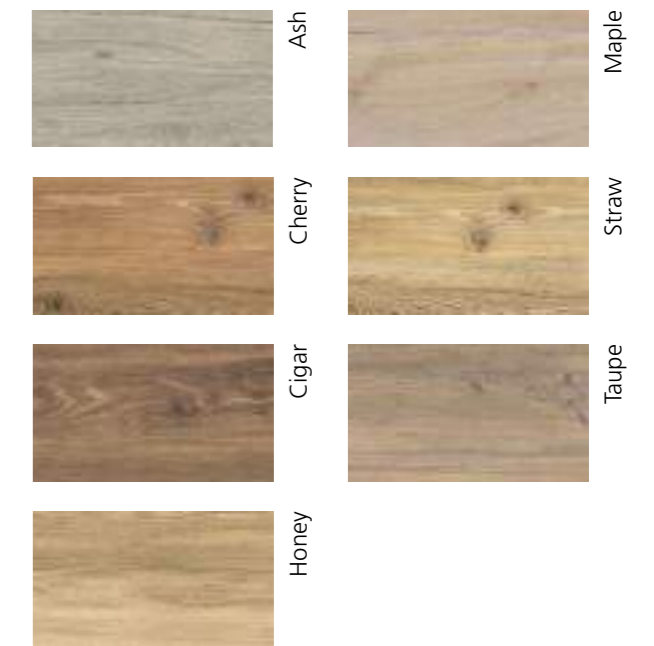

VERBIER floor PORCELAIN

<p>36 patterns</p>	24 * 151 * 1 cm 9 * 59"	
	RECTIFIED	ALL IN ONE
		BN121
	ASH	31730
	CHERRY	31599
	CIGAR	31601
	HONEY	31604
	MAPLE	31603
	STRAW	31600
	TAUPE	31602

CARACTERÍSTICAS TÉCNICAS | TECHNICAL CHARACTERISTICS

joint	wall tiles	matt	diferent shades	shade variation	various graphics	thickness



Verbier wall



Vibrato-H Spiccato-H
Mumble-C_15*90



VIBRATO G



VIBRATO H



TREMOLO G



TREMOLO H



SPICATTO G



SPICATTO H

VIBRATO

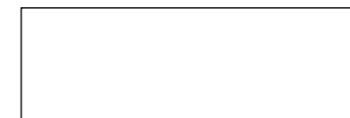

9 patterns

25 * 75 * 1,05 cm | 10 * 30"

NO RECTIFIED	NATURAL
G	BN16
H	19256
	19257

TREMOLO

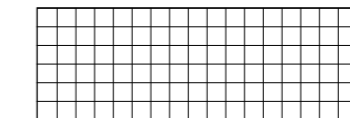

10 patterns

25 * 75 * 1,05 cm | 10 * 30"

NO RECTIFIED	NATURAL
G	BN20
H	19354
	19258

SPICATTO



9 patterns

25 * 75 * 1,05 cm | 10 * 30"

NO RECTIFIED	NATURAL
G	BN20
H	19355
	19259



26200 ALUMINIO/90/MAT _ 90 * 0,5 cm | 35 * 0,2" _ P39



26201 L. GOLDEN/MAT/90 _ 90 * 0,5 cm | 35 * 0,2" _ P39

WallPEC	25 * 75 cm 10 * 30"
NATURAL	
VIBRATO	WALLPE3C2

CARACTERÍSTICAS TÉCNICAS | TECHNICAL CHARACTERISTICS

joint	wall tiles	matt	diferent shades	shade variation	various graphics	thickness



PACKING + INFO | Pag. 264

Vibrato

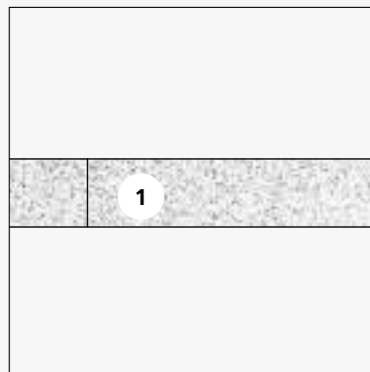

1

RODAPIE SKIRTING (R.)

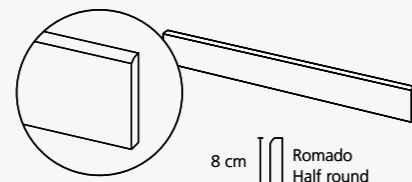

- 8 * 100 cm | 3 * 39" P45
- 8 * 60 cm | 3 * 24" P34
- 8 * 90 cm | 3 * 36" P44
- 8 * 60 cm | 3 * 24" P34

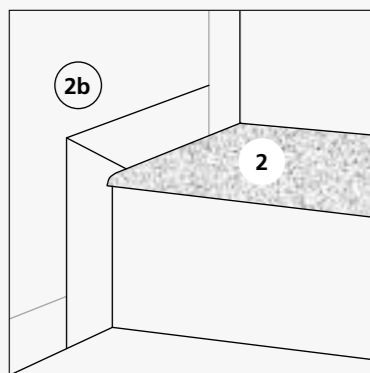

2

**PELDAÑO ROMO
ROUNDED STAIR - TREAD (PR.)**

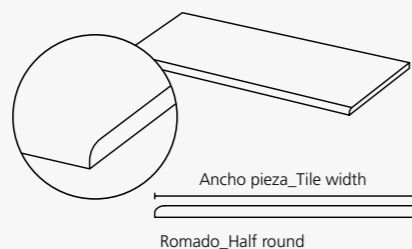

- 30 * 100 cm | 12 * 39" P85
- 30 * 60 cm | 12 * 24" P64
- 30 * 151 cm | 12 * 59" P54
- 30 * 120 cm | 12 * 48" P77
- 30 * 90 cm | 12 * 36" P61

2b

**ZANQUÍN ROMO
SKIRTING PIECES ROUNDED
STAIR-TREAD**

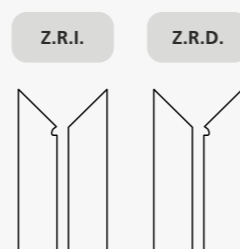

- 8*30 cm | 3 * 12" P55

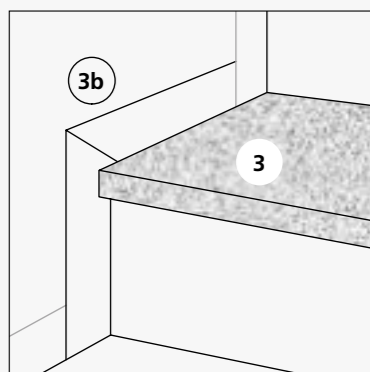

3

**PELDAÑO TÉCNICO DOBLE
DOUBLE TECHNICAL STAIR - TREAD (PT.)**

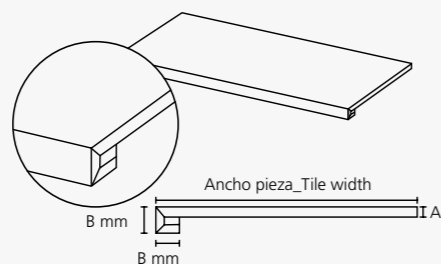

- 30 * 100 cm | 12 * 39" P74
- 30 * 151 cm | 12 * 59" P80
- 30 * 90 cm | 12 * 36" P76
- 30 * 60 cm | 12 * 24" P54
- 30 * 120 cm | 12 * 48" P75
- A = 0,6 cm B = 1,8 cm
- A = 0,8 cm B = 2,4 cm
- A = 1 cm B = 3 cm

3b

**ZANQUÍN ANGULAR
SKIRTING PIECES DOBLE TECHNICAL
STAIR-TREAD**

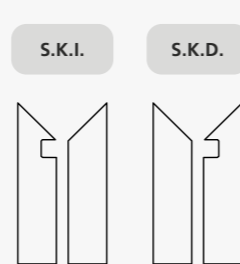

- 8*30 cm | 3 * 12" P55

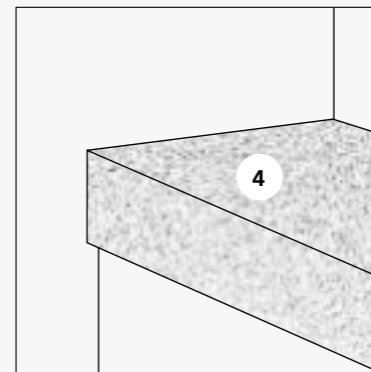

4

PELDAÑO TÉCNICO SIMPLE SEAMLESS TECHNICAL STAIR - TREAD (PL.)

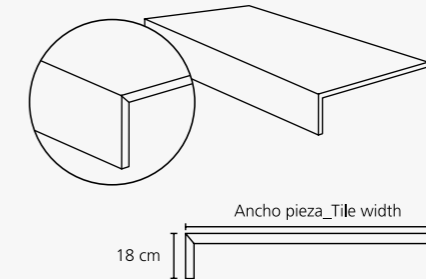

- 30 * 100 cm | 12 * 39" P74
- 30 * 151 cm | 12 * 59" P80
- 30 * 90 cm | 12 * 36" P76
- 30 * 60 cm | 12 * 24" P54
- 30 * 120 cm | 12 * 48" P75

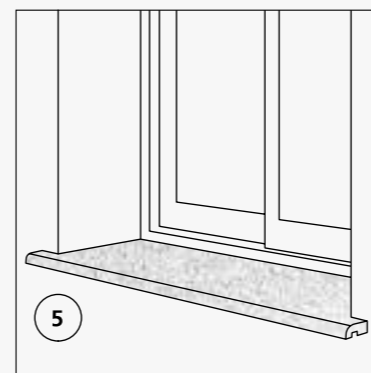

5

ALFÉIZAR WINDOWSILL (AF.)

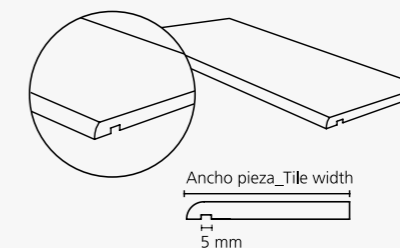

- 25*90 cm | 10*36" P77
- 25*120 cm | 10*48" P54

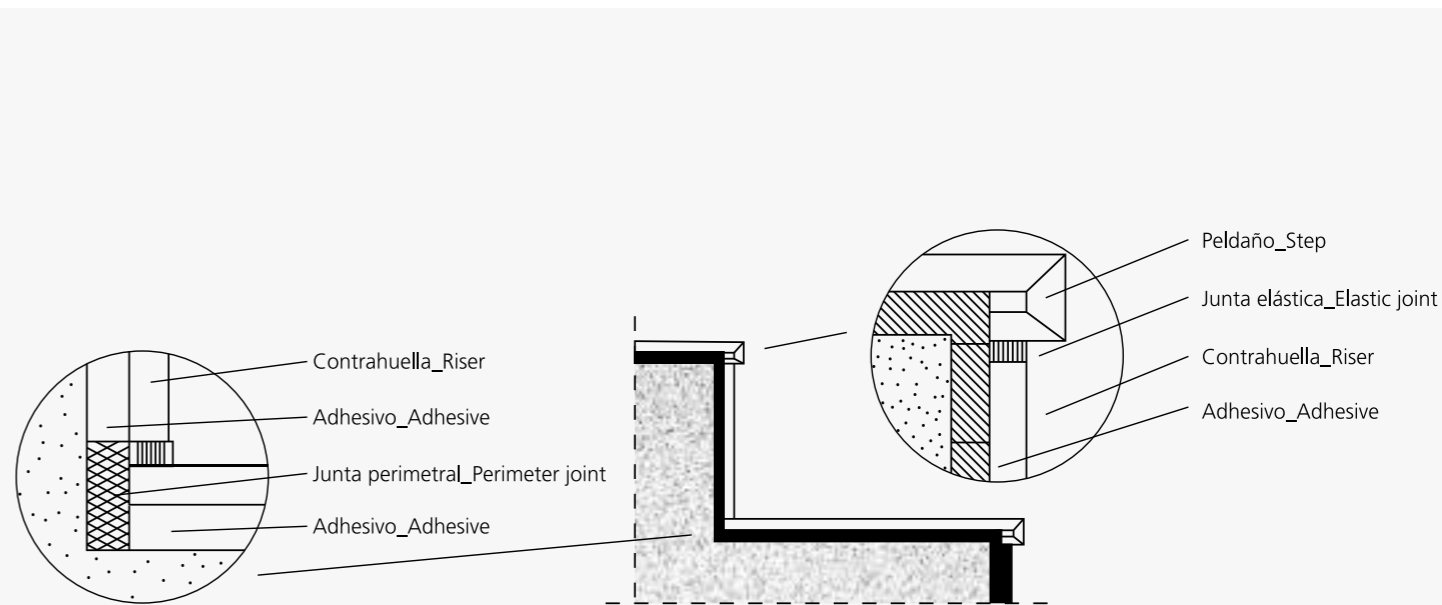

Detail of steps on a staircase (UNE 138002-2017)

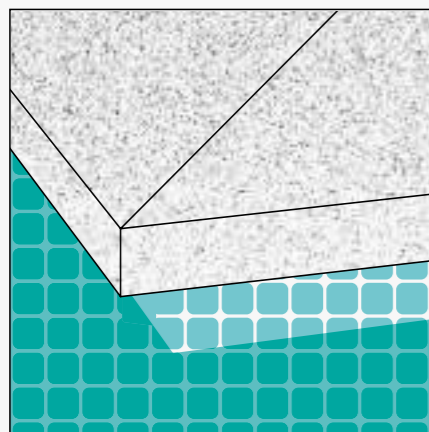

1 PELDAÑO VIERTEGUA ESQUINA POOL COPING EXTERNAL CORNER (EPV.)

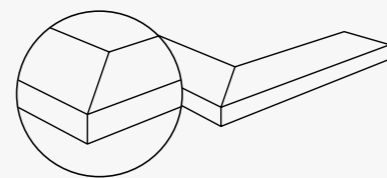

20 * 60 cm | 8 * 24" P70
 20 * 90 cm | 8 * 36" P75
 20 * 100 cm | 8 * 39" P80
 20 * 100 * 2 cm | 8 * 39" P86
 (PACK 2 units)

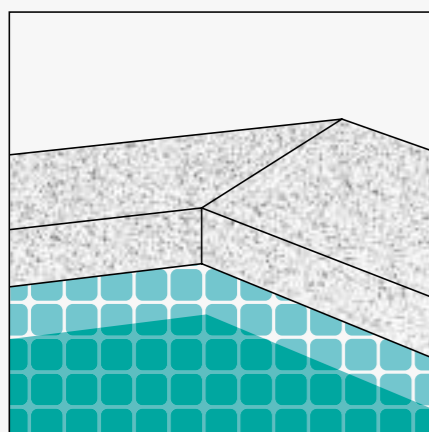

2 PELDAÑO VIERTEGUA ÁNGULO POOL COPING INTERNAL CORNER (ANG.PV.)

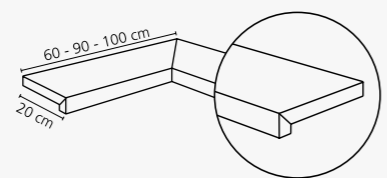

20 * 60 cm | 8 * 24" P70
 20 * 90 cm | 8 * 36" P75
 20 * 100 cm | 8 * 39" P80
 20 * 100 * 2 cm | 8 * 39" P86
 (PACK 2 units)

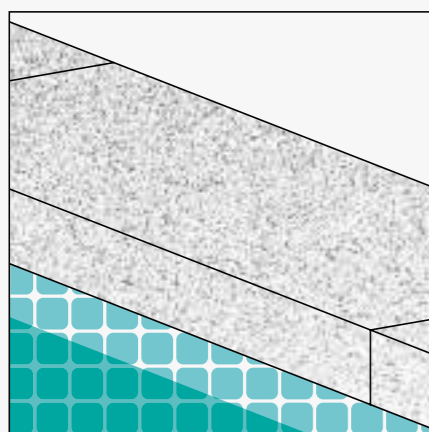

3 PELDAÑO VIERTEGUA POOL COPING (PV.)

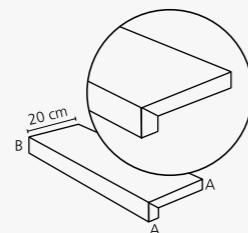

20 * 60 cm | 8 * 24" P70
 20 * 90 cm | 8 * 36" P75
 20 * 100 cm | 8 * 39" P80
 20 * 100 * 2 cm | 8 * 39" P86
 (PACK 2 units)
 A = 0,6 cm B = 1,8 cm
 A = 0,8 cm B = 2,4 cm
 A = 1 cm B = 3 cm

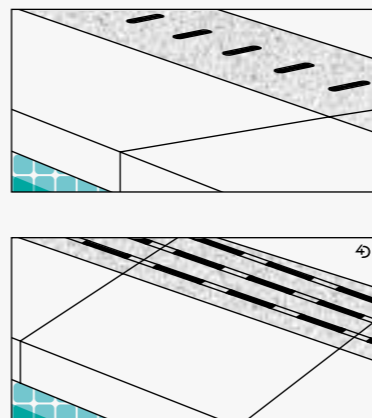

4 REJILLA DRAINAGE GRATE (REJ.)

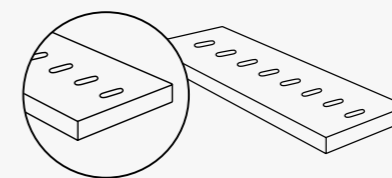

15 * 60 * 2 cm | 6 * 24" P54
 15 * 90 * 2 cm | 6 * 36" P76

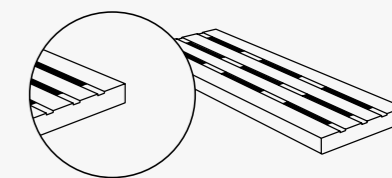

15 * 50 * 1,6 cm | 6 * 20" P87
 15 * 50 * 2 cm | 6 * 20" P54

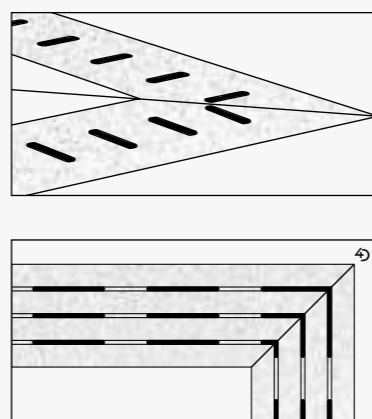

5 ÁNGULO REJILLA ANGLE CORNER DRAINAGE GRATE (ANG.REJ.)

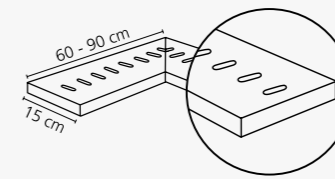

15 * 60 * 2 cm | 6 * 24" P75
 15 * 90 * 2 cm | 6 * 36" P57
 (PACK 2 units)

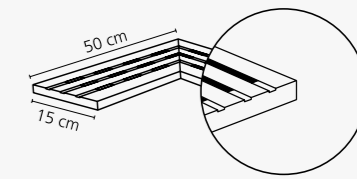

15 * 50 * 1,6 cm | 6 * 20" P74
 15 * 50 * 2 cm | 6 * 20" P86
 (PACK 2 units)

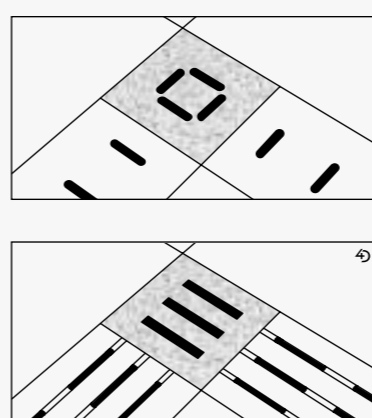

6 TACO REJILLA SQUARE CORNER DRAINAGE GRATE (T.REJ.)

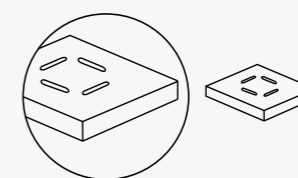

15 * 15 * 2 cm | 6 * 6" P85

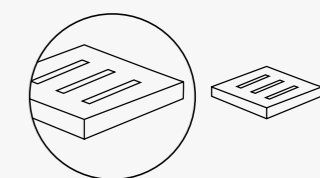

15 * 15 * 1,6 cm | 6 * 6" P66
 15 * 15 * 2 cm | 6 * 6" P71

EMBALAJE PLACA | SLAB PACKING

(Los pesos aquí reflejados pueden sufrir ligeras variaciones en función del lote de producción. Weights shown here may slightly vary depending on the production lot.)

1 PLACA SLAB			CAJÓN MADERA WOODEN CRATE			CONT./20' 25000 KG.			CONT./40' 25000 KG.		
cm	m ²	kg	Placas	m ²	kg	Cajones	m ²	kg	Cajones	m ²	kg
100 x 275 x 0,6	2,75	38,5	20	55	869	24	1320	20856	29	1595	25201
inch	ft ²	lb	Slabs	ft ²	lb	Crates	ft ²	lb	Crates	ft ²	lb
39 3/8 x 108 1/4 x 1/4	29,6	84,88	20	592	1916	24	14208,4	45980	29	17168,4	55558,7
1 PLACA SLAB			CABALLETE A-FRAME			CONT./20' 24000 KG.			CONT./40' 24000 KG.		
cm	m ²	kg	Placas	m ²	kg	Caballette	m ²	kg	Caballette	m ²	kg
100 x 275 x 0,6	2,75	38,5	50	137,5	2024	6	825	12144	11	1512,5	22264
inch	ft ²	lb	Slabs	ft ²	lb	A-frame	ft ²	lb	A-frame	ft ²	lb
39 3/8 x 108 1/4 x 1/4	29,6	84,88	50	1480	4343	6	8880	26058	11	16280	47773

CAJÓN DE MADERA WOODEN CRATE

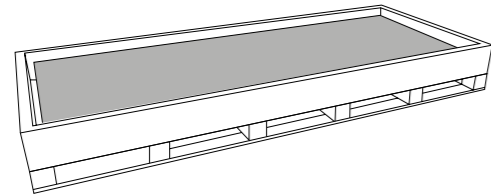

Tamaño aprox. cm.
291 x 112 x 33 cm

Approx. inch. sizes
114 9/16 x 44 1/8 x 12 3/16

CABALLETE A-FRAME

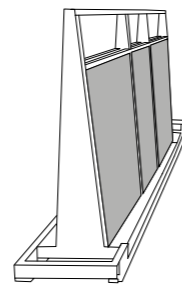

Tamaño aprox. cm.
290 x 75 x 152 cm

Approx. inch. sizes
114 1/8 x 29 1/2 x 59 7/8"



Accede al código QR y visualiza el manual técnico de colocación de gran formato.
Enter with the QR code and view the technical manual for laying slabs.

EMBALAJE REVESTIMIENTO | WALL PACKING

(Los pesos aquí reflejados pueden sufrir ligeras variaciones en función del lote de producción. Weights shown here may slightly vary depending on the production lot.)

FORMATO SIZES	CAJAS BOXES			PALLET			CONT./20' 21500 KG.	CONT./20' 24000 KG.	
cm	Piezas	m ²	kg	Cajas	m ²	kg	Tamaño aprox. cm	m ²	m ²
25 * 75 * 1,05	7	1,31	24,7	42	55,02	1061,2	80 * 120 * 90	1114,71	1210,44
32 * 90 * 1,05	4	1,15	20,9	56	64,4	1194,2	80 * 120 * 105	1159,20	1294,44
33 * 91 * 1,05	4	1,2	21,8	51	61,2	1135,6	80 * 120 * 106	1158,52	1293,16
33,3 * 100 * 0,75	6	2	24,92	24	48	640,08	105 * 118 * 48	1440	1440
33,3 * 100 * 0,86	5	1,67	22,45	24	40,08	580,8	105 * 118 * 48	1202,40	1202,40
inch	units	ft ²	lb	Boxes	ft ²	lb	Sizes Inch approx.	ft ²	ft ²
9 13/16 * 29 1/2 * 7/16	7	14,10	54,34	42	592,02	2334,64	31 1/2 * 47 1/4 * 35 7/16	11994,23	13024,33
12 5/8 * 35 7/16 * 7/16	4	12,37	45,98	56	692,94	2627,24	31 1/2 * 47 1/4 * 41 5/16	12472,99	13928,17
13 * 35 13/16 * 7/16	4	12,91	47,96	51	658,51	2498,32	31 1/2 * 47 1/4 * 41 3/4	12465,63	13914,36
13 1/8 * 39 3/8 * 5/16	6	21,52	54,82	24	516,48	1408,18	41 5/16 * 46 7/16 * 18 7/8	15494,40	15494,40
13 1/8 * 39 3/8 * 5/16	5	17,97	49,39	24	431,26	1277,76	41 5/16 * 46 7/16 * 18 7/8	12937,82	12937,82

EMBALAJE PAVIMENTO | FLOOR PACKING

(Los pesos aquí reflejados pueden sufrir ligeras variaciones en función del lote de producción. Weights shown here may slightly vary depending on the production lot.)

FORMATO SIZES	CAJAS BOXES			PALLET			CONT./20' 21500 KG.	CONT./20' 24000 KG.	
cm	Piezas	m ²	kg	Cajas	m ²	kg	Tamaño aprox. cm	m ²	m ²
100 x 100 x 2	1	1	49,2	24	24	1222,8	112 x 112 x 85	421,92	471,12
100 x 100 x 0,6	2	2	29,92	24	48	766,08	112 x 112 x 60	1346,88	1440,00
100 x 100 x 0,8	2	2	39,3	32	64	1305,6	112 x 112 x 100	1054,08	1176,32
100 x 180 x 0,6	2	3,6	52,92	24	86,4	1320,08	115 x 190 x 60	1407,46	1570,75
100 x 180 x 0,8	2	3,6	70,88	20	72	1467,52	115 x 190 x 60	1054,80	1177,20
15 x 90 x 1	7	0,95	21,69	48	45,6	1066,456	100 x 100 x 75	919,30	1026,00
19,5 x 121,5 x 1	4	0,95	22,16	40	38	911,72	95 x 128 x 55	896,04	1000,16
23 x 180 x 1,1	3	1,24	33,7	36	44,64	1263,2	84 x 184 x 65	758,88	758,88
24 x 151 x 1	3	1,09	24,26	48	52,32	1199,72	93 x 156 x 63	889,44	889,44
29 x 90 x 1	3	0,78	18,97	54	42,12	1049,38	95 x 105 x 75	863,04	963,28
30 x 60 x 1	6	1,08	24,29	48	51,84	1190,008	80 x 120 x 75	936,75	1045,61
33 x 33 x 0,9	10	1,09	22,21	52	56,68	1178,824	80 x 120 x 81	1033,84	1246,96
45 x 90 x 1	2	0,81	19,08	36	29,16	698,88	100 x 100 x 59	896,96	1003,10
50 x 100 x 0,8	3	1,5	28,19	24	36	718,776	80 x 120 x 66	1076,76	1188,00
50 x 100 x 2	1	0,5	24,7	48	24	1227,6	112 x 112 x 85	420,24	469,20
60 x 120 x 1	2	1,44	33,18	27	38,88	919,66	80 x 120 x 75	909,01	1014,77
60 x 60 x 1	3	1,08	24,30	36	38,88	898,672	80 x 120 x 75	930,01	1038,48
* 60 x 60 x 1	3	1,08	24,30	40	43,2	995,08	80 x 120 x 75	933,55	1041,98
75,5 x 151 x 1	1	1,14	26	44	50,16	1179	93 x 156 x 76	852,72	852,72
9,9 x 60 x 1	13	0,77	16,45	72	55,44	1196,4	100 x 100 x 94	996,29	1112,14
90 x 90 x 1	2	1,62	37,96	22	35,64	860,12	95 x 105 x 75	891	994,36
inch	units	ft ²	lb	Boxes	ft ²	lb	Sizes Inch approx.	ft ²	ft ²
39 3/8 x 39 3/8 x 13/16	1	10,76	108,24	24	258,24	2690,16	44 1/16 x 44 1/16 x 33 7/16	4539,86	5069,25
39 3/8 x 39 3/8 x 1/4	2	21,52	65,82	24	516,48	1685,38	44 1/16 x 44 1/16 x 23 5/8	14492,43	15494,40
39 3/8 x 39 3/8 x 5/16	2	21,52	86,46	32	688,64	2872,32	44 1/16 x 44 1/16 x 39 3/8	11341,90	12657,20
39 3/8 x 70 7/8 x 1/4	2	38,74	116,42	24	929,66	2904,18	45 1/4 x 74 13/16 x 23 5/8	15144,23	16901,29
39 3/8 x 70 7/8 x 5/16	2	38,74	155,94	20	774,72	3228,54	45 1/4 x 74 13/16 x 23 5/8	11349,65	12666,67
5 7/8 x 35 7/16 x 3/8	7	10,22	47,73	48	490,66	2346,20	39 3/8 x 39 3/8 x 29 1/2	9891,62	11039,76
7 11/16 x 47 13/16 x 3/8	4	10,22	48,77	40	408,88	2005,78	37 3/8 x 50 3/8 x 21 5/8	9641,39	10761,72
9 1/16 x 70 7/8 x 7/16	3	13,34	74,14	36	480,33	2779,04	33 1/16 x 72 7/16 x 25 9/16	8165,55	8165,55
9 7/16 x 59 7/16 x 3/8	3	11,73	53,38	48	562,96	2639,38	36 5/8 x 61 7/16 x 24 13/16	9570,37	9570,37
11 7/16 x 35 7/16 x 3/8	3	8,39	41,73	54	453,21	2308,64	37 3/8 x 41 5/16 x 29 1/2	9286,30	10364,94
11 13/16 x 23 5/8 x 3/8	6	11,62	53,45	48	557,80	2618,02	31 1/2 x 47 1/4 x 29 1/2	10079,42	11250,79
13 x 13 x 3/8	10	11,73	48,87	52	609,88	2593,41	31 1/2 x 47 1/4 x 31 7/8	11124,15	13417,29
17 11/16 x 35 7/16 x 3/8	2	8,72	41,98	36	313,76	1537,54	39 3/8 x 39 3/8 x 23 1/4	9651,31	10793,40
19 11/16 x 39 3/8 x 5/16	3	16,14	62,04	24	387,36	1581,31	31 1/2 x 47 1/4 x 26	11585,94	12782,88
19 11/16 x 39 3/8 x 3/4	1	5,38	54,34	48	258,24	2700,72	44 1/16 x 44 1/16 x 33 7/16	4521,78	5048,59
23 5/8 x 47 1/4 x 3/8	2	15,49	73,00	27	418,35	2023,25	31 1/2 x 47 1/4 x 29 1/2	9780,99	10918,90
23 5/8 x 23 5/8 x 3/8	3	11,62	53,46	36	418,35	1977,08	31 1/2 x 47 1/4 x 29 1/2	10006,90	11174,10
23 5/8 x 23 5/8 x 3/8	3	11,62	53,46	40	464,83	2189,18	31 1/2 x 47 1/4 x 29 1/2	10045,02	11211,75
29 3/4 x 59 7/16 x 7/16	1	12,27	57,20	44	539,72	2593,80	36 5/8 x 61 7/16 x 29 15/16	9175,27	9175,27
3 7/8 x 23 5/8 x 3/8	13	8,29	36,19	72	596,53	2632,08	39 3/8 x 39 3/8 x 37	10720,08	11966,63
35 7/16 x 35 7/16 x 3/8	2	17,43	83,51	22	383,49	1892,26	37 3/8 x 41 5/16 x 29 1/2	9587,16	10699,27

* colecciones | collections: GHENT, LUCCA, MANHATTAN, DOWNTOWN

FS VINTAGE

FS ALORA	268	FS PORTO	317
FS ARLES	269	FS RAKU	319
FS ARTISAN	271	FS ROAD	321
FS AURORA	272	FS ROCKSTAR	325
FS BLUME	273	FS ROOTS	327
FS BRETAGNE	274	FS SAJA	328
FS CHESTER	275	FS SEA	329
FS CLAY	277	FS SEATTLE	330
FS DAMERO	281	FS SENA	331
FS ETNA	283	FS STAR	333
FS FAENZA	285	FS STAR LT	337
FS FIELD	287	FS TEMPLE	341
FS FOREST	291	FS TRADITION	343
FS HERITAGE	295	FS VENDOME	344
FS IRON	297	FS VENECIA	345
FS IVY	298	FS WABI SABI	347
FS JAIPUR	299	FS WILD	349
FS LOFT	303	FS YARD	351
FS MARAIS	305		
FS MARRAKECH	306	FS TILES	354
FS MELVIN	307	_Índice Alfabético _ Embalaje _ Características Técnicas	
FS MIRABEL	308	_Alphabetic tiles _Packing _ Technical Characteristics	
FS MUD	309		
FS NORWICH	312		
FS OFELIA	313		
FS ORIGINAL	315		



tiles



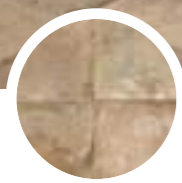

FS Alora

FS Alora

SINGLE FIRED FLOOR TILES



FS Arles Green LT FS Roots-0



FS Arles Brown LT

FS Arles

SINGLE FIRED FLOOR TILES

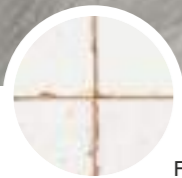

FS Artisan-B



FS Artisan Decor-A
Mumble-G_15*90



FS Oldker



FS Aurora
Black

FS Aurora

SINGLE FIRED FLOOR TILES



FS Blume Black
FS Etna Black



FS Blume
White

FS Blume

SINGLE FIRED FLOOR TILES

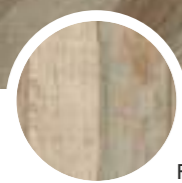

FS Bretagne

FS Bretagne

SINGLE FIRED FLOOR TILES



FS Comillas

FS Chester

SINGLE FIRED FLOOR TILES



FS Mud White



FS Blossom



FS Checker Silver



FS Checker Sand



FS Seal

FS Clay

SINGLE FIRED FLOOR TILES

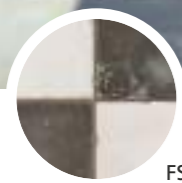

FS Damero-N

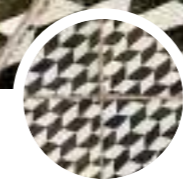

FS Espiga-N

FS Damero

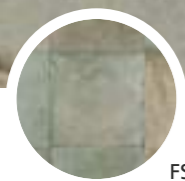

FS Etna Sage



FS Etna Black

FS Etna



FS Faenza-A C. FS Faenza-A T. FS Faenza-A FS Manises-B C. FS Manises-B T. FS Manises-B



FS Faenza-A C. FS Faenza-A T. FS Faenza-A FS Manises-B C. FS Manises-B T. FS Manises-B



FS Manises-B



FS Faenza Black

FS Faenza

SINGLE FIRED FLOOR TILES



FS Field Brown
FS Rock

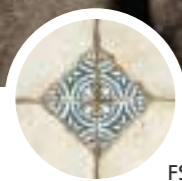

FS Field Blue

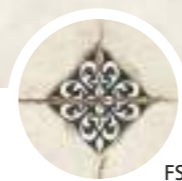

FS Field Black

FS Field



FS Forest Natural



FS Forest White



FS Forest Black

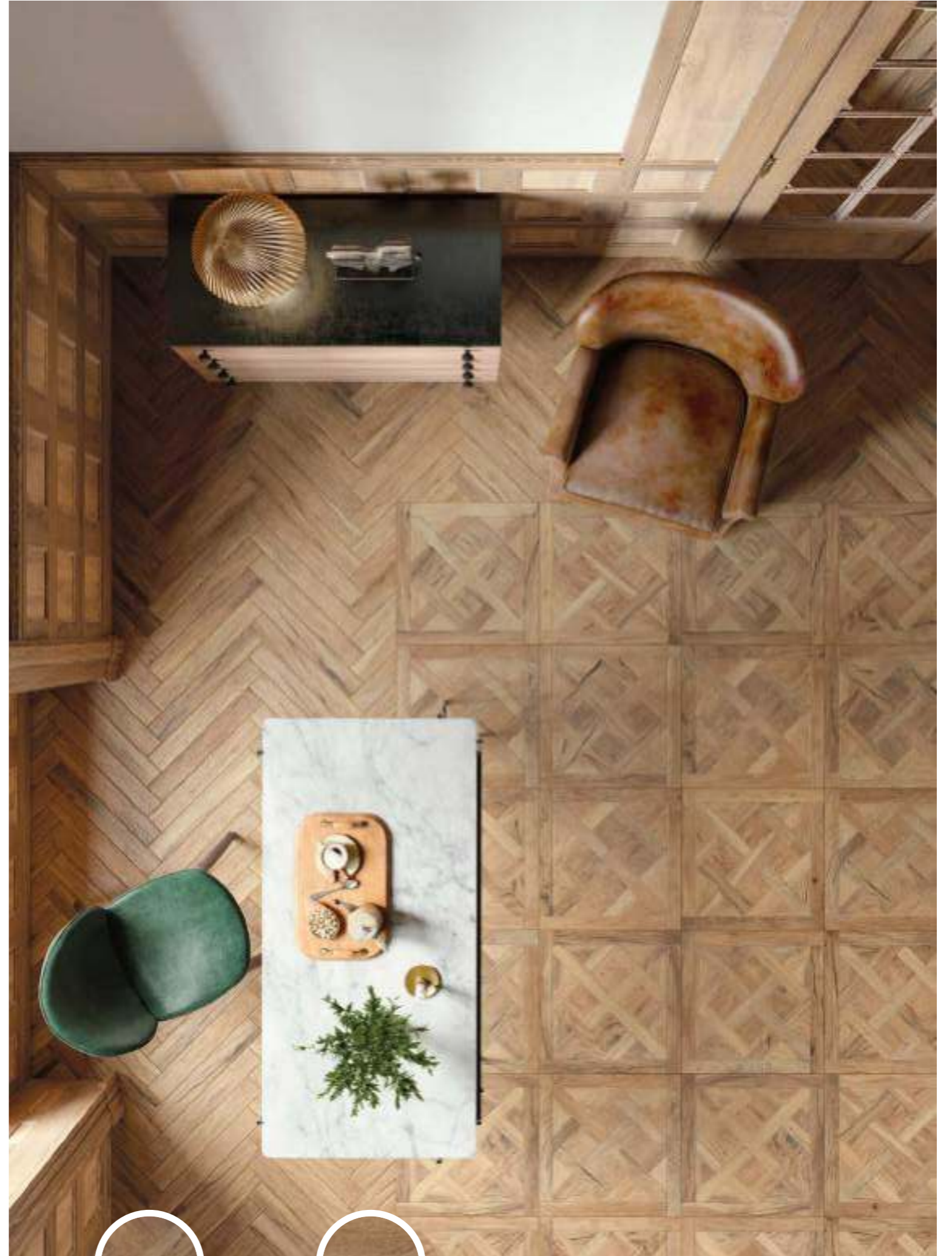

FS Forest Natural



FS Forest Plank

FS Forest

SINGLE FIRED FLOOR TILES



FS Heritage Square



FS Heritage White



FS Heritage Ornate



FS Iron White
FS Forest Natural

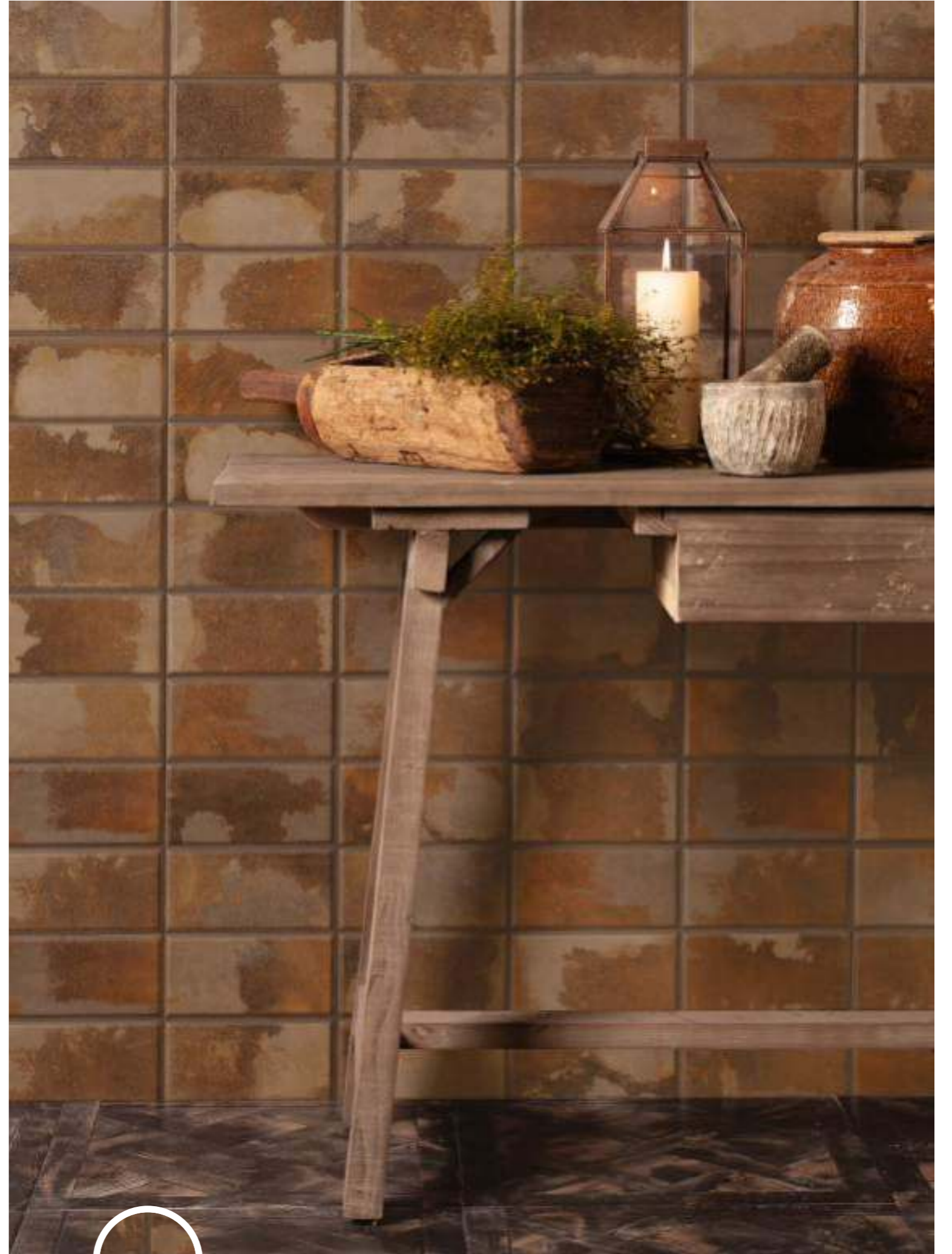

FS Iron
Oxide

FS Iron

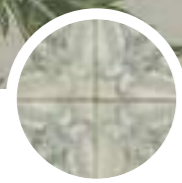

FS Ivy Sage

FS Ivy

SINGLE FIRED FLOOR TILES



FS Jaipur
Black LT



Fs Loft
White

FS Jaipur

SINGLE FIRED FLOOR TILES



FS Jaipur
White LT



FS Loft
White



FS Forest
Natural



FS Loft Black Jaipur White LT



FS Loft Clay



FS Marais

FS Loft

WHITE BODY WALL TILES

FS Marais

PORCELAIN TILES



FS Marrakech
Blue



FS Melvin
White



FS Vintage

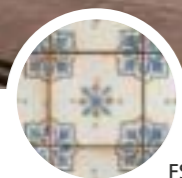

FS Alora
FS Mirambel-A

FS Mirambel
SINGLE FIRED FLOOR TILES



FS Mud Sand
FS Checker Sand

FS Mud
WHITE BODY WALL TILES



FS Seal

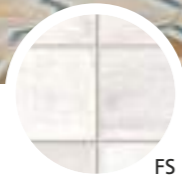

FS Mud White



FS Norwich

FS Norwich

PORCELAIN TILES



FS Ofelia

FS Ofelia

PORCELAIN TILES





FS Nijar
FS 0



FS Porto Iria



FS Tradition White Brick LT FS Porto Fatima



FS Porto Amaral



FS Tradition White Brick LT

FS Porto

SINGLE FIRED FLOOR TILES

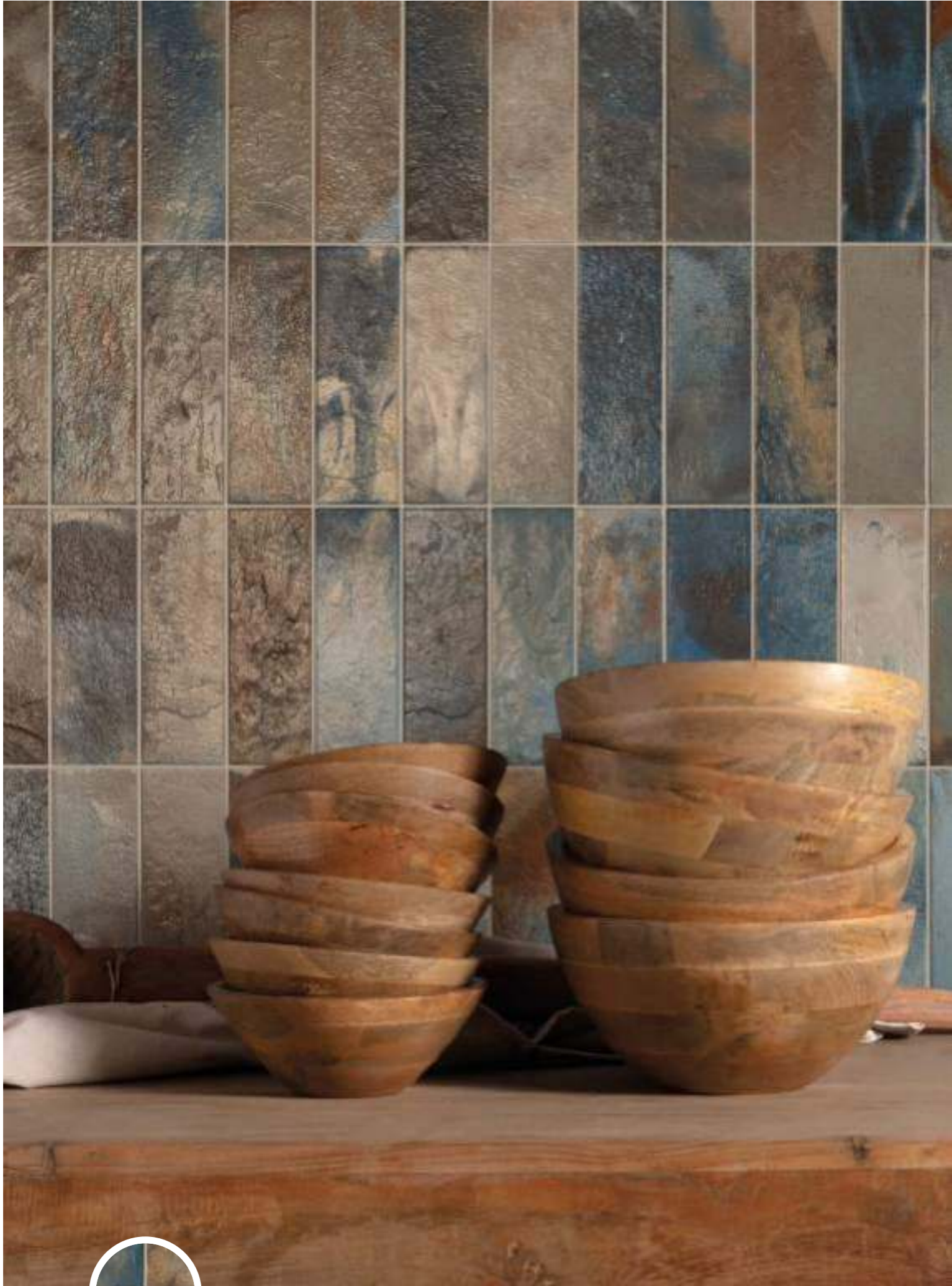

FS Raku colors



FS Raku Black
FS Star-N

FS Raku



FS Road
Moon



FS Road
Moon



FS Road
Mars

FS Road



FS Rockstar



FS Raku Cream FS Roots 3



FS Raku Blue FS Roots 1 FS Roots 3 FS Roots 4



FS Roots 1



FS Raku Blue

FS Roots

SINGLE FIRED FLOOR TILES



FS Saja N

FS Saja

SINGLE FIRED FLOOR TILES



FS Sea
Blue LT



FS Sea
White LT

FS Sea

SINGLE FIRED FLOOR TILES



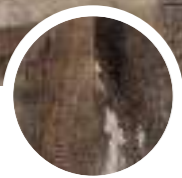

FS Seattle

FS Seattle

PORCELAIN TILES



FS Sena Blue
FS Rue

FS Sena

PORCELAIN TILES



FS Star N



FS Star
Oxide

FS Star

SINGLE FIRED FLOOR TILES



FS Star Sky



FS Star Night



FS Star
White

FS Star

SINGLE FIRED FLOOR TILES



FS Star LT
Blue



FS Star LT
White

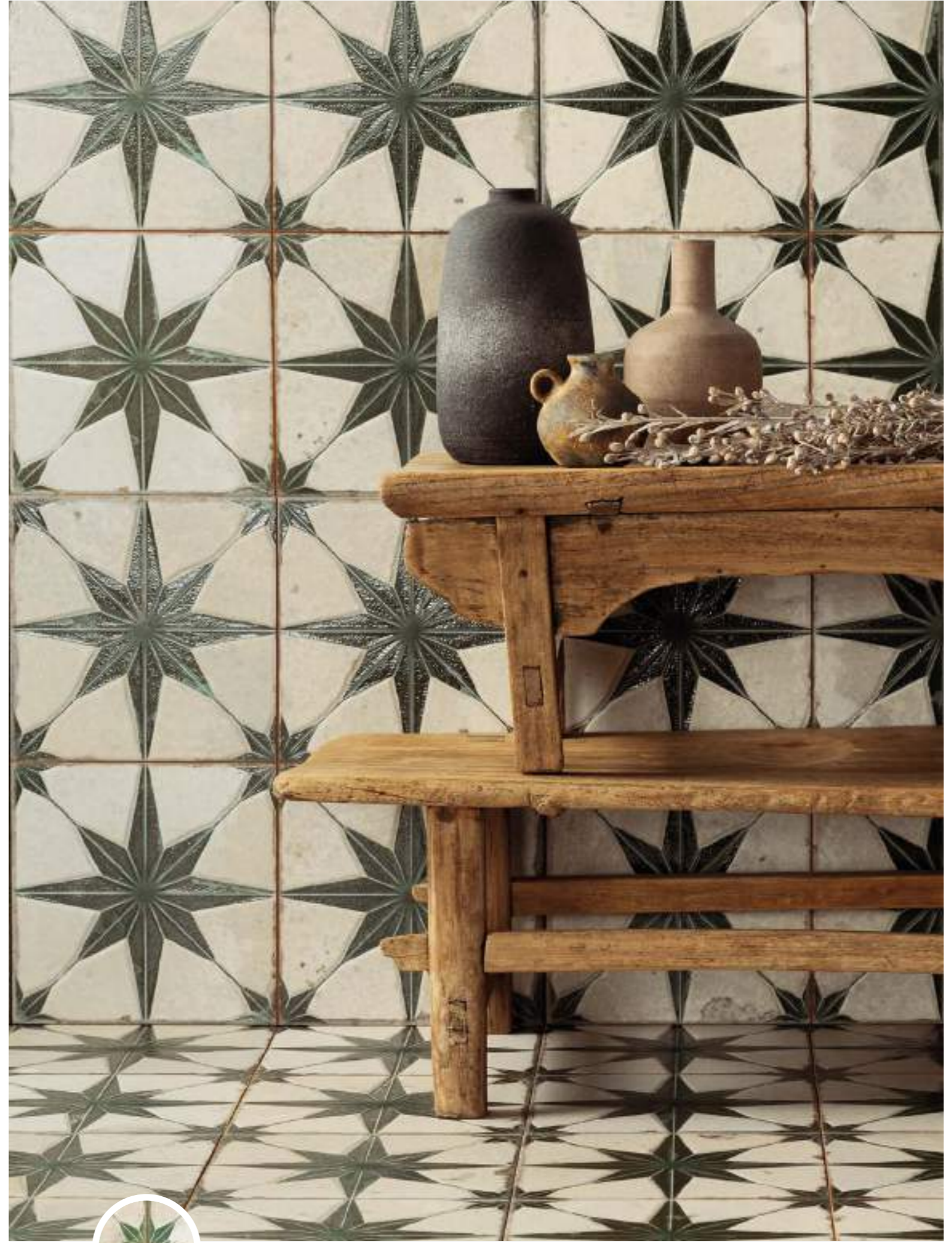

FS Star LT
Sage

FS Star LT



FS Vintage



FS Star LT
Black

FS Star LT

SINGLE FIRED FLOOR TILES

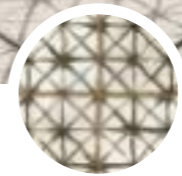

FS Temple
Black

FS Temple

SINGLE FIRED FLOOR TILES



FS Vintage

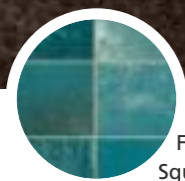

FS Tradition
Square Green



FS Tradition Square Blue FS Heritage Square



FS Tradition Square White



FS Vintage

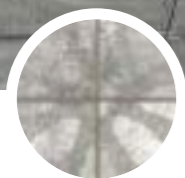

FS Vendome
FS Rue

FS Vendome

PORCELAIN TILES



FS Venecia/46



FS Ofelia

FS Venecia

PORCELAIN TILES

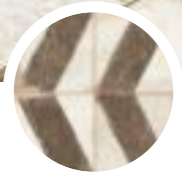

FS Wabi Arrow

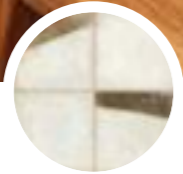

FS Sabi FS Roots 0



FS Vintage



FS Wild

FS Wild

PORCELAIN TILES



FS Aurora
Black



FS Yard Black

A

FS Alora collection

SINGLE FIRED FLOOR TILES

45 * 45 * 0,95 cm | 18 * 18"



FS ALORA

FS Arles collection

SINGLE FIRED FLOOR TILES

33 * 33 * 0,95 cm | 13 * 13"

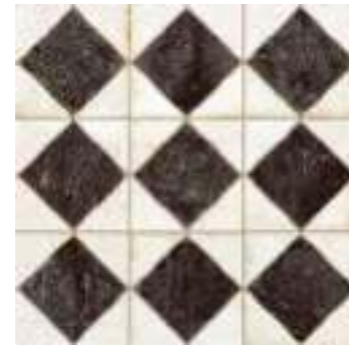

FS ARLES Black LT



FS ARLES Brown LT



FS ARLES Blue LT



FS ARLES Green LT

FS Artisan collection

SINGLE FIRED FLOOR TILES

33 * 33 * 0,95 cm | 13 * 13"

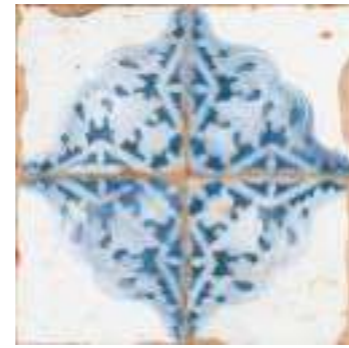

FS ARTISAN DECOR -A



FS OLDKER



FS ARTISAN DAMERO -A



FS ARTISAN-B

FS Aurora collection

SINGLE FIRED FLOOR TILES

45 * 45 * 0,95 cm | 18 * 18"



FS AURORA White



FS AURORA Sage



FS AURORA Black



FS AURORA Blue

B

FS Blume collection

SINGLE FIRED FLOOR TILES

45 * 45 * 0,95 cm | 18 * 18"



FS BLUME White



FS BLUME Black



FS BLUME Blue

B

FS Blume collection

SINGLE FIRED FLOOR TILE

45 * 45 * 0,95 cm | 18 * 18"



FS BLUME Sage

FS Bretagne collection

SINGLE FIRED FLOOR TILE

45 * 45 * 0,95 cm | 18 * 18"



FS BRETAGNE

C

FS Chester collection

SINGLE FIRED FLOOR TILE

45 * 45 * 0,95 cm | 18 * 18"
33 * 33 * 0,95 cm | 13 * 13"



FS CHESTER

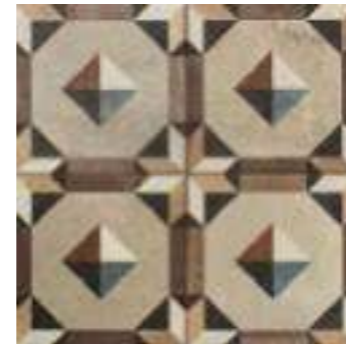

FS COMILLAS

FS Clay collection

SINGLE FIRED FLOOR TILE

45 * 45 * 0,95 cm | 18 * 18"



FS BLOSSOM



FS SEAL



FS CHECKER sand

D

FS Damero collection

SINGLE FIRED FLOOR TILE

45 * 45 * 0,95 cm | 18 * 18"



FS DAMERO -N



FS ESPIGA



FS ROMBOS -N

E

FS Etna collection

SINGLE FIRED FLOOR TILE

33 * 33 * 0,95 cm | 13 * 13"



FS ETNA white



FS ETNA black



FS ETNA sage



FS ETNA blue

F

FS Faenza collection

SINGLE FIRED FLOOR TILE

33 * 33 * 0,95 cm | 13 * 13"



FS FAENZA -A



FS FAENZA -B



FS MANISES

FS Field collection

PORCELAIN TILES

45,2 * 45,2 * 0,87 cm | 18 * 18"



FS FIELD black LT



FS FIELD blue LT



FS FIELD brown LT

FS Forest collection

SINGLE FIRED FLOOR TILE

45 * 45 * 0,95 cm | 18 * 18"
7,3 * 45 * 1,05 cm | 2,9 * 18"

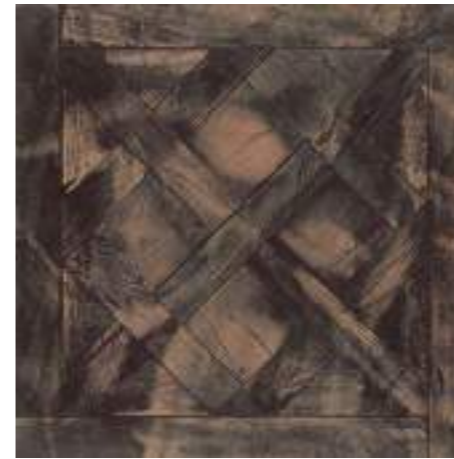

FS FOREST black



FS FOREST NATURAL



FS FOREST white

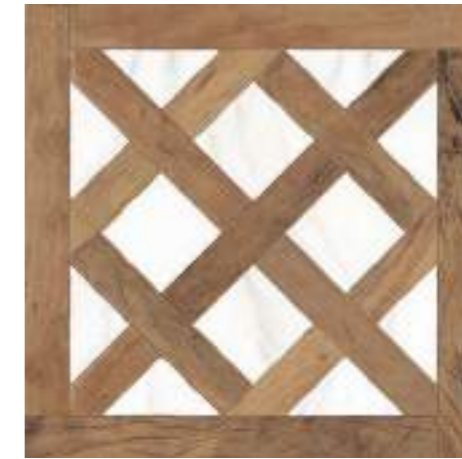

FS FOREST natural mix



FS FOREST plank

H

FS Heritage collection

SINGLE FIRED FLOOR TILE

45 * 45 * 0,95 cm | 18 * 18"

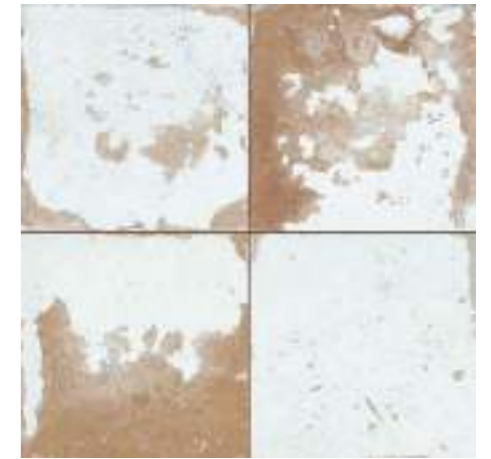

FS HERITAGE white LT



FS HERITAGE ornate LT



FS HERITAGE leaves LT

H

FS Heritage collection

SINGLE FIRED FLOOR TILE

45 * 45 * 0,95 cm | 18 * 18"



FS HERITAGE square LT

I

FS Iron collection

WHITE BODY WALL TILE

20 * 40 * 1,03 cm | 8 * 16"

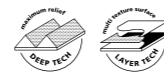

FS IRON white LT



FS IRON oxide LT

FS Ivy collection

SINGLE FIRED FLOOR TILE

45 * 45 * 0,95 cm | 18 * 18"



FS IVY black



FS IVY blue



FS IVY sage

J

FS Jaipur collection

SINGLE FIRED FLOOR TILE

45 * 45 * 0,95 cm | 18 * 18"

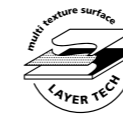

FS JAIPUR white LT



FS JAIPUR black LT

L

FS Loft collection

WHITE BODY WALL TILE

20 * 40 * 1,03 cm



FS LOFT white



FS LOFT clay



FS LOFT black

M

FS Marais collection

PORCELAIN TILE

45,2 * 45,2 * 0,87 cm | 18 * 18"



FS MARAIS

M

FS Marrakech collection

SINGLE FIRED FLOOR TILE

45 * 45 * 0,95 cm | 18 * 18"



FS MARRAKECH grey

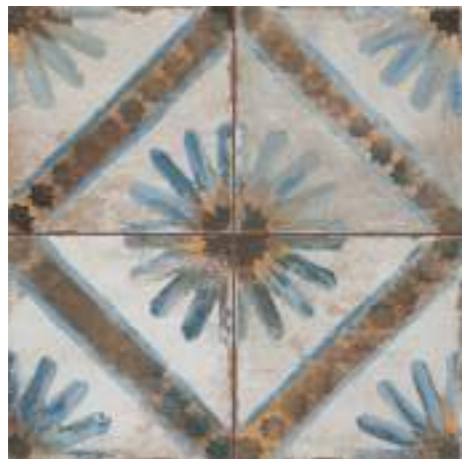

FS MARRAKECH blue

FS Melvin collection

PORCELAIN TILE

7,4 * 67,5 * 1,05 cm | 3 * 27"



FS MELVIN white



FS MELVIN color

FS Mirambel collection

SINGLE FIRED FLOOR TILE

33 * 33 * 0,95 cm | 13 * 13"



FS MIRAMBEL B



FS MIRAMBEL M



FS MIRAMBEL A

FS Mud collection

WHITE BODY WALL TILE

20 * 40 * 1,03 cm | 8 * 16"



FS MUD white



FS MUD silver



FS MUD sand



FS MUD cocoa

N

FS Norwich collection

PORCELAIN TILE

33 * 33 * 0,95 cm | 13 * 13"



FS NORWICH

O

FS Ofelia collection

PORCELAIN TILE

45,2 * 45,2 * 0,87 cm | 18 * 18"

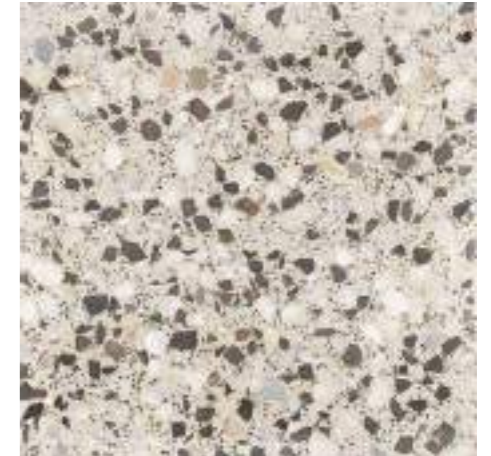

FS OFELIA

O

FS Original collection

SINGLE FIRED FLOOR TILE

45 * 45 * 0,95 cm | 18 * 18"



FS 0



FS 3



FS PORTO AMARAL



FS 1



FS 4



FS PORTO FATIMA



FS 2



FS NIJAR



FS PORTO FLAVIA

P

FS Porto collection

SINGLE FIRED FLOOR TILE

45 * 45 * 0,95 cm | 18 * 18"

R

FS Raku collection

WHITE BODY WALL TILE

20 * 40 * 1,03 cm | 8 * 16"



FS RAKU white

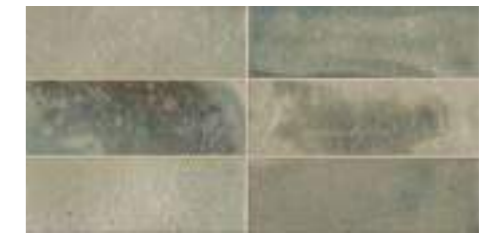

FS RAKU sage



FS RAKU black



FS RAKU color



FS RAKU silver



FS RAKU cream



FS RAKU blue

R

FS Road collection

PORCELAIN TILE

90 * 90 * 1 cm | 36 * 36"



FS ROAD mars AS



FS ROAD moon AS

FS Rockstar collection

PORCELAIN TILE

45,2 * 45,2 * 0,87 cm | 18 * 18"



FS ROCKSTAR -N AS



FS ROCK AS

FS Roots collection

SINGLE FIRED FLOOR TILE

45 * 45 * 0,95 cm | 18 * 18"



FS ROOTS 0



FS ROOTS 1



FS ROOTS 2



FS ROOTS 4



FS ROOTS 3

S

FS Saja collection

SINGLE FIRED FLOOR TILE

33 * 33 * 0,95 cm | 13 * 13"



FS SAJA N



FS SAJA B

FS Sea collection

SINGLE FIRED FLOOR TILE

33 * 33 * 0,95 cm | 13 * 13"



FS SEA white LT



FS SEA blue LT

S

FS Seattle collection

PORCELAIN TILE

30 * 30 * 0,8 cm | 12 * 12"



FS SEATTLE

FS Sena collection

PORCELAIN TILE

45,2 * 45,2 * 0,87 cm | 18 * 18"



FS SENA

FS Star collection

SINGLE FIRED FLOOR TILE

45 * 45 * 0,95 cm | 18 * 18"



FS STAR ARA black



FS STAR sage



FS STAR sky



FS STAR LT white



FS STAR white



FS STAR blue



FS STAR night



FS STAR LT black



FS STAR N



FS STAR oxide



FS STAR LT sage

FS Star LT collection

SINGLE FIRED FLOOR TILE

45 * 45 * 0,95 cm | 18 * 18"



S

FS Star LT collection

SINGLE FIRED FLOOR TILE

45 * 45 * 0,95 cm | 18 * 18"



FS STAR LT blue

T

FS Temple collection

SINGLE FIRED FLOOR TILE

45 * 45 * 0,95 cm | 18 * 18"

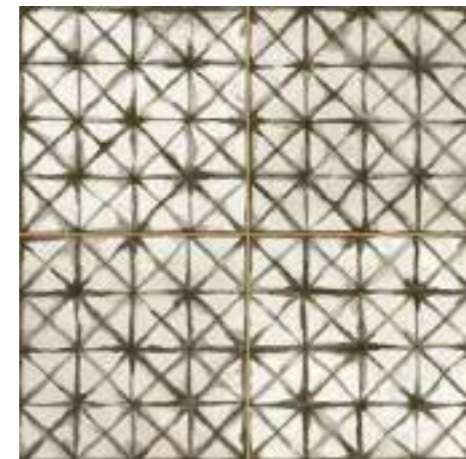

FS TEMPLE black

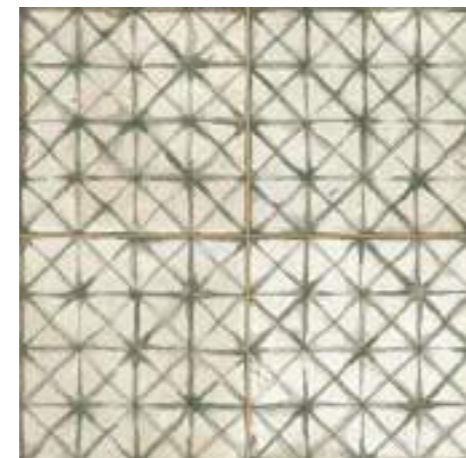

FS TEMPLE sage

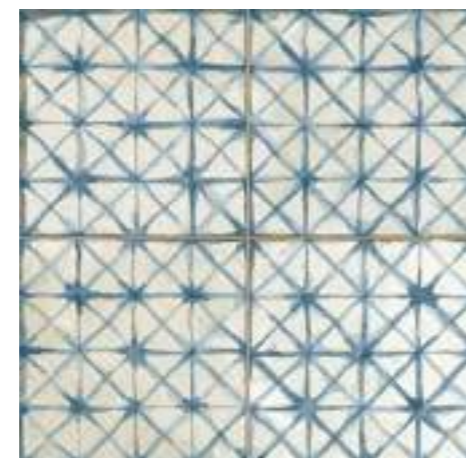

FS TEMPLE blue

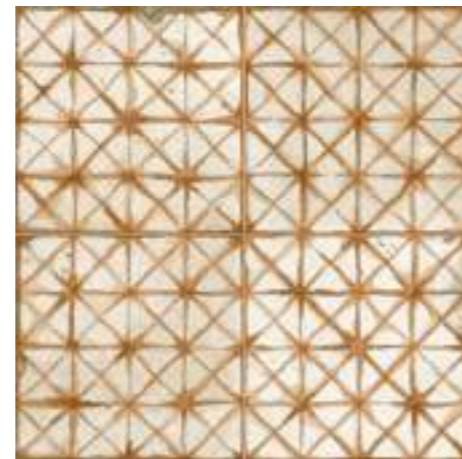

FS TEMPLE oxide

FS Tradition collection

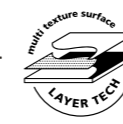

WHITE BODY WALL TILE

20 * 40 * 1,03 cm | 8 * 16"



FS TRADITION
BRICK white LT



FS TRADITION
SQUARE white LT



FS TRADITION
BRICK silver LT



FS TRADITION
SQUARE silver LT



FS TRADITION
BRICK green LT



FS TRADITION
SQUARE green LT



FS TRADITION
BRICK blue LT



FS TRADITION
SQUARE blue LT

V

FS Vendome collection

PORCELAIN TILE

45,2 * 45,2 * 0,87 cm | 18 * 18"



FS VENDOME



FS RUE

V

FS Venecia collection

PORCELAIN TILE

45,2 * 45,2 * 0,87 cm | 18 * 18
60 * 60 * 1 cm | 24 * 24"



FS VENECIA/46



FS VENECIA

FS Vintage

W

FS Wabi Sabi collection

SINGLE FIRED FLOOR TILES

45 * 45 * 0,95 cm | 18 * 18"
33 * 33 * 0,95 cm | 13 * 13"



FS WABI



FS WABIARROW



FS SABI

FS Wild collection

PORCELAIN TILE

19,5 * 121,5 * 1 cm



FS WILD AS

Y

FS Yard collection

SINGLE FIRED FLOOR TILES

45 * 45 * 0,95 cm | 18 * 18"



FS YARD black



FS YARD blue



FS YARD sage

EMBALAJE | PACKING

(Los pesos aquí reflejados pueden sufrir ligeras variaciones en función del lote de producción.
Weights shown here may slightly vary depending on the production lot.)

TIPO PASTA	FORMATO	CAJAS			PALLET				CONT./20'	CONT./20'
		Piezas	m ²	kg	Cajas	m ²	kg	Tamaño cm aprox.	m ²	m ²
	cm									
Porcelánico	60 * 60 * 1	3	1,08	24,302	40	43,2	995,08	80 * 120 * 75	933,55	1041,98
Porcelánico	45,2 * 45,2 * 0,87	5	1,02	19,62	66	67,32	1318,92	80 * 120 * 105	1097,00	1225,00
Gres	45 * 45 * 0,95	5	1	21	66	66	1410	80 * 120 * 105	1006,00	1123,00
Porcelánico	33 * 33 * 0,95	10	1,09	21,712	48	52,32	1065,976	80 * 120 * 81	1055,29	1151,04
Gres	33 * 33 * 0,95	10	1,09	21,392	48	52,32	1050,616	80 * 120 * 81	1070,47	1151,04
Porcelánico	30 * 30 * 0,8	12	1,09	20,53	48	52,32	1009,24	80 * 120 * 75	1114,42	1244,17
Pasta blanca - revestimiento	20 * 40 * 1,03	12	0,96	16,293	56	53,76	936,208	80 * 120 * 95	1182,72	1182,72
Porcelánico	7,4 * 67,5 * 1,05	15	0,75	17,135	63	47,25	1103,305	80 * 120 * 83	920,76	1027,82
Gres	7,3 * 45 * 1,05	25	0,82	20,95	48	39,36	1029,4	80 * 120 * 78	822,23	917,48
BODY TILE	SIZES	BOXES			PALLET				CONT./20'	CONT./20'
	inch	Units	ft2	lb	Boxes	ft2	lb	Sizes inch approx.	ft2	ft2
Porcelain	23 5/8 * 23 5/8 * 3/8	3	11,62	53,46	40	464,83	2189,18	31 1/2 * 47 1/4 * 29 1/2	10045,02	11211,75
Porcelain	17 13/16 * 17 13/16 * 3/8	5	10,98	43,16	66	724,36	2901,62	31 1/2 * 47 1/4 * 41 5/16	11803,72	13181,00
Single Fired	17 11/16 * 17 11/16 * 7/16	5	10,76	46,20	66	710,16	3102,00	31 1/2 * 47 1/4 * 41 5/16	10824,56	12083,48
Porcelain	13 * 13 * 3/8	10	11,73	47,77	48	562,96	2345,15	31 1/2 * 47 1/4 * 31 7/8	11354,97	12385,19
Single Fired	13 * 13 * 3/8	10	11,73	47,06	48	562,96	2311,36	31 1/2 * 47 1/4 * 31 7/8	11518,23	12385,19
Porcelain	11 13/16 * 11 13/16 * 5/16	12	11,73	45,17	48	562,96	2220,33	31 1/2 * 47 1/4 * 29 1/2	11991,12	13387,26
White Body wall tiles	7 7/8 * 15 3/4 * 3/8	12	10,33	35,84	56	578,46	2059,66	31 1/2 * 47 1/4 * 37 3/8	12726,07	12726,07
Porcelain	2 15/16 * 26 9/16 * 7/16	15	8,07	37,70	63	508,41	2427,27	31 1/2 * 47 1/4 * 32 11/16	9910,97	11063,36
Single Fired	2 15/16 * 26 9/16 * 7/16	25	8,82	46,09	48	423,51	2264,68	31 1/2 * 47 1/4 * 30 11/16	8847,20	9872,10

FS Vintage

Modelo Model	Artículo Article	Referencia Reference	Formato Size	Espesor Thickness	Tarifa Price List	Gráficas Patterns	Tipo de Pasta Tile Body	ISO 10545-7 (PEI)	DIN 51130 (R)	DIN 51087 (A+B+C)	UNE 41 901 EX (CLASS)	ANSI A 131,1 (DCOF)	BS 7976-2 (WET)	Color de junta Color Join MAPEI
	C. FS FAENZA-A	13714	11*33	9,5	P-12	9	Gres Single fired	-	-	-	-	-	-	110 Manhattan
	C. FS FAENZA-N	13715	11*33	9,5	P-12	9	Gres Single fired	-	-	-	-	-	-	110 Manhattan
	C. FS MANISES-B	13716	11*33	9,5	P-12	9	Gres Single fired	-	-	-	-	-	-	110 Manhattan
	COR.FS MIRAMBEL-A	27093	5*11	10	P-23	-	Pasta Blanca White Body	-	-	-	-	-	-	110 Manhattan
	COR.FS MIRAMBEL-M	27094	5*11	10	P-23	-	Pasta Blanca White Body	-	-	-	-	-	-	110 Manhattan
	FS 0	13305	45*45	10,5	BN-14	13	Gres Single fired	4	R-9	-	C1	>0,42	+36	110 Manhattan
	FS 1	12500	45*45	10,5	BN-14	10	Gres Single fired	4	R-9	-	C1	>0,42	+36	110 Manhattan
	FS 2	12501	45*45	10,5	BN-14	8	Gres Single fired	4	R-9	-	C1	>0,42	+36	110 Manhattan
	FS 3	12519	45*45	10,5	BN-14	5	Gres Single fired	4	R-9	-	C1	>0,42	+36	110 Manhattan
	FS 4	12541	45*45	10,5	BN-14	4	Gres Single fired	4	R-9	-	C1	>0,42	+36	110 Manhattan
	FS ALORA	19277	45*45	10,5	BN-14	17	Gres Single fired	4	R-9	-	C1	>0,42	+36	113 Cement Grey
	FS ARLES BLACK LT	31651	33*33	9,5	BN-17	5	Gres Single fired	3	-	-	-	-	-	110 Manhattan
	FS ARLES BLUE LT	31649	33*33	9,5	BN-17	5	Gres Single fired	3	-	-	-	-	-	110 Manhattan
	FS ARLES BROWN LT	31650	33*33	9,5	BN-17	5	Gres Single fired	3	-	-	-	-	-	110 Manhattan
	FS ARLES GREEN LT	31652	33*33	9,5	BN-17	5	Gres Single fired	3	-	-	-	-	-	110 Manhattan
	FS ARTISAN DAMERO-A	18244	33*33	9,5	BN-14	5	Gres Single fired	4	R-9	-	C1	>0,42	+36	110 Manhattan

Modelo Model	Artículo Article	Referencia Reference	Formato Size	Espesor Thickness	Tarifa Price List	Gráficas Patterns	Tipo de Pasta Tile Body	ISO 10545-7 (PEI)	DIN 51130 (R)	DIN 51097 (A+B+C)	UNE 41 901 EX (CLASS)	ANSI A 131,1 (COF)	BS 7976-2 (WET)	Color de junta Color Join MAPEI
	FS ARTISAN DECOR-A	18151	33*33	9,5	BN-14	5	Gres Single fired	4	R-9	-	C1	>0,42	+36	110 Manhattan
	FS ARTISAN-B	18150	33*33	9,5	BN-14	6	Gres Single fired	5	R-9	-	C1	>0,42	+36	110 Manhattan
	FS AURORA BLACK	27277	45*45	10,5	BN-14	10	Gres Single fired	4	R-9	-	C1	> 0,42	+36	110 Manhattan
	FS AURORA BLUE	27279	45*45	10,5	BN-14	10	Gres Single fired	4	R-9	-	C1	> 0,42	+36	110 Manhattan
	FS AURORA SAGE	27278	45*45	10,5	BN-14	10	Gres Single fired	4	R-9	-	C1	> 0,42	+36	110 Manhattan
	FS AURORA WHITE	27276	45*45	10,5	BN-14	10	Gres Single fired	4	R-9	-	C1	> 0,42	+36	110 Manhattan
	FS BLOSSOM	30065	45*45	10,5	BN-14	10	Gres Single fired	4	R-9	-	C1	>0,42	+36	110 Manhattan
	FS BLUME BLACK	27228	45*45	10,5	BN-14	10	Gres Single fired	4	R-9	-	C1	> 0,42	-	110 Manhattan
	FS BLUME BLUE	27226	45*45	10,5	BN-14	10	Gres Single fired	4	R-9	-	C1	> 0,42	-	110 Manhattan
	FS BLUME SAGE	27227	45*45	10,5	BN-14	10	Gres Single fired	4	R-9	-	C1	> 0,42	-	110 Manhattan
	FS BLUME WHITE	27229	45*45	10,5	BN-14	10	Gres Single fired	4	R-9	-	C1	> 0,42	-	110 Manhattan
	FS BRETAGNE	16446	45*45	10,5	BN-14	16	Gres Single fired	4	R-9	-	C1	-	-	113 Cement Grey
	FS CHECKER SAND	30067	45*45	10,5	BN-14	10	Gres Single fired	3	R-9	-	C1	>0,42	+36	110 Manhattan
	FS CHECKER SILVER	30068	45*45	10,5	BN-14	10	Gres Single fired	3	R-9	-	C1	>0,42	+36	110 Manhattan
	FS CHESTER	21009	45*45	10,5	BN-14	6	Gres Single fired	4	R-9	-	C1	-	-	113 Cement Grey
	FS COMILLAS	20933	33*33	9,5	BN-14	8	Gres Single fired	4	R-10	A+B	C2	>0,42	+36	113 Cement Grey
	FS DAMERO-N	15077	45*45	10,5	BN-14	13	Gres Single fired	4	R-9	-	C1	>0,42	+36	110 Manhattan
	FS ESPIGA	15816	45*45	10,5	BN-14	3	Gres Single fired	4	R-9	-	C1	>0,42	+36	110 Manhattan



















Modelo Model	Artículo Article	Referencia Reference	Formato Size	Espesor Thickness	Tarifa Price List	Gráficas Patterns	Tipo de Pasta Tile Body	ISO 10545-7 (PEI)	DIN 51130 (R)	DIN 51097 (A+B+C)	UNE 41 901 EX (CLASS)	ANSI A 131,1 (COF)	BS 7976-2 (WET)	Color de junta Color Join MAPEI
	FS ETNA BLACK	27230	33*33	9,5	BN-14	11	Gres Single fired	4	R-9	-	C1	> 0,42	-	113 Cement Grey
	FS ETNA BLUE	27232	33*33	9,5	BN-14	11	Gres Single fired	4	R-9	-	C1	> 0,42	-	113 Cement Grey
	FS ETNA SAGE	27233	33*33	9,5	BN-14	11	Gres Single fired	4	R-9	-	C1	> 0,42	-	113 Cement Grey
	FS ETNA WHITE	27231	33*33	9,5	BN-14	11	Gres Single fired	4	R-9	-	C1	> 0,42	-	113 Cement Grey
	FS FAENZA-A	13618	33*33	9,5	BN-14	3	Gres Single fired	4	R-9	-	C1	-	-	110 Manhattan
	FS FAENZA-N	13619	33*33	9,5	BN-14	3	Gres Single fired	4	R-9	-	C1	-	-	110 Manhattan
	FS FIELD BLACK LT	36382	45,2*45,2	-	-	10	Porcelánico Porcelain	-	R-11	A+B+C	C3	> 0,42	+36	110 Manhattan
	FS FIELD BLUE LT	36383	45,2*45,2	-	-	10	Porcelánico Porcelain	-	R-11	A+B+C	C3	> 0,42	+36	110 Manhattan
	FS FIELD BROWN LT	36384	45,2*45,2	-	-	10	Porcelánico Porcelain	-	R-11	A+B+C	C3	> 0,42	+36	110 Manhattan
	FS FOREST BLACK	34443	45*45	10,5	BN-14	10	Gres Single fired	-	R-9	-	C1	> 0,42	+36	114 Anthracite
	FS FOREST MIX	34445	45*45	10,5	BN-14	10	Gres Single fired	-	-	-	-	-	-	133 Sand
	FS FOREST NATURAL	34444	45*45	10,5	BN-14	10	Gres Single fired	-	R-9	-	C1	> 0,42	+36	133 Sand
	FS FOREST PLANK	34881	7,3*45	10,5	BN-146	48	Gres Single fired	-	-	-	-	-	-	133 Sand
	FS FOREST WHITE	34442	45*45	10,5	BN-14	10	Gres Single fired	-	R-9	-	C1	> 0,42	+36	110 Manhattan
	FS HERITAGE LEAVES LT	30895	45*45	10,5	BN-17	10	Gres Single fired	4	-	-	-	-	-	110 Manhattan
	FS HERITAGE ORNATE LT	30894	45*45	10,5	BN-17	10	Gres Single fired	4	-	-	-	-	-	110 Manhattan
	FS HERITAGE SQUARE LT	30893	45*45	10,5	BN-17	10	Gres Single fired	4	-	-	-	-	-	110 Manhattan
	FS HERITAGE WHITE LT	30892	45*45	10,5	BN-17	10	Gres Single fired	4	-	-	-	-	-	110 Manhattan















Modelo Model	Artículo Article	Referencia Reference	Formato Size	Espesor Thickness	Tarifa Price List	Gráficas Patterns	Tipo de Pasta Tile Body	ISO 10545-7 (PEI)	DIN 51130 (R)	DIN 51097 (A+B+C)	UNE 41 901 EX (CLASS)	ANSI A 131,1 (DCOF)	BS 7976-2 (WET)	Color de junta Color Join MAPEI
	FS IRON OXIDE LT	34446	20*40	10,3	BN-18	12	Pasta Blanca White Body	-	-	-	-	-	-	114 Anthracite
	FS IRON WHITE LT	34447	20*40	10,3	BN-18	12	Pasta Blanca White Body	-	-	-	-	-	-	114 Anthracite
	FS IVY BLACK	26170	45*45	10,5	BN-14	10	Gres Single fired	4	R-9	-	C1	> 0,42	+36	110 Manhattan
	FS IVY BLUE	26171	45*45	10,5	BN-14	10	Gres Single fired	4	R-9	-	C1	> 0,42	+36	110 Manhattan
	FS IVY SAGE	26172	45*45	10,5	BN-14	10	Gres Single fired	4	R-9	-	C1	> 0,42	+36	110 Manhattan
	FS JAIPUR BLACK LT	34438	45*45	10,5	BN-17	10	Gres Single fired	-	-	-	C1	-	-	114 Anthracite
	FS JAIPUR WHITE LT	34439	45*45	10,5	BN-17	10	Gres Single fired	-	-	-	C1	-	-	110 Manhattan
	FS LOFT BLACK	34450	20*40	10,3	BN-18	6	Pasta Blanca White Body	-	-	-	-	-	-	114 Anthracite
	FS LOFT CLAY	34451	20*40	10,3	BN-18	6	Pasta Blanca White Body	-	-	-	-	-	-	134 Silk
	FS LOFT WHITE	34449	20*40	10,3	BN-18	6	Pasta Blanca White Body	-	-	-	-	-	-	110 Manhattan
	FS MANISES-B	13621	33*33	9,5	BN-14	3	Gres Single fired	4	R-9	-	C1	-	-	110 Manhattan
	FS MARAIS	24268	45,2*45,2	10	BN-61	10	Porcelánico Porcelain	4	R-9	-	C1	>0,42	+36	110 Manhattan
	FS MARRAKECH BLUE	21936	45*45	10,5	BN-14	6	Gres Single fired	4	R-9	-	C1	>0,42	+36	113 Cement Grey
	FS MARRAKECH GREY	21937	45*45	10,5	BN-14	6	Gres Single fired	4	R-9	-	C1	>0,42	+36	113 Cement Grey
	FS MELVIN COLOR	20032	7,4*67,5	10,5	BN-73	90	Porcelánico Porcelain	4	R-9	-	C1	-	-	113 Cement Grey
	FS MELVIN WHITE	20033	7,4*67,5	10,5	BN-73	78	Porcelánico Porcelain	4	R-9	-	C1	-	-	113 Cement Grey
	FS MIRAMBEL-A	20300	33*33	9,5	BN-14	4	Gres Single fired	4	R-10	A+B	C2	>0,42	+36	110 Manhattan
	FS MIRAMBEL-B	20527	33*33	9,5	BN-14	4	Gres Single fired	4	R-10	A+B	C2	>0,42	+36	110 Manhattan

Modelo Model	Artículo Article	Referencia Reference	Formato Size	Espesor Thickness	Tarifa Price List	Gráficas Patterns	Tipo de Pasta Tile Body	ISO 10545-7 (PEI)	DIN 51130 (R)	DIN 51097 (A+B+C)	UNE 41 901 EX (CLASS)	ANSI A 131,1 (DCOF)	BS 7976-2 (WET)	Color de junta Color Join MAPEI
	FS MIRAMBEL-M	20301	33*33	9,5	BN-14	4	Gres Single fired	4	R-10	A+B	C2	>0,42	+36	110 Manhattan
	FS MUD COCOA	29760	20*40	10,3	BN-3	35	Pasta Blanca White Body	-	-	-	-	-	-	130 Jasmine
	FS MUD SAND	29761	20*40	10,3	BN-3	35	Pasta Blanca White Body	-	-	-	-	-	-	130 Jasmine
	FS MUD SILVER	29758	20*40	10,3	BN-3	35	Pasta Blanca White Body	-	-	-	-	-	-	110 Manhattan
	FS MUD WHITE	29759	20*40	10,3	BN-3	35	Pasta Blanca White Body	-	-	-	-	-	-	110 Manhattan
	FS NIJAR	20402	45*45	10,5	BN-14	6	Gres Single fired	3	R-10	A+B	C2	>0,42	+36	110 Manhattan
	FS NORWICH	22058	33*33	9,5	BN-61	21	Porcelánico Porcelain	4	R-9	-	C1	>0,42	-	113 Cement Grey
	FS OFELIA	21076	45,2*45,2	10	BN-61	180	Porcelánico Porcelain	4	R-10	A+B	C2	>0,42	+36	113 Cement Grey
	FS OLDKER	20302	33*33	9,5	BN-14	10	Gres Single fired	4	R-10	A+B	C1	-	+36	110 Manhattan
	FS PORTO AMARAL	31653	45*45	10,5	BN-14	10	Gres Single fired	4	R-9	-	C1	> 0,42	+36	110 Manhattan
	FS PORTO FATIMA	31654	45*45	10,5	BN-14	10	Gres Single fired	4	R-9	-	C1	> 0,42	+36	110 Manhattan
	FS PORTO FLAVIA	31655	45*45	10,5	BN-14	10	Gres Single fired	4	R-9	-	C1	> 0,42	+36	110 Manhattan
	FS PORTO IRIA	31656	45*45	10,5	BN-14	10	Gres Single fired	4	R-9	-	C1	> 0,42	+36	110 Manhattan
	FS RAKU BLACK	28941	20*40	10,3	BN-3	35	Pasta Blanca White Body	-	-	-	-	-	-	110 Manhattan
	FS RAKU BLUE	28939	20*40	10,3	BN-3	35	Pasta Blanca White Body	-	-	-	-	-	-	110 Manhattan
	FS RAKU COLORS	28944	20*40	10,3	BN-3	35	Pasta Blanca White Body	-	-	-	-	-	-	110 Manhattan
	FS RAKU CREAM	28942	20*40	10,3	BN-3	35	Pasta Blanca White Body	-	-	-	-	-	-	110 Manhattan
	FS RAKU SAGE	28940	20*40	10,3	BN-3	35	Pasta Blanca White Body	-	-	-	-	-	-	110 Manhattan

Modelo Model	Artículo Article	Referencia Reference	Formato Size	Espesor Thickness	Tarifa Price List	Gráficas Patterns	Tipo de Pasta Tile Body	ISO 10545-7 (PEI)	DIN 51130 (R)	DIN 51097 (A+B+C)	UNE 41 901 EX (CLASS)	ANSI A 131,1 (DCOF)	BS 7976-2 (WET)	Color de junta Color Join MAPEI
	FS RAKU SILVER	28943	20*40	10,3	BN-3	35	Pasta Blanca White Body	-	-	-	-	-	-	110 Manhattan
	FS RAKU WHITE	28938	20*40	10,3	BN-3	35	Pasta Blanca White Body	-	-	-	-	-	-	110 Manhattan
	FS ROAD MARS AS	36372	90*90	-	-	10	Porcelánico Porcelain	-	R-11	A+B+C	C3	> 0,42	+36	136 Mud
	FS ROAD MOON AS	36373	90*90	-	-	10	Porcelánico Porcelain	-	R-11	A+B+C	C3	> 0,42	+36	113 Cement Grey
	FS ROCK AS	36381	45,2*45,2	-	-	10	Porcelánico Porcelain	-	R-11	A+B+C	C3	> 0,42	+36	110 Manhattan
	FS ROCKSTAR-N AS	36379	45,2*45,2	-	-	10	Porcelánico Porcelain	-	R-11	A+B+C	C3	> 0,42	+36	110 Manhattan
	FS ROMBOS-N	16447	45*45	10,5	BN-14	4	Gres Single fired	4	R-9	-	C1	>0,42	+36	110 Manhattan
	FS ROOTS-0	29295	45*45	10,5	BN-14	7	Gres Single fired	4	R-9	-	C1	>0,42	+36	110 Manhattan
	FS ROOTS-1	28888	45*45	10,5	BN-14	7	Gres Single fired	4	R-9	-	C1	>0,42	+36	110 Manhattan
	FS ROOTS-2	28889	45*45	10,5	BN-14	7	Gres Single fired	4	R-9	-	C1	>0,42	+36	110 Manhattan
	FS ROOTS-3	28890	45*45	10,5	BN-14	7	Gres Single fired	4	R-9	-	C1	>0,42	+36	110 Manhattan
	FS ROOTS-4	28891	45*45	10,5	BN-14	7	Gres Single fired	4	R-9	-	C1	>0,42	+36	110 Manhattan
	FS RUE	24266	45,2*45,2	10	BN-61	16	Porcelánico Porcelain	4	R-9	-	C1	>0,42	+36	110 Manhattan
	FS SABI	32446	45*45	10,5	BN-14	10	Gres Single fired	4	R-9	-	C1	>0,42	+36	110 Manhattan
	FS SAJA-B	20087	33*33	9,5	BN-14	7	Gres Single fired	3	-	-	C1	-	-	110 Manhattan
	FS SAJA-N	20086	33*33	9,5	BN-14	9	Gres Single fired	3	-	-	C1	-	-	114 Anthracite
	FS SEA BLUE LT	32444	33*33	9,5	BN-17	10	Gres Single fired	3	-	-	-	-	-	110 Manhattan
	FS SEA WHITE LT	32445	33*33	9,5	BN-17	10	Gres Single fired	3	-	-	-	-	-	110 Manhattan

Modelo Model	Artículo Article	Referencia Reference	Formato Size	Espesor Thickness	Tarifa Price List	Gráficas Patterns	Tipo de Pasta Tile Body	ISO 10545-7 (PEI)	DIN 51130 (R)	DIN 51097 (A+B+C)	UNE 41 901 EX (CLASS)	ANSI A 131,1 (DCOF)	BS 7976-2 (WET)	Color de junta Color Join MAPEI
	FS SEAL	30066	45*45	10,5	BN-14	10	Gres Single fired	4	R-9	-	C1	>0,42	+36	110 Manhattan
	FS SEATTLE	18152	30*30	8	BN-61	26	Porcelánico Porcelain	3	R-9	-	C1	-	-	110 Manhattan
	FS SENA BLUE	24267	45,2*45,2	10	BN-61	6	Porcelánico Porcelain	3	R-9	-	C1	>0,42	+36	110 Manhattan
	FS STAR ARA BLACK	28148	45*45	10,5	BN-14	9	Gres Single fired	4	R-9	-	C1	>0,42	+36	110 Manhattan
	FS STAR BLACK LT	32447	45*45	10,5	BN-17	10	Gres Single fired	3	R-10	-	C2	>0,42	+36	110 Manhattan
	FS STAR BLUE	23200	45*45	10,5	BN-14	9	Gres Single fired	4	R-9	-	C1	>0,42	+36	110 Manhattan
	FS STAR BLUE LT	32448	45*45	10,5	BN-17	10	Gres Single fired	3	R-10	-	C2	>0,42	+36	110 Manhattan
	FS STAR NIGHT	28146	45*45	-	-	10	Gres Single fired	-	R-9	-	C1	> 0,42	+36	114 Anthracite
	FS STAR OXIDE	23198	45*45	10,5	BN-14	9	Gres Single fired	4	R-9	-	C1	>0,42	+36	110 Manhattan
	FS STAR SAGE	23199	45*45	10,5	BN-14	9	Gres Single fired	4	R-9	-	C1	>0,42	+36	110 Manhattan
	FS STAR SAGE LT	32449	45*45	10,5	BN-17	10	Gres Single fired	3	R-10	-	C2	>0,42	+36	110 Manhattan
	FS STAR SKY	28147	45*45	-	-	10	Gres Single fired	-	R-9	-	C1	> 0,42	+36	110 Manhattan
	FS STAR WHITE	27325	45*45	10,5	BN-14	10	Gres Single fired	4	R-9	-	C1	> 0,42	+36	110 Manhattan
	FS STAR WHITE LT	33214	45*45	10,5	BN-17	10	Gres Single fired	4	R-10	-	C2	>0,42	+36	110 Manhattan
	FS STAR-N	19136	45*45	10,5	BN-14	9	Gres Single fired	4	R-9	-	C1	>0,42	+36	110 Manhattan
	FS TEMPLE BLACK	24713	45*45	10,5	BN-14	10	Gres Single fired	4	R-9	-	C1	>0,42	+36	110 Manhattan
	FS TEMPLE BLUE	24716	45*45	10,5	BN-14	10	Gres Single fired	4	R-9	-	C1	>0,42	+36	110 Manhattan
	FS TEMPLE OXIDE	24715	45*45	10,5	BN-14	10	Gres Single fired	4	R-9	-	C1	>0,42	+36	110 Manhattan

Modelo Model	Artículo Article	Referencia Reference	Formato Size	Espesor Thickness	Tarifa Price List	Gráficas Patterns	Tipo de Pasta Tile Body	ISO 10545-7 (PEI)	DIN 51130 (R)	DIN 51097 (A+B+C)	UNE 41 901 EX (CLASS)	ANSI A 131,1 (DCOF)	BS 7976-2 (WET)	Color de junta Color Join MAPEI
	FS TEMPLE SAGE	24714	45*45	10,5	BN-14	10	Gres Single fired	4	R-9	-	C1	>0,42	+36	110 Manhattan
	FS TRADITION BRICK BLUE LT	30898	20*40	10,3	BN-18	30	Pasta Blanca White Body	-	-	-	-	-	-	110 Manhattan
	FS TRADITION BRICK GREEN LT	31131	20*40	10,3	BN-18	30	Pasta Blanca White Body	-	-	-	-	-	-	110 Manhattan
	FS TRADITION BRICK SILVER LT	30897	20*40	10,3	BN-18	30	Pasta Blanca White Body	-	-	-	-	-	-	110 Manhattan
	FS TRADITION BRICK WHITE LT	30961	20*40	10,3	BN-18	30	Pasta Blanca White Body	-	-	-	-	-	-	110 Manhattan
	FS TRADITION SQUARE BLUE LT	30899	20*40	10,3	BN-18	30	Pasta Blanca White Body	-	-	-	-	-	-	110 Manhattan
	FS TRADITION SQUARE GREEN LT	31132	20*40	10,3	BN-18	30	Pasta Blanca White Body	-	-	-	-	-	-	110 Manhattan
	FS TRADITION SQUARE SILVER LT	30962	20*40	10,3	BN-18	30	Pasta Blanca White Body	-	-	-	-	-	-	110 Manhattan
	FS TRADITION SQUARE WHITE LT	30896	20*40	10,3	BN-18	30	Pasta Blanca White Body	-	-	-	-	-	-	110 Manhattan
	FS VENDOME	24269	45,2*45,2	10	BN-61	16	Porcelánico Porcelain	4	R-9	-	C1	>0,42	+36	110 Manhattan
	FS VENEZIA/46	21078	45,2*45,2	10	BN-61	21	Porcelánico Porcelain	4	R-11	A+B	C2	>0,42	+36	113 Cement Grey
	FS VENEZIA/60X60/R	25659	60*60	10	BN-91	16	Porcelánico Porcelain	4	R-11	A+B	C2	>0,42	+36	113 Cement Grey
	FS WABI	32443	33*33	9,5	BN-14	10	Gres Single fired	4	R-9	-	C1	>0,42	+36	110 Manhattan
	FS WABI ARROW	32442	33*33	9,5	BN-14	10	Gres Single fired	4	R-9	-	C1	>0,42	+36	110 Manhattan
	FS WILD AS	36330	19,5*121,5	-	-	30	Porcelánico Porcelain	-	R-11	A+B+C	C3	> 0,42	+36	110 Manhattan
	FS YARD BLACK	26173	45*45	10,5	BN-14	10	Gres Single fired	4	R-9	-	C1	> 0,42	+36	110 Manhattan
	FS YARD BLUE	26174	45*45	10,5	BN-14	10	Gres Single fired	4	R-9	-	C1	> 0,42	+36	110 Manhattan
	FS YARD SAGE	26175	45*45	10,5	BN-14	10	Gres Single fired	4	R-9	-	C1	> 0,42	+36	110 Manhattan

Modelo Model	Artículo Article	Referencia Reference	Formato Size	Espesor Thickness	Tarifa Price List	Gráficas Patterns	Tipo de Pasta Tile Body	ISO 10545-7 (PEI)	DIN 51130 (R)	DIN 51097 (A+B+C)	UNE 41 901 EX (CLASS)	ANSI A 131,1 (DCOF)	BS 7976-2 (WET)	Color de junta Color Join MAPEI
	L FS BRASS/22,3	27779	1*22,3	10	P-43	-	Pasta Blanca White Body	-	-	-	-	-	-	110 Manhattan
	L FS RAKU GOLD/1,5X20	29177	1,5*20	8	P-14	-	Pasta Blanca White Body	-	-	-	-	-	-	110 Manhattan
	M FS MANISES-A	13668	5*11	-	P-22	-	Gres Single fired	-	-	-	-	-	-	110 Manhattan
	M FS MANISES-B	13670	5*11	-	P-22	-	Gres Single fired	-	-	-	-	-	-	110 Manhattan
	M FS MANISES-N	13669	5*11	-	P-22	-	Gres Single fired	-	-	-	-	-	-	110 Manhattan
	R FS-0	13502	8*45	8	P-8	-	Gres Single fired	-	-	-	-	-	-	110 Manhattan
	R FS ALORA	19406	8*45	8	P-8	-	Gres Single fired	-	-	-	-	-	-	113 Cement Grey
	R FS OFELIA	24278	8*45,2	10	P-29	-	Porcelánico Porcelain	-	-	-	-	-	-	113 Cement Grey
	R FS ROOTS-0	29622	8*45	8	P-8	-	Gres Single fired	-	-	-	-	-	-	110 Manhattan
	R FS SEATTLE	19739	7,5*30	8	P-9	-	Porcelánico Porcelain	-	-	-	-	-	-	110 Manhattan
	R FS VENEZIA	37533	8*60	10	P-34	-	Porcelánico Porcelain	-	-	-	-	-	-	113 Cement Grey
	R FS WILD	37080	8*60	10	P-34	-	Porcelánico Porcelain	-	-	-	-	-	-	110 Manhattan
	T.FS FAENZA-A	13717	11*11	9,5	P-6	12	Gres Single fired	-	-	-	-	-	-	110 Manhattan
	T.FS FAENZA-N	13719	11*11	9,5	P-6	12	Gres Single fired	4	R-9	-	C1	-	-	110 Manhattan
	T.FS MANISES-B	13720	11*11	9,5	P-6	12	Gres Single fired	-	-	-	-	-	-	110 Manhattan

ADDITIONAL

NORMATIVA_ REGULATION	386
MANIPULADO_ HANDLING	388
LIMPIEZA_ CLEANING	390
ICONOGRAFÍA_ ICONOGRAPHY	391

info

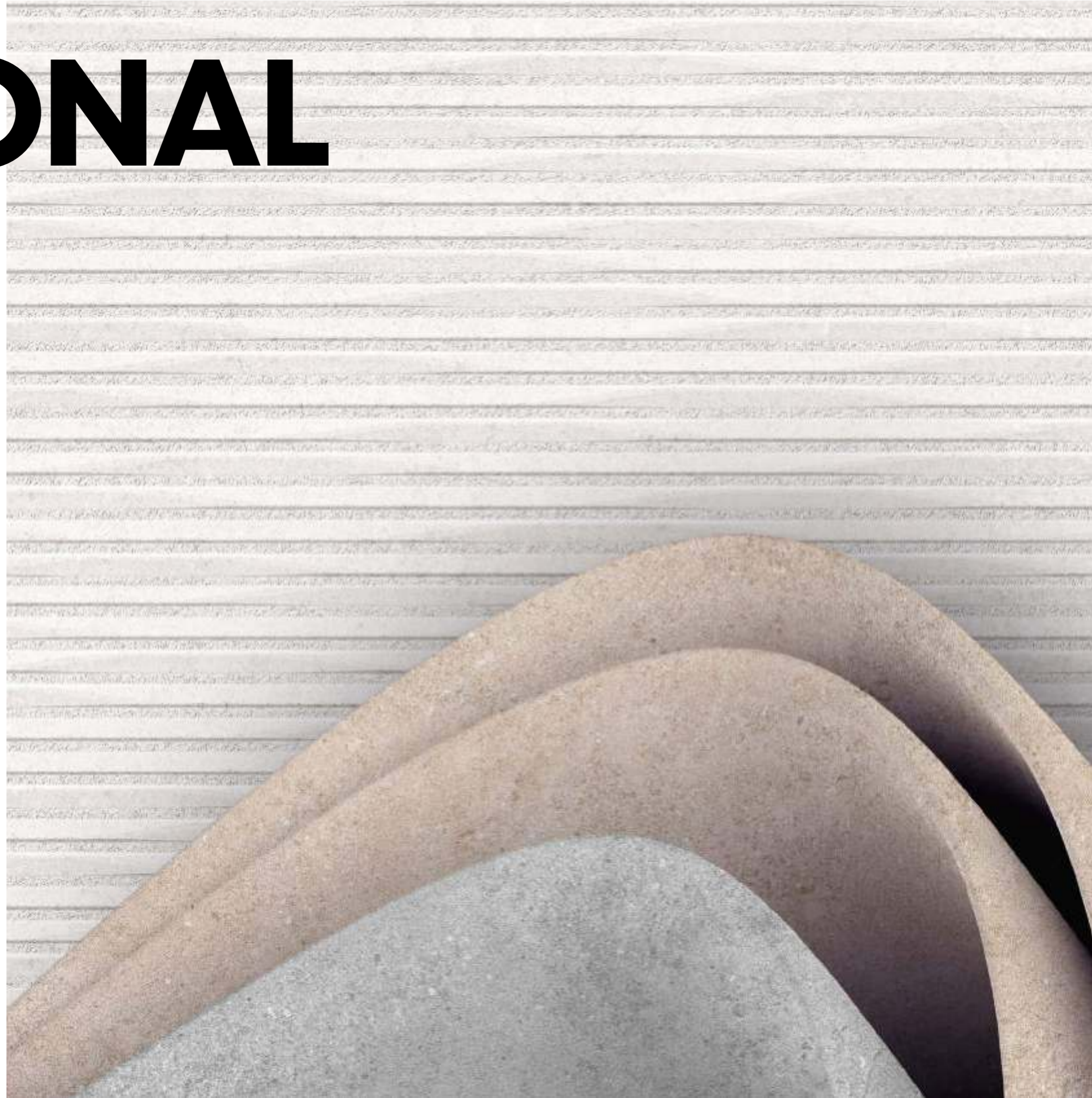

Normas de producto acabado ·

Según la norma de especificaciones UNE-EN-14411, nuestros productos pertenecen a los siguientes grupos:

GRES PORCELÁNICO: grupo Bla, baldosas prensadas en seco, con una absorción de agua E≤0.5%.

GRES: grupo BIIa, baldosas prensadas en seco, 3<E≤6%.

REVESTIMIENTO: grupo BIII, baldosas en seco, E>10%.

Normas de ensayo

ISO 10545-2: Determinación de las dimensiones

Establece métodos para la determinación de las características dimensionales (longitud, anchura, grosor, rectitud de lados, ortogonalidad y planitud de superficie).

ISO 10545-3: Determinación de la absorción de agua

La absorción de agua es una medida de la mayor o menor porosidad del soporte cerámico. El ensayo determina la cantidad de agua que absorben las piezas, sumergidas en agua a ebullición durante dos horas. Se expresa en % de agua absorbida respecto a la masa en seco de las piezas.

ISO 10545-4: Determinación de la resistencia a la flexión

Se determina la resistencia a la flexión de una baldosa, aplicando una fuerza en el centro de la cara vista. La fuerza aplicada va en aumento hasta conseguir romper la baldosa. La resistencia a la flexión se expresa en N/mm².

ISO 10545-7: Determinación de la abrasión superficial de las baldosas esmaltadas

Determinación de la resistencia a la abrasión del esmalte de las baldosas, por rotación de una carga abrasiva sobre la superficie y comparación visual de baldosas sometidas y no sometidas al ensayo. La clasificación varía de PEI 1 hasta 5.

Para el uso correcto de un pavimento cerámico, hay que conocer la resistencia al desgaste del mismo. La cual está influenciada, no sólo por sus características, sino también por el lugar donde se va a instalar. La presencia de materiales abrasivos (arena, gravilla, ...), así como los locales con acceso directo desde el exterior, son factores que acortan la duración del pavimento.

Nuestros pavimentos han sido clasificados en cinco grupos, que establecen su resistencia a la abrasión y al desgaste:

PEI 1: Pavimentos sometidos a tráfico ligero, donde se utiliza calzado suave y exento de productos abrasivos. Recomendado en dormitorios y cuartos de baño de viviendas privadas, sin contacto con el exterior.

PEI 2: Pavimentos sometidos a tráfico medio-ligero, donde se utiliza calzado suave. Recomendado en todas las viviendas unifamiliares con excepción de cocinas, entradas, escaleras y terrazas.

PEI 3: Pavimentos sometidos a tráfico medio, donde se utiliza calzado normal. Recomendado en todas las habitaciones de las viviendas privadas y de hoteles, a excepción de las zonas comunes, como escaleras, entradas, etc.

PEI 4: Pavimentos sometidos a tráfico medio-alto. Recomendado en todo tipo de viviendas colectivas y unifamiliares, terrazas, cocinas, despachos y oficinas. No pertenecen a este grupo todos los lugares públicos sometidos a tráfico intenso, como estancos, puestos de periódicos, panaderías, barras de bar, estaciones de transporte público, etc.

PEI 5: Pavimentos adaptados a tráfico muy intenso. Recomendado en centros comerciales, estaciones, aeropuertos, etc.

ISO 10545-9: Resistencia al choque térmico

Determinación de la resistencia al choque térmico de una baldosa entera sometida a diez ciclos de variación de temperatura entre 15°C y 145°C .

EN-101: Dureza superficial

La dureza superficial determina la capacidad de resistencia de la superficie del esmalte al rayado. Las baldosas se clasifican en una escala de 1 a 10 en función de la dureza creciente de los minerales utilizados para rayarla.

La escala de dureza MOHS es la siguiente:

1 talco - 2 yeso - 3 calcita - 4 fluorita - 5 apatito - 6 feldespato - 7 cuarzo - 8 topacio - 9 corindón - 10 diamante.

ISO 10545-11: Determinación de la resistencia al cuarteo

Determinación de la resistencia a la formación de fisuras del esmalte, sometiendo baldosas enteras al vapor, a la presión de 5 Kg/cm² en un autoclave y después examinándolas en busca de fisuras tras la aplicación de un tinte en la cara esmaltada.

ISO 10545-12: Determinación de la resistencia a la helada

Establece un método mediante el cual, se impregnan de agua las baldosas enteras y se someten posteriormente a 100 ciclos de congelación-deshielo, entre + 5°C y - 5°C.

DIN-51130: Determinación del ángulo crítico de deslizamiento. Rampa

Este método también se llama “método de la rampa inclinada”. Sobre una plataforma, que se puede regular en altura, se colocan las baldosas a ensayar ocupando una superficie total de 100 cm x 50 cm. Seguidamente se aplica uniformemente una capa de aceite sobre dicha superficie y en las suelas de los zapatos del técnico que realizará el ensayo.

La plataforma, sobre la que camina un técnico, incrementa progresivamente el ángulo respecto de la horizontal, hasta que detecta indicios de deslizamiento. Como resultado se obtiene el ángulo máximo que permite una circulación segura sobre el pavimento.

Ángulo	Grupo
6°< a <10°	R9
10°< a <19°	R10
19°< a <27°	R11
27°< a <35°	R12
35°< a	R13

UNE-41901 EX: Determinación del valor de la resistencia al deslizamiento. Péndulo

El equipo consiste en un péndulo de longitud de brazo 510 mm, que soporta un deslizador de caucho de dimensiones 76x25 mm. La altura del equipo se ajusta para conseguir que el deslizador, mantenga el contacto con la superficie durante un recorrido de 126+1 mm.

La muestra se sumerge en agua durante un mínimo de 30 minutos previamente al ensayo. Cada baldosa se ensaya en dos direcciones opuestas (0° y 180°) estando su superficie saturada de agua destilada.

Rd	Clase
Rd < 15	0
15< Rd <35	1
35< Rd <45	2
Rd>45	3

ISO 10545-13: Determinación de la resistencia química

Dicho ensayo determina, por separado, la resistencia química de las baldosas, a los agentes de limpieza, sales de piscina, ácidos y álcalis. Con la exclusión del ácido fluorhídrico (HF) y sus compuestos.

La clasificación visual para ácidos y álcalis de concentración fuerte varía desde HA, HB y HC, para ácidos y bases de concentración débil desde LA, LB y LC, y para productos de limpieza y sales de piscina entre A, B y C, en función de la resistencia química.

A – Sin efecto visible,
B – Clara modificación del aspecto,
C – Pérdida parcial o completa del aspecto de la superficie original.

ISO 10545-14: Determinación de la resistencia a las manchas

Determinación de la resistencia a la mancha, manteniendo la cara vista en contacto con diversas soluciones de ensayo, durante 24 horas. Transcurridas las mismas, se limpia la superficie de las baldosas con diferentes agentes de limpieza. Y finalmente, se examinan para detectar cambios irreversibles de aspecto. La clasificación varía de 5 a 1. Siendo el 5, cuando las baldosas se limpian fácilmente y el 1, cuando es imposible limpiar la superficie.

Clasificación según el nivel de radioactividad: Clase A (norma GB 6566)

Finished product standards ·

According to the UNE-EN-14411 specifications standard, our products belong to the following groups:

PORCELAIN TILES: Group Bla, dry-pressed tiles, with a rate of water absorption E≤0.5%.

FLOOR TILES: Group BIIa, dry-pressed tiles, 3<E≤6%.

WALL TILES: Group BIII, dry-pressed tiles, E>10%.

Test standards

ISO 10545-2: Determination of dimensions

Sets forth the methods for determining dimensional characteristics (length, width, thickness, straightness of sides, rectangularity and surface planarity).

ISO 10545-3: Determination of water absorption

Water absorption is a measure of the greater or lesser rate of porosity of the tile body. The test determines the amount absorbed by pieces, after being submerged in boiling water for two hours.

The rate of water absorption is expressed as a % with respect to the dry mass of pieces.

ISO 10545-4: Determination of bending strength

A tile's bending strength is determined by applying a force on the middle of the top side of the piece. The force applied is increased until the tile breaks. Bending strength is expressed in N/mm².

ISO 10545-7: Determination of the surface abrasion resistance of glazed tiles

The resistance of the glazed layer of tiles to abrasion is determined by applying a rotating abrasive load on the tile surface and visually inspecting pieces that have undergone testing against those that have not. Classification ranges from PEI 1 to 5.

In order to determine the suitability of ceramic floor tiles, their wear resistance must be known. This is influenced by not only the characteristics of tiles, but also by the place where they will be installed. The presence of abrasive materials (sand, gravel, etc.) and locations in areas with direct outdoor access are factors which shorten the lifespan of floor tiles.

Our floor tiles have been classified into five groups, which determine their resistance to abrasion and wear:

PEI 1: Floor tiles exposed to light traffic, on which soft-soled footwear is used, free from abrasive products Recommended in bedrooms and bathrooms in private homes, with no direct outside entry.

PEI 2: Floor tiles exposed to average to light traffic, on which soft-soled footwear is used.

Recommended for all rooms in single-family homes except kitchens, entranceways, stairways and terraces.

PEI 3: Floor tiles exposed to average traffic, on which normal footwear is used. Recommended for all rooms in private homes and hotels, except for common areas such as stairways, entrances, etc.

PEI 4: Floor tiles exposed to average to heavy traffic. Recommended for all types of single-family homes and multiunit dwellings, terraces, kitchens, business premises and offices. Not belonging to this group are all public places exposed to intense traffic such as tobacconists’, news stands, bakeries, bar areas, public transport stations, etc.

PEI 5: Floor tiles adapted to highly intense traffic. Recommended in shopping centres, train/bus stations, airports, etc.

ISO 10545-9: Determination of resistance to thermal shock

Determination of the resistance to thermal shock by cycling complete sample tiles ten times between 15°C and 145°C.

EN-101: Surface hardness

Surface hardness determines the capacity of resistance of the glazed surface to scratching. Tiles are classified on a scale of 1 to 10 based on the increasing hardness of the minerals used to scratch their surface.

The MOHS hardness scale is as follows:

1 talc - 2 gypsum - 3 calcite - 4 fluorite - 5 apatite - 6 feldspar - 7 quartz - 8 topaz - 9 corundum - 10 diamond.

ISO 10545-11: Determination of crazing resistance

Determination of the resistance to the formation of fissures in the glazed layer by subjecting whole tiles to steam at a pressure of 5 Kg/cm² in an autoclave, after which a dye is applied to the glazed layer and tiles are examined to detect possible fissures.

ISO 10545-12: Frost resistance

This establishes a method whereby whole tiles are soaked in water and then undergo 100 freezing-thaw cycles, between + 5°C and - 5°C.

DIN-51130: Determination of the critical slippage angle. Ramp

This method is called “sloping ramp method”, too. The tiles to be test must be installed on a platform that you could adjust the high, taking a total room of 100 cm. x 50 cm. Immediately after, a coat of oil is applied on the surface and on the soles of the technician, who will make the test. The technician walks on the platform, which will increase the angle from the horizontal gradually. Until, the slippery signs will be detected by the technician.

As a result of this test, we get the maximum angle to permit a safe traffic on the tile. Angle Group.

Angle	Group
6°< a <10°	R9
10°< a <19°	R10
19°< a <27°	R11
27°< a <35°	R12
35°< a	R13

UNE-41901 EX: Determination of slip resistance rating. Pendulum

The equipment consists of a pendulum whose arm measures 510 mm., to which a 76x25 mm. rubber slider is attached. Pendulum height is adjusted so that the slider remains in contact with the surface for a run of 126 mm. +/- 1 mm.

The sample is submerged in water for a minimum of 30 minutes prior to testing. Each tile is tested in two opposite directions (0° and 180°), with the tile surface being

Rd	Class
Rd < 15	0
15< Rd <35	1
35< Rd <45	2
Rd>45	3

ISO 10545-13: Determination of chemical resistance

This test determines the chemical resistance of tiles to cleaning agents, swimming pool additives, acids and alkalis, except for hydrofluoric acid (HF) and its compounds.

The visual classification of high concentrated acids and alkalis can be HA/HB/ HC; low concentrated acids and alkalis can be LA/LB/LC; cleaning products and swimming pool salts can be A/B/C, according to the chemical resistance grading.

A – No visible effect
B – Noticeable/obvious appearance modification
C – Partial or complete loss of surface appearance

ISO 10545-14: Determination of resistance to stains

Determination of resistance to stains by maintaining the tile face in contact with different test solutions during 24 hours. Once such time has passed, tile surface

is cleaned with different cleaning agents. Finally, tiles are examined in order to determine irreversible changes in aspect. The classification rate varies from 5 to 1. Number 5 is achieved when tiles can be easily cleaned and number 1 corresponds to those tiles, whose surface is almost impossible to be cleaned.

Clasification according the radioactive level: Class A (norm GB 6566)

COMPRUEBA EL ALBARÁN Y VERIFICA EL PRODUCTO ·

Revisa que el material recibido se ajusta al pedido de compra realizado. En el exterior de la caja dispones de toda la información relevante para realizar esta comprobación.

PREPARA LOS MATERIALES QUE VAS A NECESITAR ·

Asegúrate de disponer de las herramientas necesarias para realizar la correcta colocación de material. A saber:

- Cemento de agarre
- Ventosas
- Nivel manual tiralíneas y flexómetro
- Cuñas de nivelación
- Crucetas
- Pasta de rejunte
- Paleta
- Llana dentada de 10mm
- Cubo, esponja y fregona
- Llana de limpieza
- Mazo de goma blanca
- Pinza de tracción ajustable

PRIMERO EL REVESTIMIENTO ·

Comenzaremos la colocación del revestimiento para no generar posibles desperfectos al pavimento en su colocación. Para ello respetaremos el espacio necesario para su posterior instalación.

COMPRUEBA LA NIVELACIÓN ·

En caso de observarse pequeños desniveles aconsejamos el uso de mortero de nivelación, también conocido como autonivelante, para asegurar una superficie homogénea, lisa, sólida y compatible con los adhesivos utilizados en la instalación de cerámica. El tipo de autonivelante y el espesor de la capa a utilizar dependerá del uso (interior/exterior), del tránsito previsto y del desnivel a compensar posibles desperfectos al pavimento en su colocación. Para ello respetaremos el espacio necesario para su posterior instalación.

COMPRUEBA QUE LA SUPERFICIE ESTÉ EXENTA DE POLVO ·

Para una correcta adhesión de la pieza se debe comprobar que la superficie esté limpia de polvo, cal, grasas y humedad.

PLANTEA LA LINEA MAESTRA ·

La línea maestra debe ser paralela al pavimento. Te ayudará a plantear la instalación y a optimizar la cantidad de material cerámico utilizado.

MANIPULA CORRECTAMENTE LAS PIEZAS ·

Ajusta la manipulación al tamaño de la pieza. Los grandes formatos deben ser transportados por dos personas evitando la flexión de la pieza en aquellas piezas de espesor fino. Para ayudar en este proceso puedes ayudarte de ventosas.

SELECCIONA LA DISPOSICIÓN DE LAS PIEZAS ·

En Peronda trabajamos colecciones con gran variedad de gráficas para dotar de la mayor naturalidad a las estancias. Es recomendable plantear las distintas piezas en la superficie antes de aplicar el cemento de agarre para asegurar una estética óptima.

SELECCIONA EL CEMENTO DE AGARRE SIGUIENDO LAS INDICACIONES ·

Es necesario el uso de cemento cola para la correcta colocación de las baldosas. Existen cementos con diferentes propiedades de elasticidad y adherencia que varían en función del material a colocar, del lugar de instalación y de la climatología. Aconsejamos cementos C1 para revestimiento interior de porosa blanca y C2 para revestimiento y pavimento interior y exterior de porcelánico.

EXTIENDE EL CEMENTO DE AGARRE SOBRE LA SUPERFICIE YA NIVELADA ·

Siguiendo la línea maestra debemos extender con ayuda de la llana dentada el cemento de agarre sobre la superficie ya compactada y nivelada.

REPARTE EL CEMENTO SOBRE LA PIEZA CERÁMICA ·

Realizaremos el llamado doble encolado aplicando, además de sobre las paredes y suelo, también sobre la costilla cerámica el cemento cola. Debemos asegurarnos de que la capa de cemento es homogénea en todas las piezas y aplicarla con la llana dentada en dirección perpendicular al lado largo de la pieza.

INSTALA LA PIEZA ·

Siguiendo la línea maestra colocaremos la pieza apoyándonos con la maza de goma, dando ligeros golpes que ayuden a salir las pequeñas bolsas de aire que puedan haber quedado dentro del cemento cola. Debemos respetar una junta mínima de 2 mm entre piezas. Para ello nos ayudaremos de crucetas de separación.

SISTEMA DE NIVELACIÓN ·

Recomendamos los sistemas de nivelación de las empresas Raimondi, Peygran o Rubi, entre otras. Todas ellas disponen de un sistema de clips y cuñas aplicadas con pinzas de tracción que asegura la correcta colocación del material.

RESPETA LAS JUNTAS MÍNIMAS ·

El tamaño de la junta depende de los siguientes usos.

	PAVIMENTO INTERIOR	REVESTIMIENTO INTERIOR	PAVIMENTO EXTERIOR	FACHADAS
JUNTA DE COLOCACIÓN	> 0,5 mm > 2 mm para grandes formatos	> 1,5 mm	> 0,5 mm > 2 mm para grandes formatos	> 2,5 mm
JUNTA PERIMETRAL	> 5 mm	> 5 mm	> 5 mm	> 5 mm
JUNTA DE PARTICIÓN	> 5 mm	> 5 mm	> 5 mm	8 -10 mm
JUNTA ESTRUCTURAL	La misma que la junta estructural de soporte		La misma que la junta estructural de soporte, incluyendo cordón de poliuretano o perfil de compensación 6 a 35 mm	

RESPETA EL TIEMPO DE SECADO ·

Por lo general deberemos dejar un tiempo de secado de 24 horas, aunque para información más específica debemos atenernos a las recomendaciones de tiempo de secado del fabricante del cemento cola utilizado en la instalación.

SELECCIONA EL MATERIAL DE REJUNTE ·

De acuerdo con la UNE EN 13888, Es indispensable adecuar el material de rejunte al tipo de junta y a las condiciones de la superficie. Dividimos entre uso interior y exterior. Se presenta a continuación un cuadro en el que se detalla la tipología de rejunte a utilizar.

- CG1 – Rejuntado cementoso normal
- CG2 – Rejuntado cementoso mejorado
- RG – Resina sintética (epoxi generalmente)

	PAVIMENTO INTERIOR	PAVIMENTO EXTERIOR	REVESTIMIENTO INTERIOR	FACHADAS
JUNTA DE COLOCACIÓN	CG2	CG2 RG para usos alimentarios, sanitarios y de agresividad química	CG1, CG2, RG en zonas húmedas	CG2
JUNTA PERIMETRAL	Mínimo CG2	Mínimo CG2 RG para usos alimentarios, sanitarios y de agresividad química	Mínimo CG2	Mínimo CG2
JUNTA DE PARTICIÓN	Mínimo CG2	Mínimo CG2 RG para usos alimentarios, sanitarios y de agresividad química	Mínimo CG2	Mínimo CG2
JUNTA ESTRUCTURAL	Mínimo CG2	Mínimo CG2 RG para usos alimentarios, sanitarios y de agresividad química	Mínimo CG2	Mínimo CG2

PREPARA Y APLICA EL MATERIAL DE REJUNTE ·

La preparación es similar al cemento cola. Se mezcla con agua a proporciones indicadas por el fabricante. La colocación se realiza en la separación entre piezas utilizando una llana de rejuntado. Importante respetar los tiempos de recado recomendados por el fabricante de rejunte.

RETIRA EL MATERIAL SOBRANTE Y LIMPIA LA SUPERFICIE ·

Tras la colocación es esencial una correcta limpieza de sobrantes de rejunte y restos de obra. Es esencial retirarlo antes de que se endurezca. Para ello evitaremos utilizar el producto Fila Deterdek o el producto Fila CR10 en el caso de juntas epoxi. A continuación se recomiendan los productos a utilizar para un correcto mantenimiento de la cerámica instalada.

CHECK THE DELIVERY NOTE AND THE PRODUCTS ·

Make sure that the delivered goods coincide with the order. The outside of the box shows all the information you need to carry out these checks.

PREPARE THE REQUIRED MATERIALS ·

Make sure you have the required tools to lay the tiles. That is:

- Bonding adhesive
- Suction pads
- Spirit level, chalk line reel, tape measure
- Levelling wedges
- Spacers
- Grouting material
- Trowel
- 10 mm notched trowel
- Bucket, sponge and mop
- Foam-rubber cleaning float
- White rubber mallet
- Adjustable tile levelling pliers

FIRST LAY THE WALL TILES ·

Start by laying the wall tiles to avoid damaging the flooring. Make sure that enough space is left to lay the floor tiles afterwards.

CHECK THAT THE SUBSTRATE IS LEVEL ·

In the event of a slightly uneven substrate, use a self-levelling mortar to create a uniform, flat, solid surface compatible with the bonding adhesive used to lay the tiles. The type of self-levelling mortar and thickness of the layer will depend on its application (indoors/outdoors), the envisaged traffic, and the original unevenness.

CHECK THAT THE SUBSTRATE IS DUST-FREE ·

To ensure a firm bond between the tiles and the substrate, check that the surface is free from dust, plaster or lime, grease and moisture.

MARK A STRAIGHT LINE WITH THE CHALK LINE ·

Mark a straight line with the chalk line parallel to the tiles to be laid. This will act as a reference when the tiles are laid, while also helping to optimize the number of tiles you use.

HANDLE THE TILES PROPERLY ·

How they are handled will depend on the size of the tiles. Large-format tiles should be carried by two people. In the case of slimline materials, do not allow them to sag or bow in the middle. To assist in the process, suction pads can be used.

PLAN THE LAYOUT OF THE TILES ·

Peronda's collections feature a wide variety of different designs to bring greater realism to living spaces. For optimum end results, plan the layout of the tiles by positioning them on the surface to see what they look like before applying the bonding adhesive.

FOLLOW THE INDICATIONS WHEN CHOOSING THE BONDING ADHESIVE ·

The appropriate cement-based adhesive for the tiles must be used, given that there are ones with different elasticities and bonding strengths to suit different types of tiles, the place where they are laid, and the climate. We recommend the use of C1 cement-based adhesives for porous white-body indoor wall tiles and C2 adhesives for indoor and outdoor porcelain wall and floor tiles.

SPREAD THE BONDING ADHESIVE ACROSS THE LEVELLED SUBSTRATE ·

Using a notched trowel, spread the bonding adhesive across the level compact substrate.

SPREAD THE BONDING ADHESIVE ACROSS THE BACK OF THE TILES ·

Use the floating and buttering method—not only applying the adhesive to the wall and floor surfaces but also spreading it across the back of the tiles. Make sure that a uniform layer is applied to all the tiles, using the notched trowel to spread it perpendicular to the long side of the tile.

LAY THE TILES ·

Using the chalk line as a reference, lay the tiles on top of the bed of adhesive and tap them with a rubber mallet to release any tiny air bubbles that might be trapped in the adhesive.

Leave a tile joint of at least 2 mm between the tiles, using spacers to maintain the same distance.

LEVELLING SYSTEM ·

When rectified tiles are laid, the Raimondi, Peygran or Rubi levelling systems should be used. This system of clips and tile wedges, fitted with tile levelling pliers, ensures a level tile surface.

INSERT THE NECESSARY JOINTS ·

The width of the joints will depend on the following uses:

	INDOOR FLOORS	INDOOR WALLS	OUTDOOR FLOORS	FAÇADES
TILE JOINT	>0,5 mm >2 mm for big formats	>1,5 mm	>0,5 mm >2 mm for big formats	>2,5 mm
PERIMETE JOINT	>5 mm	>5 mm	>5 mm	>5 mm
PARTITION JOINT	>5 mm	>5 mm	>5 mm	8-10 mm
STRUCTURAL JOINT	The same as the structural joint in the substrate		The same as the structural joint in the substrate, including a 6-35mm compensation profile or polyurethane beading	

COMPLY WITH THE NECESSARY DRYING TIME ·

Generally speaking, the tiles must be left to dry for about 24 hours, although the recommendations of the manufacturer of the bonding adhesive used to lay the tiles must be followed.

CHOOSE THE RIGHT GROUTING MATERIAL ·

In accordance with the UNE EN 13888 standard, the right type of grouting material for the type of joint and surface conditions (indoors or out) must be used. The table below shows the type of grouting material to use in each case.

- CG1 – Normal cementitious grout
- CG2 – Improved cementitious grout
- RG – Synthetic resin (generally epoxy)

	INDOOR FLOORS	OUTDOOR FLOORS	INDOOR WALLS	FAÇADES
TILE JOINT	CG2	CG2 RG for contact with food, sanitary use, or contact with strong chemicals	CG1, CG2, RG in wet areas	CG2
PERIMETE JOINT	Minimum CG2	Minimum CG2 RG for contact with food, sanitary use, or contact with strong chemicals	Minimum CG2	Minimum CG2
PARTITION JOINT	Minimum CG2	Minimum CG2 RG for contact with food, sanitary use, or contact with strong chemicals	Minimum CG2	Minimum CG2
STRUCTURAL JOINT	Minimum CG2	Minimum CG2 RG for contact with food, sanitary use, or contact with strong chemicals	Minimum CG2	Minimum CG2

PREPARING & APPLYING THE GROUTING MATERIAL ·

The grouting material is prepared in a similar way to the cement-based adhesive. It is mixed with water, as per the manufacturer's indications. Use a grouting trowel to fill the joints between the tiles. Always comply with the drying times stipulated by the grout manufacturer.

REMOVE ANY SURPLUS GROUT & CLEAN THE SURFACE ·

After grouting the tiles, they must be properly cleaned to remove any surplus grout or other residues. This must be done before the grout sets. In the case of epoxy tile joints, do not use Fila Deterdek or Fila CR10 for this purpose. Shown below are recommended products for cleaning grouted surfaces.



LIMPIEZA INSTANTANEA DE RESIDUOS FRESCOS DE COLOCACIÓN

Una vez rejuntado y justo después de la primera limpieza con esponja húmeda, es posible dejar el material ya completamente limpio, evitando el posterior “empañado”.

Los productos de la marca FILA INSTANT REMOVER (para junta cementosa) y EPOXY PRO (para junta epoxi) permiten una colocación completa, impecable y conforme a la normativa UNE 138002 en el mismo día del rejuntado.

Las soluciones INSTANT son rápidas, no crean espuma, no necesitan aclarado y no decoloran las juntas.

El procedimiento a seguir es sencillo, una vez rejuntado el material y realizable la primera limpieza con esponja húmeda, se pulveriza INSTANT REMOVER (EXPOXI PRO en junta epoxi) sobre la superficie cerámica, y se deja actuar durante 1- 2 minutos. Después de este tiempo, se pasa una esponja humedecida o paño suave.

LIMPIEZA DE FINAL DE OBRA

Después de la colocación es fundamental realizar una buena limpieza con el fin de eliminar residuos de junta y en general suciedad de la obra. Para esta operación recomendamos el empleo de un detergente de acción ligeramente ácida que no despiden humos tóxicos y respete las juntas, el material y el usuario, como FILA DETERDEK. En el caso de material colocado con junta epoxi o en base resina, se aconseja realizar la limpieza final de obra con un limpiador específico de residuos epoxi, como FILA CR10.

LIMPIEZA DE MANTENIMIENTO

Limpieza Ordinaria:

Para un buen mantenimiento del pavimento se aconseja el empleo de un detergente neutro y con alto poder limpiador como FILA CLEANER que no deja residuos ni empañados, por lo que elimina las capas de suciedad orgánica.

Limpieza Extraordinaria:

Para eliminar capas de suciedad orgánica intensa y acumulada en el tiempo, se recomienda realizar una limpieza profunda con detergente FILA PS87.

El procedimiento consiste en diluir una parte del producto en hasta 10 partes de agua, según el nivel de suciedad, y dejar actuar unos 5 minutos, frotar con cepillo, recoger residuos (ideal con un aspirador de líquidos), y aclarar con abundante agua.

Existen otros muchos tipos de suciedad incrustada, en el siguiente esquema, se especifican los diferentes productos FILA recomendados, en función del tipo de suciedad a tratar.

TIPO DE SUCIEDAD INCRUSTADA	SOLUCIÓN FILA
Suciedad orgánica ligera (diaria)	CLEANER
Suciedad orgánica intensa	
Grasa, aceite, refrescos, comidas y salsas	
Goma, neumáticos	PS87
Tintes, rotulador, pintura plástica	
Residuos de detergentes, jabones y ceras	
Residuos junta epoxi	CR10
Residuos junta cementosa, salitre	DETERDEK-PHZERO
Residuos calcáreos, Rayas de metales	
Óxidos	DETERDEK-NORUST
Pintadas de grafitis	
Spay acrílicos, alquídicos, y nitrosintéticos	NOPAIN STAR
Verdín, algas, musgos, líquenes	
Ennegrecidos exteriores	ALGACID
Residuos de silicona y pegamentos	
Residuos espuma y poliuretano	
Residuos cinta adhesiva, cercos de ventosas	ZERO SIL
Cera de vela, resina de árboles	
Suciedad en la junta	FUGANET

INSTANT REMOVAL OF FRESH GROUT RESIDUES

Once tiles have been grouted and given an initial clean with a moist sponge, it is possible to leave the surface absolutely spotless, with no grout haze.

By using INSTANT REMOVER (for cement-based grout) or EPOXY PRO (for epoxy grout) by FILA, pristine surfaces that comply with the UNE 138002 standard can be achieved, the same day that they are grouted.

Both INSTANT solutions are fast and foam-free, they don't need rinsing, and they don't discolour the joints.

They are very simple to use. Once the tiles have been grouted and given an initial clean with a moist sponge, spray INSTANT REMOVER (or EPOXY PRO in the case of epoxy joints) onto the tiled surface and leave it to act for 1 to 2 minutes. Then wipe the surface with a moist sponge or soft cloth.

CLEANING NEWLY-LAID TILED SURFACES

After walls or floors have been tiled, it is important to give the surface a thorough clean to remove grout residues and building dirt. A slightly acidic product, such as FILA DETERDEK, should be used which does not release toxic fumes, harm users, or damage the tiles or tile joints. In the case of tiles laid with an epoxy or resinous grout, the surface should be cleaned with a detergent specially for epoxy materials, such as FILA CR10.

EVERYDAY CARE

Ordinary Cleaning:

To clean the floor well, use a neutral detergent with a strong cleaning power, like FILA CLEANER, which is able to remove layers of organic dirt without leaving a cloudy film.

Extraordinary Cleaning:

To remove strongly incusted layers of organic dirt, FILA PS87 cleaner should be used to give the surface a thorough clean.

Dilute one part of the product in up to 10 parts of water, depending on how dirty the surface is, and leave it to act for 5 minutes. Then rub the patches of dirt with a brush, remove any dirt residues (preferably with a vacuum cleaner for liquids), and rinse the surface with plenty of water.

There are many other types of incusted dirt. The following table shows the right product by FILA for each kind of dirt:

TYPE OF INCRUSTED DIRT	PRODUCT BY FILA
Light organic everyday dirt	CLEANER
Heavy organic dirt	
Fat, grease, oil, soft drinks, food and sauce	
Rubber, tyres	PS87
Ink, marker pen, plastic paint	
Detergent, soap or wax remains	
Epoxy grout residues	CR10
Cementitious grout residues, saltpeter	DETERDEK-PHZERO
Limescale, Metal scratches	
Rust	DETERDEK-NORUST
Graffiti	
Acrylic, alkyd & nitrosynthetic spray paint	NOPAIN STAR
Green plant stains, algae, moss, lichen	
Outdoor black mould	ALGACID
Silicon & glue residues	
Foam & polyurethane residues	
Marks made by adhesive tape or suction cups	ZERO SIL
Candlewax, tree resin	
Dirty tile joints	FUGANET

	Polivalente	Versatile	Polyvalent	Multifunktional	Настенно - напольная
	Varias gráficas	Various graphics	Plusieurs dessins	Verschiedene Grafiken	несколько видов графики
	Antihielo	Frost proof	Résistant au glace	Frostsicher	морозостойкость
	Junta 0,5 - 1,5 mm	Joint 0,5-1,5 mm	Joint 0,5-1,5 mm	Fugenbreite 0,5-1,5 mm	шов от 0,5 до 1,5 мм
	Mate	Matte	Mat	Matt	матовая
	Brillo	Gloss	Brillant	Glänzend	глянец
	Varios moldes	Various moulds	Differents moules	Verschiedene Formen	для создания неповторяемого рельефа используется несколько прессовочных форм
	Destono	Different shades	Nuances diferentes	Farbverlauf	многоцветная
	Variación en tonalidad uniforme	Uniform shade	Variation de tons uniforme	Einheitliche Farbtonunterschiede	Общая вариация по тональности
	Variación en tonalidad ligera	Slight shade variation	Variation de tons légère	Leichte Farbtonunterschiede	Легкая вариация по тональности
	Variación en tonalidad media	Medium shade variation	Variation de tons moyenne	Mittlere Farbtonunterschiede	Средняя вариация по тональности
	Variación en tonalidad pronunciada	Pronounced shade variation	Variation de tons prononcée	Starke Farbtonunterschiede	Сильная вариация по тональности
	Pavimento	Floor tiles	Carrelage sol	Bodenfliesen	только напольная
	Revestimiento	Wall tiles	Revêtement	Wandfliesen	только настенная
	Decorados y bases producidos con metales preciosos y/o esmaltes reactivos. Limpiar con productos de PH neutros y sin abrasivos	Decors produced with precious metals and/or reactive glazes. That is why they have to be cleaned with neutral and non-abrasive products	Decors fabriqués avec métaux précieux et/ou émaux réactifs. Netoyer avec produits neutres et sans abrasifs	Dekorationen mit Metallanteilen. Achtung, nicht mit säurehaltigen Reinigern pflegen	декоративные элементы произведенные с нанесением ценных металлов и реактивных эмалей на поверхность декоров. Подлежат чистке только при помощи нейтральных чистящих средств, которые не содержат абразивных микрочастиц
	Vidrio	Glass	Verre	Glas	Стекло
	Metal	Metal	Métal	Metall	Металл



Limpieza *Cleaning*

Iconografía *Iconography*

peronda

El papel utilizado para producir este catálogo proviene de bosques gestionados de forma responsable y de otras fuentes controladas que garantizan la protección del medio ambiente.
The paper used to produce this catalogue comes from responsibly managed forests and other controlled sources for greater environmental protection.



Las baldosas cerámicas una vez que llegan al final de su vida útil son un residuo inerte, que para su correcta gestión debe ser entregado a un gestor autorizado de residuos, favoreciendo su reciclado. **Once ceramic tiles reach the end of their useful life, they are inert waste. For their proper management, they should be given to an authorized waste management body for recycling purposes.**

Debido a los procesos de impresión, los colores que aparecen en este catálogo deben considerarse aproximados, y no exactos. **All colours and hues appearing in this catalogue should be considered approximate, only in view of the printing processes involved.**

Los derechos de todos los contenidos (textos, fotografías, dibujos, diseños etc) del presente catálogo son propiedad de PERONDA GROUP, S.A (o en su defecto, cuentan con los correspondientes permisos y autorizaciones de sus titulares). No está permitida la reproducción total o parcial de esta publicación, ni su tratamiento informático, ni la transmisión de ninguna forma o por cualquier medio, ya sea electrónico, mecánico, por fotocopia, por registro u otros medios, sin el permiso previo y por escrito de los titulares del copyright. **The rights of all contents (texts, photographs, drawings, designs, etc.) of this catalogue remain the property of PERONDA GROUP, S.A (or, failing that, they have the corresponding permissions and authorizations of the owners). No part of this publication may be reproduced, stored in a retrieval system, or transmitted in any form or by any means, electronic, mechanical, photocopying, recording or otherwise, without the prior written permission of the copyright holders.**

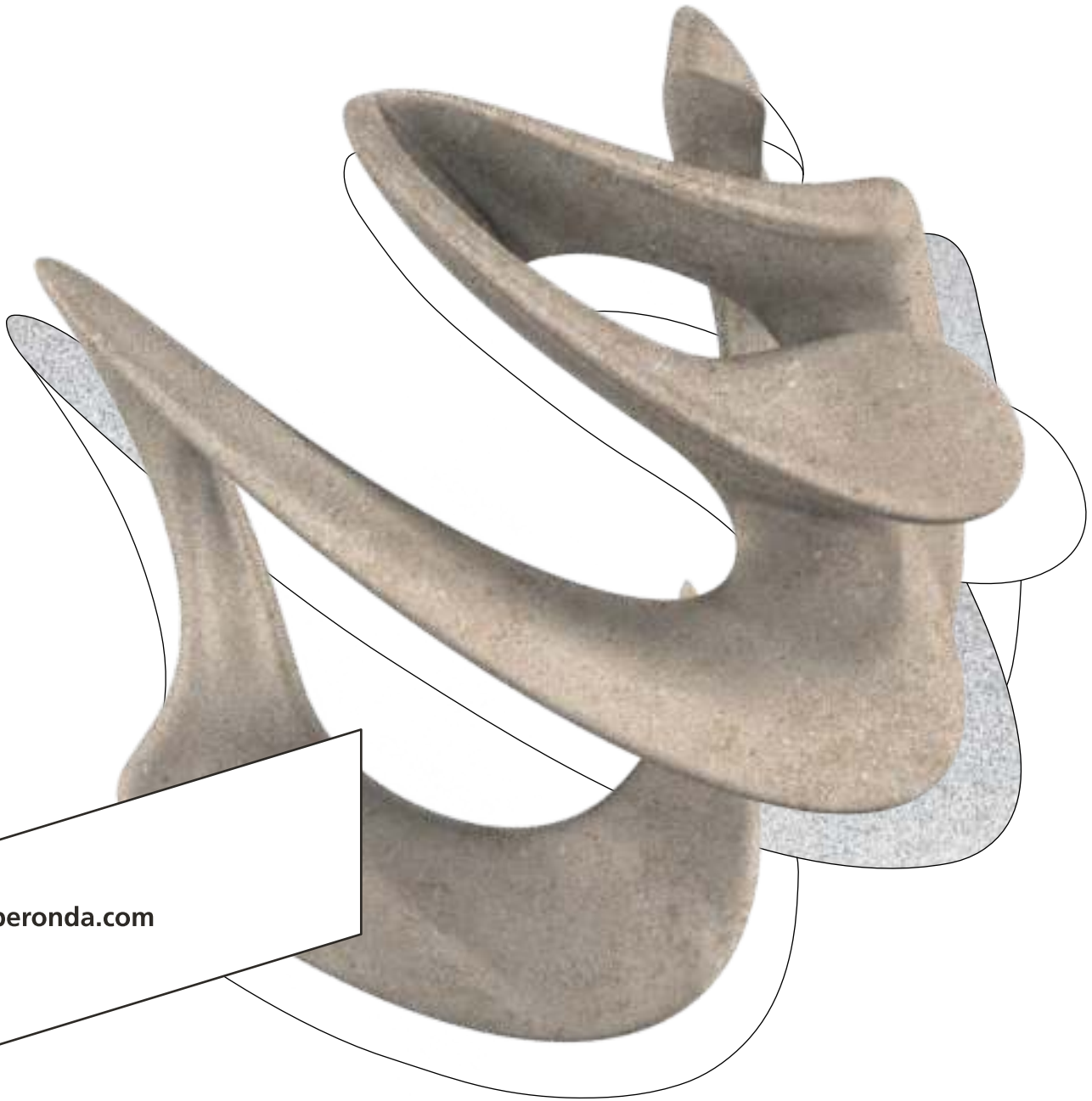

peronda.com